

W. E. Catalog

RAILWAY TRAIN DISPATCHING TELEPHONE SYSTEMS

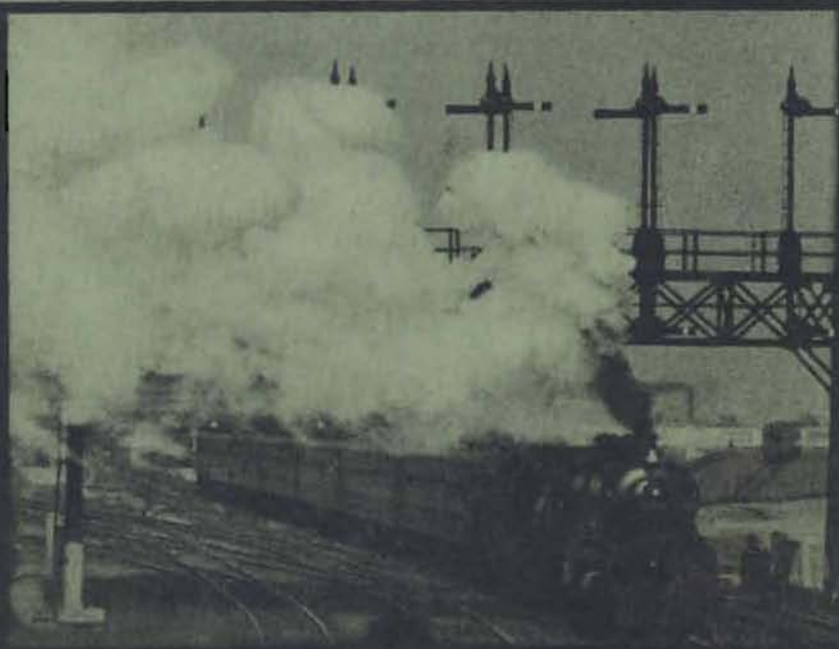

Western Electric
Products



Railway
Train Dispatching
Telephone Systems

Western Electric
Products

COPYRIGHT, 1934
Western Electric Company, Incorporated



Western Electric Railway Train Dispatching Telephone Systems

A development of Bell Telephone Laboratories, Incorporated, The Research Laboratories of the American Telephone & Telegraph Company and the Western Electric Company



No. 60AP Selector

INTRODUCTION

RAILWAY Train Dispatching Telephone Equipment has proved indispensable as a quick and reliable means of communication between the dispatcher and the various way station operators of a Train Dispatching System. The dispatcher can call selectively any one of a number of way stations on the same telephone line without producing a signal at any of the other stations.

The apparatus used in this equipment is the result of years of research and has back of it over half a century of telephone manufacturing experience. This equipment represents the highest standards of design, engineering and workmanship. Its efficiency and reliability has been proved under the most severe operating conditions.

RAILWAY TRAIN DISPATCHING TELEPHONE SYSTEMS

General Description

MODERN railroads are separated into divisions for the purpose of efficient dispatching. A division may be from 30 to 150 miles in length for busy multiple track roads or from 100 to 300 miles for single track roads where the daily traffic is light. On each division there is a dispatcher who has control of all train movements on his division. There may be from 15 to 75 stations or signal towers with which the dispatcher will want to communicate. The dispatcher has a train sheet in front of him on which he keeps a record of the time of arrival and departure or passing at each station of all trains whether passenger, freight or extra. Also the train sheet shows the engine number, the make up of the train, and the names of the crew. Whenever there is any change from the regular schedule, it is necessary for him to issue a train order to the nearest station agents or signal men which in turn is given to the trainmen. The usual method of giving a train order by telephone is as follows: The dispatcher, as he gives the order over the telephone to the operator at the distant station, writes the order in a log book and at the same time the way station operator writes the order on duplicate forms for handing to the conductor and the engineer. As a check, the operator always reads the order back over the telephone to the dispatcher who underlines each word in the log book to indicate he has received the order back as originally given. Often the order is taken by three or more operators at the same time; if so, each reads it back in turn and the dispatcher underlines his original order each time. In giving an order, all important words and numbers are both pronounced and spelled out.

Although a train dispatching system is nothing more than a long and heavily loaded selective party line, there were many new problems that had to be considered that are not met with in the commercial telephone systems. It is necessary to operate a selective device at each of the twenty-five, fifty or seventy-five way stations over a pair of wires up to 300 miles in length without interfering in any way with the telephone transmission. Of course, each installation differs from every other one as to number of way stations and length of line. To function under these varying conditions the selector must operate on very little energy but on the other hand to warrant its use for this class of service the selector must be very positive and reliable in its operation. If the line wires become open at any point, the dispatcher must be able to call stations up to the open point even under the most severe weather conditions.

The most modern selector, the Western Electric No. 60 type, is the standard on all railroads in the United States and is used in nearly all countries of Europe and in Japan, China, India, Africa, Australia, Canada and South American countries. This selector is a polarized device somewhat similar in magnetic structure to a ringer and so arranged that the armature on each plus and minus impulse advances a ratchet wheel one step. Although very sensitive, the selector is rugged and will withstand rough handling.

RAILWAY TRAIN DISPATCHING TELEPHONE SYSTEMS

CHAPTER I

LAYOUT OF SYSTEM

A Railway Train Dispatching Telephone System consists of a Dispatcher's (sending) station and a number of Way or (receiving) stations.

The dispatcher's station is equipped with telephone apparatus for receiving and transmitting messages. This consists essentially of an apparatus case containing the various parts required for protection and operation and a key equipment for signalling each way station on the circuit.

Each way station is equipped with telephone apparatus for receiving and transmitting messages, and also a selector set for signalling and for receiving time signals.

For circuit arrangement of a Railway Train Dispatching Telephone System see pages 58 and 59.

Dispatcher's Station Equipment

The following selector and telephone apparatus is recommended for the dispatcher's station. The selection of the proper equipment depends upon the total number of way stations to be installed and also the type of station selector sets and whether telephone apparatus with or without loud speaking telephone is required.

DISPATCHER'S SELECTOR APPARATUS

Quantity	Apparatus
One—	No. 60B Selector Apparatus Case.
One—	No. 61A Selector Key (17 Unit Code) or No. 61B Selector Key (27 Unit Code) or
One—	No. 62A or No. 63A Selector Key (17 Unit Code) or No. 62B or No. 63B Selector Key (27 Unit Code) or
One—	No. 60A Selector Key Case (capacity 24 stations) or No. 60B Selector Key Case (capacity 36 stations) or No. 60C Selector Key Case (capacity 48 stations) or No. 60D Selector Key Case (capacity 60 stations) or No. 60E Selector Key Case (capacity 12 stations).
One—	No. 60A Selector Key installed in above key case for each No. 60AP Selector installed at any of the way stations.
One—	No. 60B Selector Key installed in above key case for each No. 60BP Selector installed at the way stations.

NOTE: Where 60 Type Selector Keys are used, a 60B Selector Key is also required for each way station extension bell installed.

DISPATCHER'S TELEPHONE APPARATUS—HEADSET OUTFIT

Quantity	Apparatus
One—	No. 502A Subscriber Set.
One—	No. 345A Jack Box.
Three—	Each of the following: No. 386 Transmitters equipped with No. 3A Transmitter Attachments. No. 189 Receivers. No. 565, 5' 6" Cords equipped with No. 137 Plugs.
One—	No. 1B Foot Switch with
One—	No. 1A or No. 1B Foot Switch Attachment and
One—	No. 2A Foot Switch Attachment (Conduit).

DISPATCHER'S TELEPHONE APPARATUS—LOUD SPEAKING

In addition to the telephone apparatus outlined in preceding paragraphs with the exception of the No. 1B Foot Switch, the following loud speaking telephone apparatus is recommended.

Quantity	Apparatus
DC CURRENT SUPPLY	
One—	No. 12A Loud Speaking Telephone Outfit.
One—	No. 3B Foot Switch.
AC CURRENT SUPPLY	
One—	No. 6052A Amplifier (for 60 cycle, 110 volt) or, No. 6040A Amplifier (for 25 cycle, 110 volt).
One—	No. 579A Loud Speaking Telephone.
One—	No. 147AC Transmitter Arm.
One—	No. 34G Resistance.
One—	No. 3B Foot Switch.
One—	No. 6017B Key.

RAILWAY TRAIN DISPATCHING TELEPHONE SYSTEMS**Layout of System****Dispatcher's Station Equipment***(Continued)***DISPATCHER'S TIME SENDING APPARATUS**

One— No. 60A Time Sending Set.

DISPATCHER'S BATTERY REQUIREMENTS

One— No. 60B Vacuum Tube Rectifier, or Dry Cells, or Storage Cells, or Motor-Generator Set, as required for main battery source.
 Dry Cells for Local Relay Battery, 12 or 24 volts.
 No. 2B Battery Box for above dry cells.
 Transmitter Battery Requirements—4 to 5 volts.

DISPATCHER'S HAND GENERATOR BOX

One— No. 299F Hand Generator Box (for use in calling magneto portable or siding sets).

Way Station Equipment

The following Selector and Telephone Apparatus is recommended for each way station. The selection of the proper equipment depends upon whether the selectors are to be used for regular line circuits or to be operated through a repeating coil or transformer with or without extension sets; also, whether Loud Speaking Telephones are required.

WAY STATION SELECTOR APPARATUS

Quantity	Apparatus
One—	No. 160C Selector Set for use without repeating coil or transformer, or, No. 160R Selector Set for use with repeating coil or transformer.
One—	No. 60AP Selector for use where extension bells are not required.
One—	No. 60BP Selector for use where two- to four-party way station extension bells are required.
One—	No. 127J Extension Bell for each way station extension, and when using the No. 60BP Selector.

WAY STATION TELEPHONE APPARATUS (Without Loud Speaking Telephones)

One— No. 501A Desk Set Box (sub-set—equipped with key) or,
 No. 501B Desk Set Box (sub-set—arranged for foot switch).
 One— No. 1142AB Desk Stand, or,
 No. 1120C Transmitter Arm, or,
 No. 1148DA, DB, DC or DD Transmitter Arm, as required.
 One— No. 3C Foot Switch with (for No. 501B Desk Set Box).
 One— No. 1A or B Foot Switch Attachment, and
 One— No. 2A Foot Switch Attachment (Conduit).

WAY STATION TELEPHONE APPARATUS (With Loud Speaking Telephones)

One— No. 501B Desk Set Box (sub-set).
 One— No. 1142AB Desk Stand or 1148 Type Transmitter Arm.
 One— No. 6052A Amplifier (60 cycles, 110 volt) or,
 No. 6040A Amplifier (25 cycles, 110 volt)†
 One— No. 579A Loud Speaking Telephone.
 One— No. 147AC Transmitter Arm.
 One— No. 3D Foot Switch with
 One— No. 1A or B Foot Switch Attachment, and
 One— No. 2A Foot Switch Attachment.

WAY STATION EXTENSION BELL

One— No. 127J Extension Bell, for each way station extension.

WAY STATION BATTERY REQUIREMENTS

Three—Dry Cells.
 One— No. 1A Battery Box (for three dry cells).

WAY STATION PROTECTORS

As required—No. 58BP Protectors.

RAILWAY TRAIN DISPATCHING TELEPHONE SYSTEMS

Layout of System

Miscellaneous Equipment

Apparatus for miscellaneous purposes on Railway Train Dispatching Systems is described more fully in the following pages. The most important of this type of equipment is as follows:

REPEATING COIL AND TRANSFORMER

Circuits equipped with 60 Type Selectors may be operated through 341A Transformers or 70A Repeating Coils. The advantages are as follows:

1. To obtain a low resistance in the simplex telegraph leg.
2. To operate two or more simplex selector circuits with a common battery supply.
3. To operate one or more branch selector circuits from the main selector circuit without any metallic connection to it.
4. To allow two selector circuits to be used as side circuits for obtaining a composited or simplexed phantom with the physical and phantom telephone and the telegraph circuits terminated at the same or different points. The circuit on page 26 shows a general way of obtaining these conditions.

SIDING TELEPHONE SETS

Quantity	Apparatus
One—	No. 1293BC Telephone set or, No. 1317BU or DU Telephone Set or, No. 1336F or H Telephone Set.

PORTABLE TELEPHONE SETS

- | | |
|------|---|
| One— | No. 1330E or F Telephone Set or,
No. 1331E or F Telephone Set or,
No. 1332A or E Telephone Set. |
| One— | No. 3 or 5 Line Pole. |

TESTING APPARATUS

- | | |
|------|-------------------|
| One— | No. 60B Test Set. |
|------|-------------------|

RAILWAY TRAIN DISPATCHING TELEPHONE SYSTEMS

Schematic Wiring of No. 60B Selector Apparatus Case

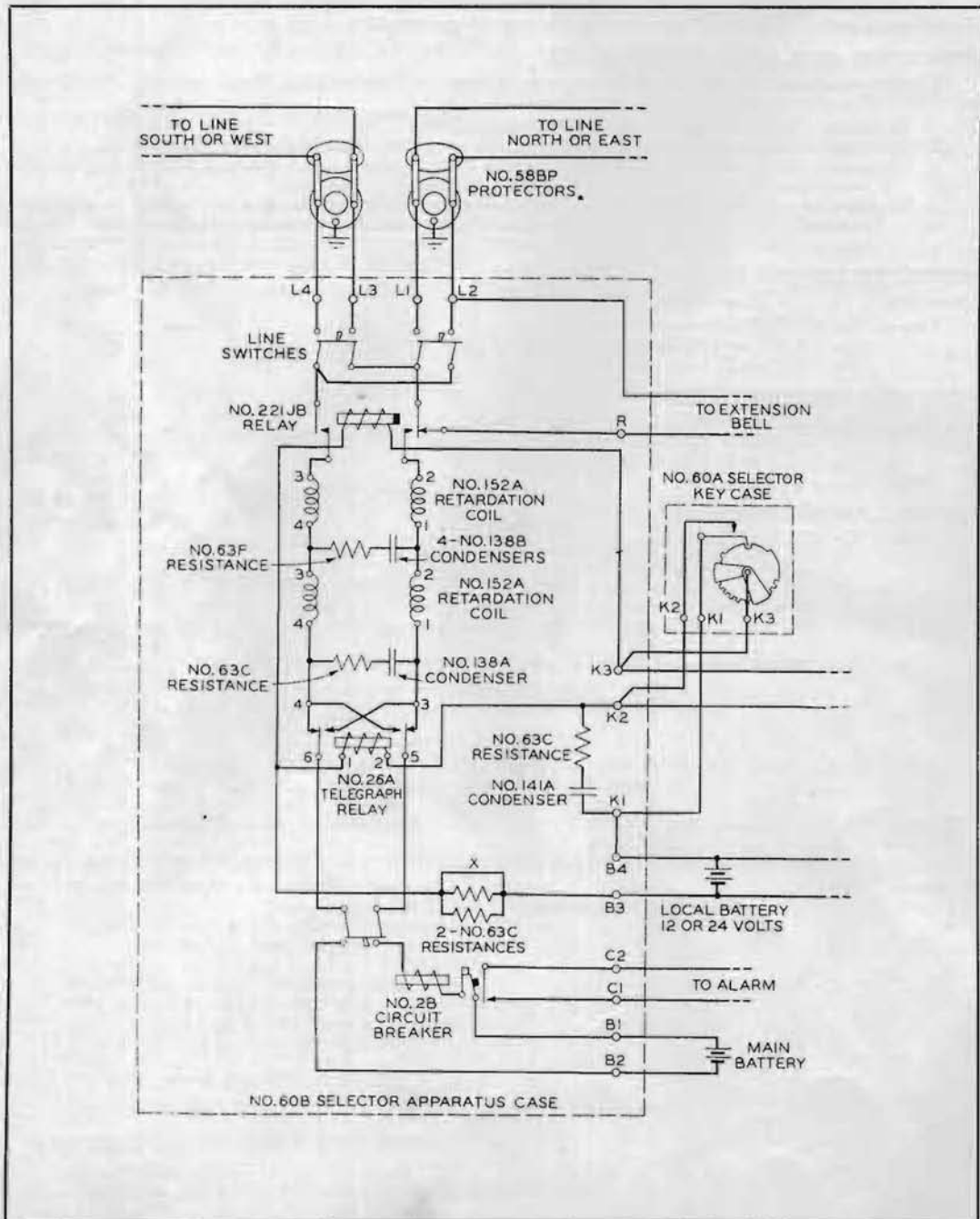

RAILWAY TRAIN DISPATCHING TELEPHONE SYSTEMS

CHAPTER II

DESCRIPTION, ADJUSTMENTS AND OPERATION OF SETS

GENERAL SEQUENCE OF OPERATIONS

The sending circuit arrangement is shown on page 6.

The sequence of operation of the various parts of the system when a call is made is as follows: A selector key operated by the dispatcher causes three groups of impulses to be sent over the line in such a manner that only the selector at the station called will be advanced to its ringing position. (Refer to page 6 for the sending circuit and page 16 for the receiving circuit.) On operating the selector key, contact K1 (B4)-K3 is closed continuously and the No. 221JB Relay is operated, connecting the main battery through the contacts of the No. 26A Relay and the two No. 152A Retardation Coils to the line wires L1 and L2; also, the key contact K1 (B4)-K2 is closed intermittently, operating the pole-changer relay (No. 26A) to send a sequence of reverse impulses to the line. This sequence of impulses, while operating all selectors on the line, will advance only the code wheel of the selector at the station called so as to close its local bell circuit. The bell at that station will ring for about two seconds, then another impulse from the calling key will release the selector and open the bell circuit. While the bell is ringing a tone or answer-back will be heard in the receiver notifying the dispatcher that the signal is operating.

Dispatcher's Selector Equipment

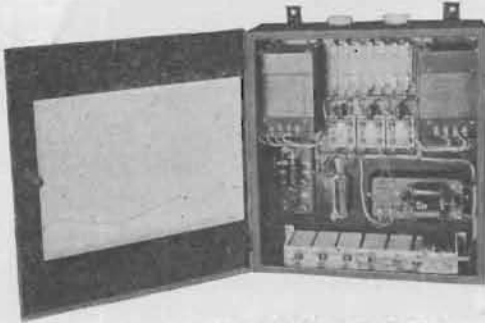

No. 60B Selector Apparatus Case—Open

- | | |
|----------------------------|-------------------------------|
| 1—No. 2B Circuit Breaker | 1—No. 26A Telegraph Relay. |
| 1—No. 221JB Relay. | 2—No. 152A Retardation Coils. |
| 1—No. 141A Condenser. | 4—No. 138B Condensers. |
| 1—No. 629A Mounting Plate. | 1—No. 138A Condenser. |
| 4—No. 63C Resistances. | 1—No. 63F Resistance. |

60B SELECTOR APPARATUS CASE

This case contains all the calling apparatus at the Dispatcher's Station except the selector keys in ordinary installations. It is a metal cabinet approximately 18" high by 16" wide by 6½" deep arranged for wall mounting. It is completely wired and provided with terminals for connecting the battery lines and selector keys as shown on page 6.

A short description of the apparatus contained in it follows:

The No. 2B Circuit Breaker is to open the main current supply lead if an excessive amount of current flows from the main battery, such as is caused by a short on the line or in any part of the sending circuit. The resistance of the circuit breaker is 2 ohms and it is normally adjusted to operate on 0.6 ampere and to non-operate on 0.4 ampere. These values can be increased or decreased by adjusting the air gap between the armature and the magnet by means of a knurled nut at the extreme end of the magnet. The circuit breaker when operated closes a local contact C1-C2. Any local alarm circuit can be connected as desired to terminals C1-C2.

The No. 221JB Relay is to connect the sending circuit to the line at the beginning of the operation of the selector key, and to disconnect the sending circuit again at the end of the operation of the selector key. This relay remains operated during the whole operation of the selector key. This relay has a normally closed contact that may be used for connecting an extension bell across the line as indicated on page 6. The resistance of the relay is 335 ohms and it should receive from .024 to .036 ampere of current for operation.

The No. 26A Telegraph Relay (pole changer) is to reverse the polarity of the main battery so that each succeeding impulse sent over the line is in the opposite direction to the preceding one. The resistance of the relay is 25 ohms. It should receive from 0.32 to 0.48 ampere of current for operation.

The No. 152A Retardation Coils and the **No. 138B (1¼ mf) Condensers** are to smooth out the impulses of the current used for operating the selectors while calling, so as not to cause an objectionably sharp click in the receiver, but merely a dull thump that is not objectionable and does not interfere with the telephone transmission. The resistance of these coils is 20 ohms each, or a total of 40 ohms for the two coils. The No. 138A and No. 141A Condensers with resistances are for spark "take-up."

RAILWAY TRAIN DISPATCHING TELEPHONE SYSTEMS

Dispatcher's Selector Equipment (Continued)

The No. 58BP Protectors which are furnished with this apparatus case should be used to protect the inside apparatus against damage from high voltages by providing a shunt path from each side of the line through an air gap between the blocks to a ground connection. The spacing between the blocks of the protector is such that a breakdown will occur on an average of 700 volts, thus a low impedance path is provided to lead the high voltages off to ground rather than through the calling or telephone apparatus.

Selector Keys

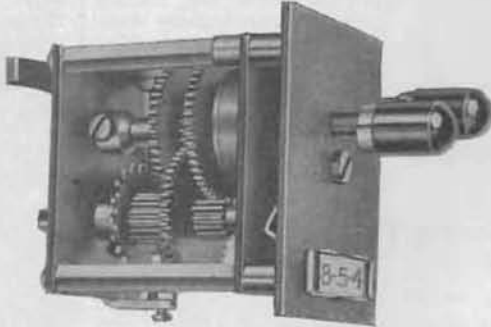

No. 60A Selector Key



No. 61A Selector Key

GENERAL

The function of the selector key is to control the operation of the stick relay (No. 221JB) and the pole-changer relay (No. 26A), so that the necessary sequence of current impulses to operate the selector at the station desired will be transmitted to the main line wires, see page 6.

There are three types of keys that may be used, (1) the 60 type selector key requiring an individual key for each selector, (2) the 61 type selector key provided with lever arms for setting the code as required when making a call, and (3) the 62 and 63 type selector keys provided with small button keys for setting the code as required when making a call.

No. 60 TYPE SELECTOR KEYS

The 60 type are individual keys having a clock spring operating an impulse wheel through a train of gears, with the speed controlled by a governor.

The keys are mounted in oak cases (page 94) coded Nos. 60A, B, C, D and E Selector Key Cases for mounting 24, 36, 48, 60 or 12 No. 60A or 60B Selector Keys or No. 50A Selector Key Space, respectively.

The No. 60 Type Selector Keys mount in the No. 60 Type Selector Key Case and can easily be removed with a screw driver by turning the screw under the handle counter clockwise. The keys, when mounted, make contact with the springs in the back of the key case. When a key is operated by turning the handle one-quarter turn and then releasing, it should return automatically to its normal position. The speed at which it returns can be increased or decreased by bending in or out the springs which carry the weights of the regulating governor.

No. 60A SELECTOR KEY

The No. 60A Selector Key is for use with the No. 60AP Selector when set for the code numbers given in Table No. 1 (page 10). It may be set for any of the code numbers given in Table No. 1 by adjusting its segments as described in detail hereafter. In this series of settings the total number of current impulses for any code is seventeen. The governor springs for the No. 60A Selector Key is so adjusted that the impulse wheel will make one revolution in not less than $7\frac{1}{2}$ seconds and not more than 8 seconds.

No. 60B SELECTOR KEY

The No. 60B Selector Key is for use with the No. 60AP Selector when set for the code numbers in Table No. 2 (page 10), and with the No. 60BP Selector when set for the code numbers given in Table No. 1 for the No. 60BP Selector. It may be set for any of the code numbers given in Table No. 2 or 1, by the adjustment of its segments in a manner similar to that explained in detail for the No. 60A Selector Key, with the exception that the total number of impulses is increased by 10 for the 27 step code settings of the No. 60AP Selector and that a flat segment is used to reduce the total number of impulses to 17, 19, 21 or 23 for the A, B, C and D contacts for the 17 step No. 60BP Selector. The governor springs for the No. 60B Selector Key are so adjusted that the impulse wheel will make one revolution in not less than 9 seconds and not more than $9\frac{1}{2}$ seconds.

RAILWAY TRAIN DISPATCHING TELEPHONE SYSTEMS

Selector Keys (Continued)

METHOD OF SETTING CODES FOR No. 60 TYPE KEYS

In setting the segments on the impulse wheel of the key, each closure and each opening of the contacts count one. Two styles of segments are provided, one a flat segment which closes the contacts while the inner spring passes over it; the other segment with a bent-up part which engages with the insulated piece on the outer spring, raising this spring sufficiently to keep the contacts open while the outer spring passes over.

Each key requires two segments to give the three sets of impulses. If the first number in the code is odd, a flat segment is required, while a segment with the bent-up part is required if the first number is even. If the last number in the code is even, a flat segment is required, while a segment with the bent-up part is required if the last number is odd. Thus two like segments or one of each kind may be required to give the code setting. The first segment is set so that the inner contact spring, in passing over the first set of teeth on the impulse wheel gives the number of closures and openings of the contacts represented by the first number in the code. The other segment is set so that the contact springs, in passing over the third set of teeth on the impulse wheel, give the number of closures and openings of the contacts as represented by the last number in the code. Since the total number of impulses for any three digit code combination is always the same in the same table, it follows that if the first and the last numbers are set the middle one will be automatically determined.

For example, to set the No. 60A Selector Key for selecting station 8-5-4, begin at the first tooth and count 8 (first number in code) in a clockwise direction, counting one for each tooth and one for each space, in this case 4 teeth and 4 spaces. As the last count was a space, take a segment with the bent-up part and place it so as to keep the contact in the same position while passing over the segment, as on the last count. This segment is set approximately flush with the edge of the next tooth, so that the outside contact spring will be off this segment before the inner contact spring strikes the next tooth.

To set the other segment, begin at the ringing position and count 4 (last number in code) in a counter-clockwise direction, counting one for each space and one for each tooth, in this case two spaces and two teeth. As the last count was on a tooth, set the edge of a flat segment on the center of this tooth. The number of closures and openings of the contact while the inner contact spring passes between the two segments, is the middle number in the code (5 in this case).

METHOD OF SETTING No. 60 TYPE KEYS FOR TIME SENDING

To set the No. 60A Selector Key so that all No. 60AP Selectors will be advanced to their time receiving position, place a flat segment bridging from the center of the first tooth to the center of the fourth tooth. This gives, after the first long impulse, 22 regular impulses in succession.

The No. 60B Selector Key is set in a similar manner except the total number of impulses is 27 for the station codes, Table No. 2, page 10, and 32 total impulses for time sending.

No. 61A SELECTOR KEY

The No. 61A Selector Key is for use as a master key at test boards and switchboards; also at way stations on intercalling circuits. It may be set for any of the code numbers given in Table No. 1 for all selectors set for the 17 step code by moving the levers, extending through the cover, to the code desired. As in the case of the No. 60 Type Keys, the middle number of the code is automatically determined by setting the first and the third numbers.

The first lever on the left side is used only with the No. 60BP Selector and normally is placed for station "A" and should be left in this position when used in connection with the No. 60AP Selectors. When used with the No. 60BP Selectors it should be moved to the B, C and D position, corresponding with the code of the station desired.

To make a call, the second lever is placed opposite the first number of the code of the selector desired. The third lever is placed opposite the last number of the code of the selector desired. The right lever is then moved down to the bottom of its slot and released. The key then operates to give the same sequence of impulses as the No. 60A Key.

The No. 61A Selector Key may be set to call all stations on the line equipped with No. 60AP Selectors (17 step) and all stations connected to the "A" contact of the No. 60BP Selectors (17 step by setting the second and third levers each on zero. The key then sends out 17 consecutive impulses to step all selectors to the first ringing contact.

The No. 61A Selector key makes one complete operation in $7\frac{1}{2}$ to 8 seconds. The speed is changed by bending the governor springs, at the right end, in to increase and out to decrease the speed.

Three terminals on the bottom, designated K1, K2 and K3, connect to the corresponding terminals in the No. 60B Selector Apparatus Case shown on page 6.

No. 61B SELECTOR KEY

The No. 61B Selector Key is similar to the No. 61A Selector Key except it is arranged for the code numbers given in Table No. 2 (page 10) for selectors set for the 27 step code. The key makes one complete operation in 9 to $9\frac{1}{2}$ seconds.

RAILWAY TRAIN DISPATCHING TELEPHONE SYSTEMS

CODE SETTINGS FOR SELECTORS

TABLE No. 1

Total Steps in Each Code—17.

Total code settings for the No. 60AP Selector—78.

Code settings for the No. 60BP Selector with No. 60AP Selectors on the same line are marked with a star—28.

Additional code settings for the No. 60BP Selector with no No. 60AP Selectors on the same line are marked with a dot—18.

2-2-13									
2-3-12	3-2-12								
2-4-11	3-3-11	4-2-11							
2-5-10	3-4-10	4-3-10	.5-2-10						
2-6-9	3-5-9	4-4-9	.5-3-9	6-2-9					
2-7-8	3-6-8	4-5-8	.5-4-8	6-3-8	*7-2-8				
2-8-7	3-7-7	4-6-7	.5-5-7	6-4-7	*7-3-7		*8-2-7		
2-9-6	3-8-6	4-7-6	.5-6-6	6-5-6	*7-4-6		*8-3-6	*9-2-6	
2-10-5	3-9-5	4-8-5	.5-7-5	6-6-5	*7-5-5		*8-4-5	*9-3-5	
2-11-4	3-10-4	4-9-4	.5-8-4	6-7-4	*7-6-4		*8-5-4	*9-4-4	
2-12-3	3-11-3	4-10-3	.5-9-3	6-8-3	*7-7-3		*8-6-3	*9-5-3	
2-13-2	3-12-2	4-11-2	.5-10-2	6-9-2	*7-8-2		*8-7-2	*9-6-2	
*10-2-5									
*10-3-4		*11-2-4							
*10-4-3		*11-3-3		*12-2-3					
*10-5-2		*11-4-2		*12-3-2		*13-2-2			

TABLE No. 2

Total Steps in Each Code—27.

Total code settings for the No. 60AP Selector—241.

Code settings for the No. 60BP Selector with No. 60AP Selectors on the same line are marked with a star—147.

Additional settings for the No. 60BP Selector with no No. 60AP Selectors on the same line are marked with a dot—38.

2-5-20	3-4-20	4-3-20	.5-2-20						
2-6-19	3-5-19	4-4-19	.5-3-19	6-2-19					
2-7-18	3-6-18	4-5-18	.5-4-18	6-3-18	*7-2-18				
2-8-17	3-7-17	4-6-17	.5-5-17	6-4-17	*7-3-17			*8-2-17	
2-9-16	3-8-16	4-7-16	.5-6-16	6-5-16	*7-4-16			*8-3-16	
2-10-15	3-9-15	4-8-15	.5-7-15	6-6-15	*7-5-15			*8-4-15	
2-11-14	3-10-14	4-9-14	.5-8-14	6-7-14	*7-6-14			*8-5-14	
2-12-13	3-11-13	4-10-13	.5-9-13	6-8-13	*7-7-13			*8-6-13	
2-13-12	3-12-12	4-11-12	.5-10-12	6-9-12	*7-8-12			*8-7-12	
2-14-11	3-13-11	4-12-11	.5-11-11	6-10-11	*7-9-11			*8-8-11	
2-15-10	3-14-10	4-13-10	.5-12-10	6-11-10	*7-10-10			*8-9-10	
2-16-9	3-15-9	4-14-9	.5-13-9	6-12-9	*7-11-9			*8-10-9	
2-17-8	3-16-8	4-15-8	.5-14-8	6-13-8	*7-12-8			*8-11-8	
2-18-7	3-17-7	4-16-7	.5-15-7	6-14-7	*7-13-7			*8-12-7	
2-19-6	3-18-6	4-17-6	.5-16-6	6-15-6	*7-14-6			*8-13-6	
2-20-5	3-19-5	4-18-5	.5-17-5	6-16-5	*7-15-5			*8-14-5	
2-21-4	3-20-4	4-19-4	.5-18-4	6-17-4	*7-16-4			*8-15-4	
2-22-3	3-21-3	4-20-3	.5-19-3	6-18-3	*7-17-3			*8-16-3	
2-23-2	3-22-2	4-21-2	.5-20-2	6-19-2	*7-18-2			*8-17-2	
*9-2-16									
*9-3-15	*10-2-15								
*9-4-14	*10-3-14	*11-2-14							
*9-5-13	*10-4-13	*11-3-13	*12-2-13						
*9-6-12	*10-5-12	*11-4-12	*12-3-12	*13-2-12					
*9-7-11	*10-6-11	*11-5-11	*12-4-11	*13-3-11	*14-2-11				
*9-8-10	*10-7-10	*11-6-10	*12-5-10	*13-4-10	*14-3-10			*15-2-10	
*9-9-9	*10-8-9	*11-7-9	*12-6-9	*13-5-9	*14-4-9			*15-3-9	
*9-10-8	*10-9-8	*11-8-8	*12-7-8	*13-6-8	*14-5-8			*15-4-8	
*9-11-7	*10-10-7	*11-9-7	*12-8-7	*13-7-7	*14-6-7			*15-5-7	
*9-12-6	*10-11-6	*11-10-6	*12-9-6	*13-8-6	*14-7-6			*15-6-6	
*9-13-5	*10-12-5	*11-11-5	*12-10-5	*13-9-5	*14-8-5			*15-7-5	
*9-14-4	*10-13-4	*11-12-4	*12-11-4	*13-10-4	*14-9-4			*15-8-4	
*9-15-3	*10-14-3	*11-13-3	*12-12-3	*13-11-3	*14-10-3			*15-9-3	
*9-16-2	*10-15-2	*11-14-2	*12-13-2	*13-12-2	*14-11-2			*15-10-2	
*16-2-9									
*16-3-8	*17-2-8								
*16-4-7	*17-3-7	*18-2-7							
*16-5-6	*17-4-6	*18-3-6	*19-2-6						
*16-6-5	*17-5-5	*18-4-5	*19-3-5	*20-2-5					
*16-7-4	*17-6-4	*18-5-4	*19-4-4	*20-3-4					
*16-8-3	*17-7-3	*18-6-3	*19-5-3	*20-4-3					
*16-9-2	*17-8-2	*18-7-2	*19-6-2	*20-5-2					

RAILWAY TRAIN DISPATCHING TELEPHONE SYSTEMS

Selector Keys (Continued)

No. 62A Selector Key

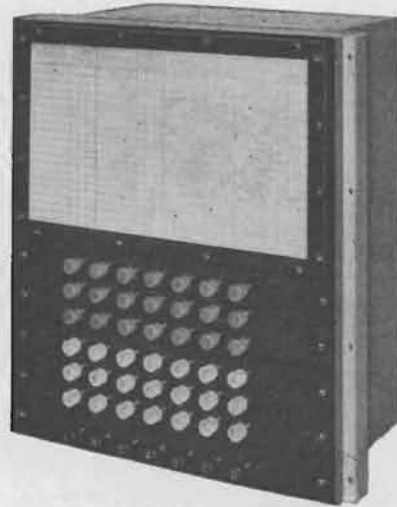

No. 63B Selector Key

Nos. 62 AND 63 TYPE SELECTOR KEYS

These selector keys are master calling keys arranged to operate any or all selectors on a line to their ringing position by pushing one small locking key in each of the two groups of keys.

The Nos. 62A and 62B Selector Keys are arranged for desk or table mounting, and the main apparatus unit is arranged so that it can be removed from its base by means of a jack connection (see page 12). The overall dimensions are approximately 12½" high, 10¼" wide, 6½" deep. The metal frame and cover are finished in black.

The Nos. 63A and 63B Selector Keys are arranged for mounting in the face equipment of a 604 PBX switchboard between the stiles (10¼" face mounting) and are arranged so that they may be removed from the face equipment of the switchboard either from the front or rear. The metal frame and cover are finished in aluminum. The overall dimensions of the keys are approximately 10⅝" high, 9¾" wide, 6¼" deep.

The Nos. 62A and 63A Selector Keys provide means for calling all selectors in the 17 step selector code as given in Table No. 1, page 10. These keys have two groups of 14 keys each and one group of 7 keys.

The Nos. 62B and 63B Selector Keys provide means for calling all selectors in the 27 step selector code as given in Table No. 2, page 10. These keys have two groups of 21 keys each and one group of 7 keys.

Operation

The operating principle is the same for each type and capacity. With the manually operated selector keys, a separate key is used to call each selector. With the new key unit, it is possible to call every selector within the capacity of the unit by depressing combinations of push keys in the face of the key cabinet. The process of calling any given selector consists of depressing a button in the top (red) group of push keys corresponding to the first number in the desired code, and a second push key in the middle (white) group corresponding to the last number in the selector code. Upon depressing the second push key, circuits are set up which cause a motor-driven brush to sweep around a series of segments arranged in a circle. Page 12 shows this mechanism clearly. The operation of the push keys further establishes connections to certain segments so that as the brush revolves the correct sequence of impulses is sent out for operating the selector whose code number is being called.

A small lamp located behind the square space in the lower center of the designation card remains lighted while the key is in operation.

The black keys designated A, B, C and D in the bottom row of both capacities of the key unit make it possible to produce selective ringing at the called selector. In other words, by depressing one of the four "letter" keys in question, the called selector will ring independently one of four annunciator bells local to the selector.

A schematic diagram of the smaller capacity key is shown on page 13.

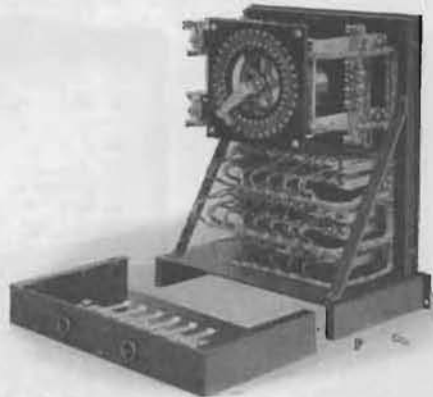
RAILWAY TRAIN DISPATCHING TELEPHONE SYSTEMS*Selector Keys (Continued)*

No. 62A Selector Key—Rear View, cover removed

Drive

Each selector key also has a distributor panel with a telechron motor driving a brush arm, carrying a brush which wipes over a commutator consisting of 70 small segments. On the front of this panel a designation card is provided for listing the keys to be operated to make the selector call for each station.

110-120 volts, 50-60 cycles is required for the operation of the Telechron motor used in these selector keys. This current is connected directly to the terminals in the base of the Nos. 62A and 62B Selector Keys, and through a No. 335B Transformer for the Nos. 63A and 63B Selector Keys. For the Nos. 63A and 63B Selector Keys, the No. 335B Transformer must be ordered separately and is used to step down the voltage to 24 volts so as not to require special insulation in the wiring for the keys in the PBX switchboard. The selector keys are arranged to use either 12 or 24 volts D.C. for the local operation of the relays and lamp. When a 24 volt battery is used, the strap shunting the 45 ohm resistor must be removed.

Features and Advantages

1. All selectors may be set for receiving time signals by depressing key No. 1 in the first (red) group and key No. 1 in the second (white) group.
2. All selectors may be operated for a master call by depressing key No. 0 in the first (red) group and key No. 0 in the second (white) group.
3. Selectors may be called in groups by depressing corresponding keys in the first and second groups of keys.
4. Since the keys used for calling are of the locking type, the last keys operated indicate the last call made.
5. If it is desired to repeat the call of any given selector, it may be accomplished by depressing the black key "S."
6. Should the operator for any reason wish to prolong the ringing of the bell at a station, this can be accomplished by holding the "L" and "R" keys in the operated position as soon as the "answer back" tone is heard.
7. If, after a call is started, it is desired to break it up, this may be done by pushing the "R" key which will prevent the impulses from going out.
8. The new selector key unit is extremely flexible in that only one unit is necessary to call any number of selectors within the capacity of the unit. When, in the course of time, additional selectors, within the capacity of the unit, are added to the system they are handled by the original key without any changes or additions.
9. The new selector key is interchangeable with the present Western Electric Nos. 60 and 61 Type Selector Keys and may be connected in multiple by connecting like terminals together, or may be substituted entirely for them.
10. One dispatcher, from a given position using a single key unit, may operate two or more systems during light load since the same key need simply be switched from one system to another as desired.
11. Uniformity of impulse sending is insured by the use of a synchronous motor sweeping a brush arm over uniformly spaced contact segments.
12. The key is entirely self contained, all relays and other mechanism being mounted compactly within its housing.

RAILWAY TRAIN DISPATCHING TELEPHONE SYSTEMS

Selector Keys (Continued)

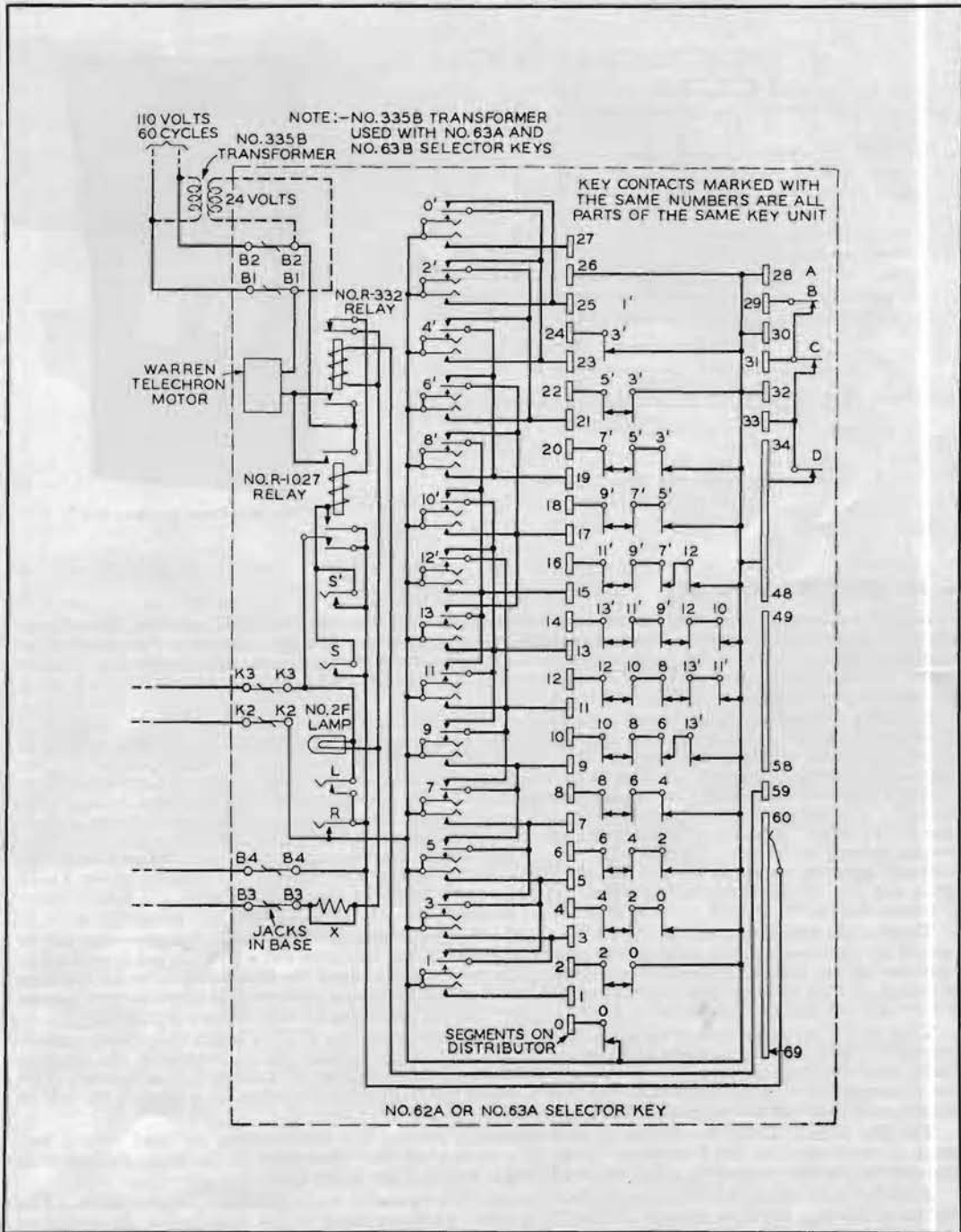

Schematic of No. 62A or 63A Selector Key

RAILWAY TRAIN DISPATCHING TELEPHONE SYSTEMS

No. 60A Time Sending Set

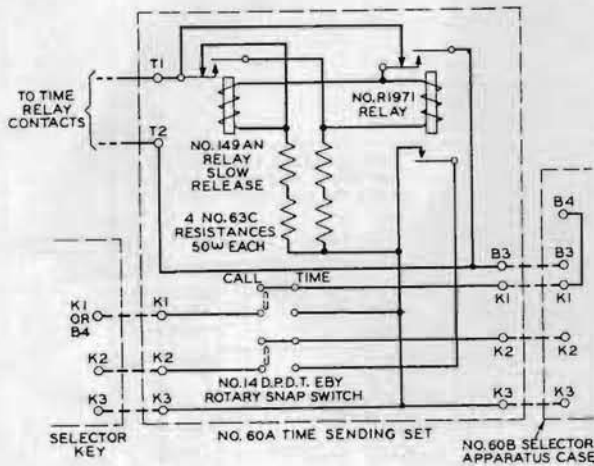

Schematic of No. 60A Time Sending Set



No. 60A Time Sending Set

No. 60A TIME SENDING SET

In addition to the operation of selecting a station as described for the No. 60AP selector, the selector is provided with a second or time ringing terminal for receiving time. For this purpose a time sending set is used with the No. 60B Selector Apparatus Case for sending the time signals over selector circuits. The set consists of a No. 149AN and an R1971 Relay, a switch, and four No. 63C Resistances mounted in a black finished steel case approximately $6\frac{1}{4}'' \times 6\frac{1}{4}'' \times 6\frac{1}{4}''$.

For normal operation of the circuit, the time switch is operated to the "calling position". When it is desired to send time signals, a Selector Key set to send 22 consecutive impulses for the 17 step code or 32 impulses for the 27 step code is operated. This steps all the code wheels of the No. 60AP Selectors on the circuit up to the time receiving position (code wheel contact within one step of closing the second or time contact) where it is retained by an insulated "time arm". The time switch is then operated to the "time position". This completes the circuit between terminals K1 and K3 and connects K2 to the pulsing contact of the R1971 Relay. Closing circuit to terminals K1 and K3 operates the No. 221JB Relay which connects the main battery to the line. Then as a time-repeating relay in the telegraph circuit operates and completes the circuit between terminals T1 and T2, the R1971 Relay will operate and on the opening of the T1-T2 Circuit, the No. 149AN Relay will operate. On the second closure of the T1-T2 Circuit, the R1971 Relay will release and on the second opening of the T1-T2 Circuit the No. 149AN Relay will release.

Thus on the first closure of the T1-T2 Circuit the No. 26A Relay in the selector apparatus case will be operated by the closure of the pulsing contact of the R1971 Relay and send out a positive pulse on the line to advance all the No. 60AP Selectors one step. This momentarily closes the time contacts on all selectors and causes all bells to tap. The selectors on the line then fall back to a position within one step of closing the time contact and are held there as before by the "time arm" engaging with the holding spring.

Then as the time-repeating relay operates a second time to close the T1-T2 Circuit the pulsing contact of the R1971 Relay will be opened and release the No. 26A Relay to send out an impulse of the opposite polarity over the line, operating all the No. 60AP Selectors and causing all bells to tap as before. This series of operations is repeated for each two operations of the time-repeating relay, thus causing the bell to tap once each time the time-repeating relay operates.

The No. 149AN Relay is sufficiently slow release to prevent the time sending set from pulsing fast enough to cause the No. 60AP Selectors on the line to step off the "time arm" if the time sending set is connected to the time-repeating relay when telegraph impulses are being sent.

After the time signals have been sent, the time switch is operated to the selector calling position. The selectors on the line are then stepped off the "time arm" by the sending of four impulses or the operation of any selector key. The circuit is then in condition for regular calling.

The time sending set functions on the local battery of either 12 or 24 volts. The "time arm" of the No. 60AP Selector is insulated from the bell circuit to open the answer-back circuit and thus prevent the tone from interfering with telephone conversation while time signals are being sent.

RAILWAY TRAIN DISPATCHING TELEPHONE SYSTEMS

Dispatcher's Telephone Equipment



No. 502A Sub. Set



No. 345A Jack Box

No. 502A SUBSCRIBER SET

The No. 502A Subscriber Set is a high efficiency set, designed with an anti-side tone feature arranged so that the dispatcher is at all times insulated from the line.

As the dispatcher wears his receiver continuously, his battery circuit is closed a large portion of the time. With the anti-side tone feature, the dispatcher's voice and other noises in the dispatcher's office are kept out of his receiver.

The two induction coils in the set insulate the dispatcher's telephone equipment from the line. These coils have a break-down test of approximately 1000 volts AC.

The arrangement of the condensers keeps down the thumps from signalling impulses, thus protecting the dispatcher's ears.

No. 345A JACK BOX

The No. 345A Jack Box permits the use of two operators' telephone sets in parallel.

Way Station Selector Equipment

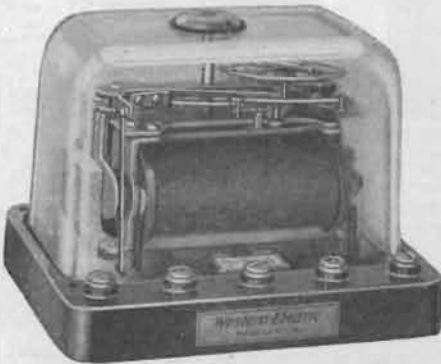

No. 60AP Selector

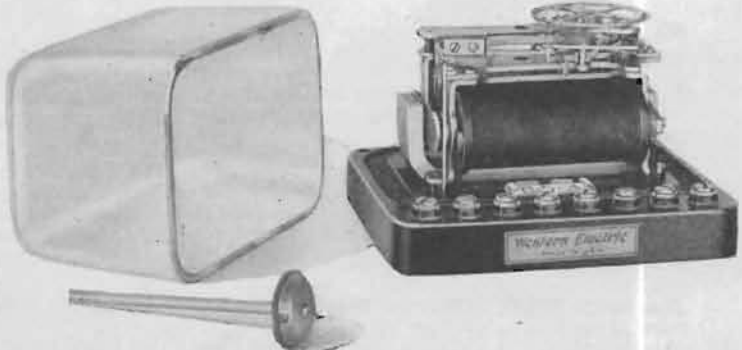

No. 60BP Selector

SELECTOR SETS

No. 160C Selector Set.

No. 160R Selector Set.

The No. 160C Selector Set replaces the Nos. 160AC and 160BC Selector Sets, and the No. 160R Selector Set replaces the Nos. 160AR and 160BR Selector Sets formerly furnished.

The sets are arranged to hold the selector and are completely wired and provided with terminals for connecting the line and local battery wires, as shown on page 16, for the No. 160C Selector Set when equipped with a No. 60AP Selector, and the 160R Selector Set when equipped with a No. 60BP Selector.

The Nos. 160C and 160R Selector Sets do not include the No. 60AP or No. 60BP Selector as part of the equipment. The selector desired must be ordered separately.

No. 160C SELECTOR SET

The No. 160C Selector Set is for use on standard circuits where condensers are required in series with the No. 60AP or No. 60BP Selector.

No. 160R SELECTOR SET

The No. 160R Selector Set is for use in a repeating coil circuit where no condenser is required in series with the selector. This set is the same as the No. 160C Selector Set except that the No. 138B Condenser is omitted.

RAILWAY TRAIN DISPATCHING TELEPHONE SYSTEMS

Way Station Selector Equipment (Continued)

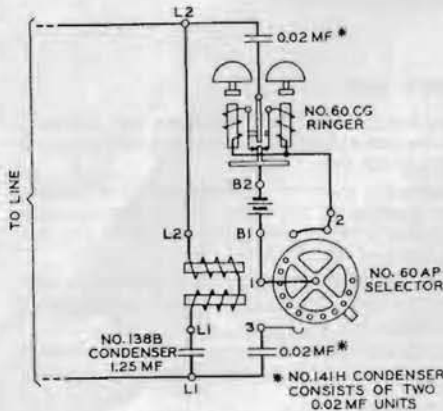

Schematic 160C Selector Set
Note: Selector not furnished with Sets

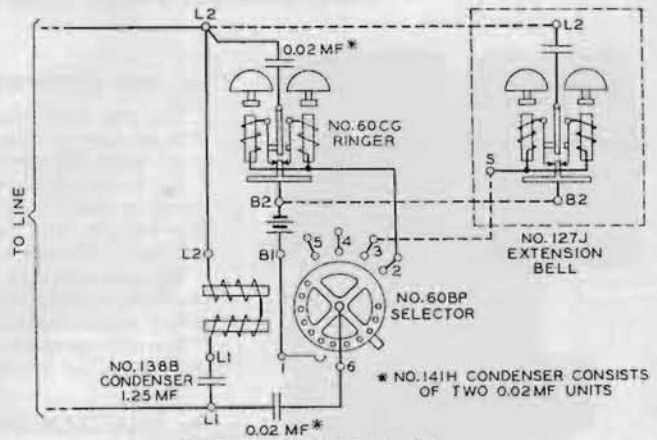

Schematic 160R Selector Set

No. 60CG RINGER

The function of the No. 60CG Ringer which is a part of the above selector sets is to signal the way station operator and also to give the time signals. This ringer is a vibrating direct current type, operating from the transmitter battery and is provided with contact springs for opening its own circuit intermittently.

The resistance of each ringer spool is 8 ohms and the ringer is adjusted to operate on the same battery as the telephone equipment.

60 TYPE SELECTORS**General**

The function of the selector is to provide a quick and reliable means to call selectively one of a large number of way stations on the same telephone line without producing a signal at the other stations.

The D.C. resistance of the 60 Type Selector is 21,000 ohms. The selector may be operated in series with a $1\frac{1}{4}$ or $1\frac{1}{2}$ mf condenser or through a No. 341A Transformer or No. 70A Repeating Coil without a condenser. The impedance of the selector and condenser at the operating frequency of $3\frac{1}{2}$ cycles is approximately 35,000 ohms. The impedance of the selector at talking frequency, 800 cycles per second, is approximately 2 megohms. Thus the loss in telephone transmission due to the selector bridge on the line is negligible.

No. 60AP SELECTOR (Not included with selector sets)

The No. 60AP Selector, shown on page 15, is of the step-by-step type and is operated by a definite code or sequence of alternating or reverse current impulses. It consists of a mechanism unit mounted on a magnet unit with a bakelite base and a glass cover.

The code wheels are set so that the same total number of steps is necessary to advance the code wheel to the ringing position on all selectors that are to be used on the same line. With the number of holes provided in the code wheel, this number of total steps may be any number from 8 to 32, which number would give a total of 6 to 378 code settings, respectively. The No. 60AP Selector, however, is normally set for a total of 17 steps which number gives a total of 78 code settings. Unless selectors are ordered for some other code setting than those given in Table No. 1, page 10, the selector is not stepped up by 17 consecutive impulses when selecting a station but by 3 sets of successive impulses totalling 17 in number as indicated in Table No. 1. (This number of impulses, 17, does not count the restoring impulse.)

The code pins on each selector are located so that after the first set of impulses the code wheel will be in position for the holding spring to engage with the first code pin. The second code pin is located so that after the second set of impulses the code wheel will be in position for the holding spring to engage with the second code pin. The third set of impulses then advances the code wheel so that the permanent code pin is in position to engage with the holding spring and at the same time the contact spring is directly over and makes contact with the first ringing terminal thus completing the bell circuit. Each selector is capable of being set for any station number given in Table No. 1, page 10, without any change other than the location of the two code pins in the code wheel.

In order to take care of cases where a greater number of code settings are required than those given in Table No. 1, the code settings for a No. 60AP Selector for 27 total steps in each code are given in Table No. 2, page 10, which gives a total of 241 code settings.

RAILWAY TRAIN DISPATCHING TELEPHONE SYSTEMS

Way Station Selector Equipment (Continued)

No. 60BP SELECTOR (Not included with selector sets)

The No. 60BP Selector, page 15, is known as the multiple contact selector and differs from the No. 60AP Selector in that it is equipped with four selector ringing terminals instead of one so that any one of four local signal circuits can be closed by the same selector independently. Also, the selector is not equipped with a terminal for receiving time signals.

The method of setting the code numbers and the method of operation are the same as described for the No. 60AP Selector.

The terminals on the No. 60BP Selector are known by the letters A, B, C and D. Terminal A is the first terminal engaged by the contact spring on the code wheel as the code wheel is advanced. The last group of impulses in the code setting for selecting the first or A contact, is increased by two impulses to select the B contact, four impulses to select the C contact, and six impulses to select the D contact. The numbers marked on the code card on the selector indicate the code setting for the A contact. For example, a selector having a code setting of 8-5-4 for the first contact will be marked 8-5-4 and the contacts will be known as 8-5-4 A, 8-5-4 B, 8-5-4 C and 8-5-4 D.



No. 127J Extension Bell



No. 160 Type Selector Set

No. 501A Type Desk Set Box
Cover Removed**No. 127J EXTENSION BELL**

This bell is used as an extension signal in connection with the No. 60BP Selector. The No. 60CG Ringer in the No. 160C or R Selector Set in which the No. 60BP Selector is mounted, gives a signal for the first or A ringing terminal. One of these extension bells is required for each signal desired in addition to the one in the selector set.

The No. 127J Extension Bell consists of a No. 60CG Ringer and a condenser mounted in an oak box. These sets are arranged to be connected directly to the terminals in the No. 160C or R Selector Set as follows:

Terminal L2 of the extension bell to be connected to terminal L2 in the selector set. Terminal B2 of the extension bell to be connected to terminal B2 in the selector set. Terminal S of the extension bell to be connected to terminal 3 or 4 or 5 on the base of the 60BP Selector as desired. These connections are shown on a circuit label furnished with the selector set and shown on page 16.

Way Station Telephone Equipment

No. 501 TYPE DESK SET BOXES

The Nos. 501A and B Desk Set Boxes are high efficiency sets designed for use on lines where a large number of sets are required. The secondary of the induction coil, in series with the condenser is permanently bridged across the line, so that the characteristics of the line do not materially change whether one or all of the stations are listening in at the same time. This also insulates the operator from the line as the telephone equipment is connected to the primary of the induction coil. The induction coil has a breakdown of approximately 1000 volts A.C. between the windings.

When the switch of the desk set box is closed to the transmitting position, the receiver is not cut out entirely, but is left across part of the coil so that the dispatcher can, in case of error, break in on an operator repeating an order.

In the No. 501A Set, the key for switching from listening to talking position is included in the box. The No. 501B Set is the same as the No. 501A, except that the key is omitted, the wiring being brought to terminals in the set so that a foot switch or separate key can be used.

RAILWAY TRAIN DISPATCHING TELEPHONE SYSTEMS

Way Station Equipment (Continued)

Protection of Way Station Equipment

The function of the protector is to protect the inside apparatus against damage from high voltages by providing a shunt path from each side of the line through an air gap between the blocks to a well established ground connection. It is important that this ground connection be well and permanently made. A fuse in each side of the line is also provided to guard the drop wires against abnormal currents. Seven ampere fuses are generally used.

The No. 58BP Protector connected between the 60B Selector Apparatus Case and the line wires consist of

- 1—No. 29B Protector Mounting—for Blocks
- 1—No. 16 Protector Mounting—for Fuses
- 1—No. 48 Protector Mounting—Asbestos Pad
- 2—No. 11C Fuses—7 ampere
- 2—No. 26 Protector Blocks—Hard Carbon
- 2—No. 30 Protector Blocks—Porcelain with carbon insert



No. 58BP Protector

The spacing between the blocks is such that a break down will occur on an average of 700 volts. Thus a low impedance path is provided to lead the high voltages off to ground rather than through the calling or telephone apparatus. Damage to the apparatus is thereby avoided.

The fuses should always be connected on the line side and the blocks on the station side.

Loud Speaking Telephone Equipment



No. 579A Loud Speaking Telephone

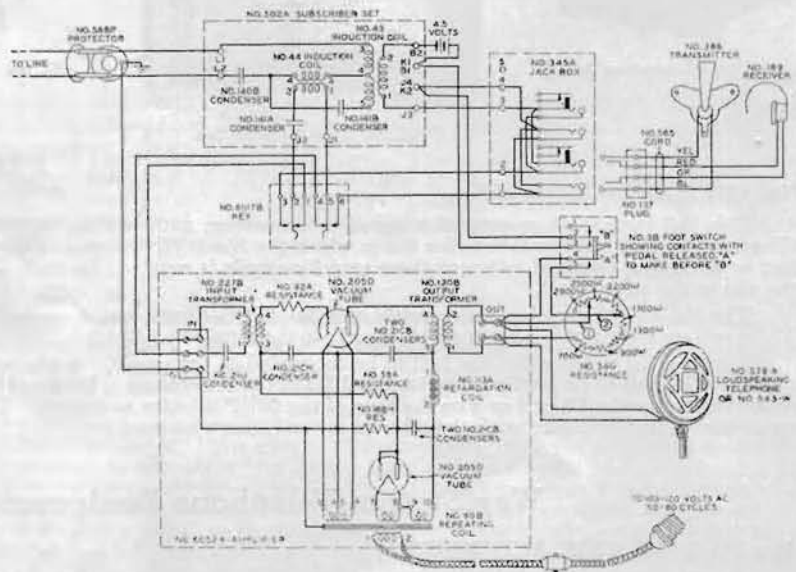

Schematic of Dispatcher's Loud Speaking Telephone Equipment

Dispatcher and Way Station

The loud speaking telephone amplifier is for use in Dispatcher's office, signal towers, and way stations to supplement the usual telephone outfit. It is designed to amplify the incoming conversation, so that the loud speaking telephone connected to it will produce sufficient volume to be heard at a distance of several feet, thus relieving the dispatcher or operator of the necessity of wearing a head set. The equipment is divided into two classes, that which is for use in dispatchers' offices and that which is for use at signal towers and way stations.

RAILWAY TRAIN DISPATCHING TELEPHONE SYSTEMS

Loud Speaking Telephone Equipment (Continued)

DISPATCHER'S EQUIPMENT

The following loud speaking telephone equipment may be used in the Dispatcher's Office:

D.C. CURRENT SUPPLY

- 1—No. 12A Loud Speaking Telephone Outfit
- 1—No. 345A Jack Box
- 1—No. 3B Foot Switch

A.C. CURRENT SUPPLY

- 1—No. 6052A Amplifier (for 60 cycle, 110 volt) or,
No. 6040A Amplifier (for 25 cycle, 110 volt).
- 1—No. 579A Loud Speaking Telephone.
- 1—No. 147AC Transmitter Arm.
- 1—No. 34G Resistance.
- 1—No. 3B Foot Switch.
- 1—No. 6017B Key.
- 1—No. 345A Jack Box.

WAY STATION EQUIPMENT

The following loud speaking telephone equipment may be used in Way Stations:

- 1—No. 6052A Amplifier (60 cycles, 110 volt) or,
No. 6040A Amplifier (25 cycles, 110 volt).
- 1—No. 579A Loud Speaking Telephone.
- 1—No. 147AC Transmitter Arm.
- 1—No. 3D Foot Switch with
- 1—No. 1A or B Foot Switch Attachment, and
- 1—No. 2A Foot Switch Attachment.

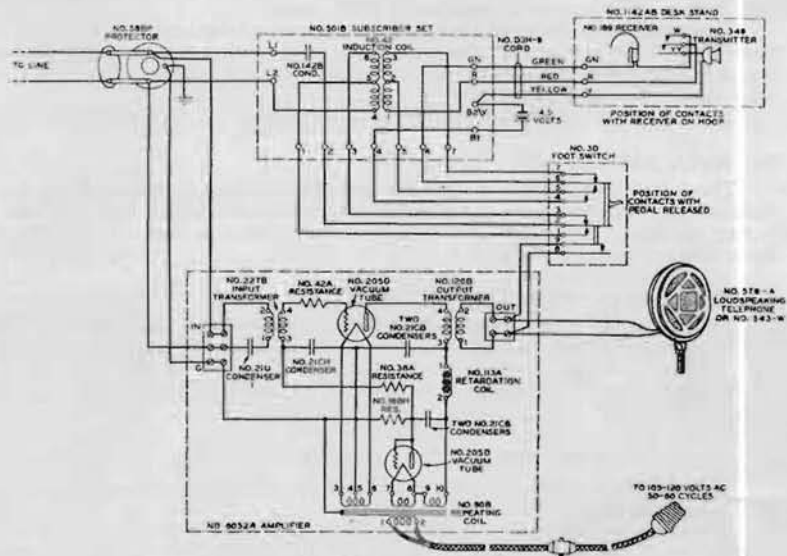

Schematic of Way Station Loud Speaking Telephone Equipment

No. 12A LOUD SPEAKING TELEPHONE OUTFIT

The No. 12A Loud Speaking Telephone outfit consists of a No. 519A Subscribers Set, a No. 216A Vacuum Tube, and a No. 543W Loud Speaking Telephone. This Outfit is designed for use at Dispatchers' Stations and is operated on a direct current power supply.

Note: A No. 579 Loud Speaking Telephone or a KS-6368 Horn with a No. 549 Receiver may be used in place of the No. 543W Receiver in this outfit.



No. 6040A Amplifier
No. 6052A Amplifier

No. 6052A AMPLIFIER

The No. 6052A Amplifier consists of a No. 52A Amplifier and two No. 205D Vacuum Tubes and may be used at either dispatcher or way stations. It is a single stage audio frequency amplifier with a self-contained current supply set operating from 110 volts 60 cycle AC supply. The power consumption is approximately 40 watts. No batteries are required for its operation.

RAILWAY TRAIN DISPATCHING TELEPHONE SYSTEMS

Dispatcher & Way Station Equipment (Continued)

The apparatus is contained in a rectangular metal box approximately 11" long, $9\frac{3}{16}$ " wide and $9\frac{3}{16}$ " high and is provided with a carrying handle. A cord switch and plug are provided for connecting to the 110 volt 60 cycle AC supply.

The amplification given by this amplifier is, in general, sufficient to give satisfactory loud speaking telephone operation where good volume is obtained from the head set and where the line and external noises are not excessive.

The input impedance of the amplifier is such that a relatively large number of amplifiers may be connected across the telephone line without introducing excessive losses which might interfere with conversations carried on between stations at extreme ends of the line. Also, in view of the possible use of the line for selector operation, the input impedance of the amplifier has been so arranged that it will not offer any considerable shunting effect to the selector currents.

When working from an impedance of 900 ohms, the gain of the amplifier is approximately 25 db at 1000 cycles. The output impedance is 4000 ohms.

The amplifier is designed for connecting across a telephone line where it will remain in operation at all times. When the operator desires to talk, the loud speaker may be made partially inoperative by means of a foot switch arranged to short circuit the output of the amplifier. The loud speaker and the foot switch are not a part of this amplifier.

The typical connection diagrams for this amplifier are shown on pages 18 and 19.

No. 6040A AMPLIFIER

The No. 6040A Amplifier used for train dispatching operates on 110 volt 25 cycle AC power supply circuits. It is otherwise the same electrically as the No. 6052A and may also be used at either dispatcher or way stations. It uses two No. 205D Vacuum Tubes as does the No. 6052A and is enclosed in a brown japan finished metal box about $11\frac{1}{2}$ " x 10" x $9\frac{1}{4}$ ".

No. 579A LOUD SPEAKING TELEPHONE

The No. 579A Loud Speaking Telephone consists of a No. 570A Loud Speaking Telephone mounted in a black finished cone shaped metal case approximately 10" in diameter and $4\frac{1}{2}$ " thick. It has a grilled front backed by a wire screen. Illustration page 18.

It is intended to mount on a No. 147AC Transmitter Arm and is arranged to take any cord equipped with No. 80 Cord Tips.

No. 543W LOUD SPEAKING TELEPHONE

The No. 543W Loud Speaking Telephone consists of a brass base similar to a desk stand base, equipped with a black finished fibre horn $20\frac{3}{8}$ " high.

The base is equipped with a felt cushion covering on the bottom, a hole is provided in the base for adjustment of the receiver unit. The No. 545 Receiver and the No. 762 Cord form parts of this loud speaking telephone.

No. 3B AND No. 3D FOOT SWITCHES

The No. 3B Foot Switch at the dispatcher's station and the No. 3D Foot Switch at the way station, are for use in disconnecting the transmitter from the line, and also changes the value of the shunting resistance across the output of the amplifier, as described below. The switch must be depressed to talk and released to receive, although at the dispatcher's station reception for "break in" purposes at a reduced volume may be had while the switch is depressed.

No. 34G RESISTANCE

The No. 34G Resistance at the dispatcher's station is for use in providing an adjustment for the loud speaker volume.

The connections to the No. 34G Resistance at the dispatcher's station are shown on page 18. The connections at "1" and "2" should be determined in the following manner:

With the power supply turned on, and the No. 6017B Key depressed, any talk on the line should be heard in the loud speaker, the volume of which can now be adjusted to a satisfactory level by placing connection No. 1 on a suitable tap. The proper tap will generally be one of the last two or three or it may be that the full output of the amplifier is required, in which case this connection may be left off altogether.

The proper tap for connection No. 2 should be chosen with the foot switch depressed and a distant operator talking. This connection determines the loud speaker "break in" level and also is intended to prevent howling, which is caused by feed back from the loud speaker into the transmitter. This howling ordinarily occurs when the transmitter is in circuit unless the loud speaker volume is held below a certain critical value. The value of resistance which gives a satisfactory "break in" efficiency will usually be less than that required to prevent howling.

No. 6017B KEY

The No. 6017B Key at the dispatcher's station is used for switching from the loud speaking telephone to the head set telephone and vice versa.

RAILWAY TRAIN DISPATCHING TELEPHONE SYSTEMS

Battery Requirements

The current supply for this system consists of a main DC battery of 150 to 400 volts and a local battery of 12 or 24 volts at the dispatchers' stations and a 4 volt battery at each way station.

The main battery furnishes the current for operating the selectors at the way stations. The voltage required depends on the loop resistance of the line wires and the location and number of selector sets on the line. For standard circuits using No. 160 type Selector Sets with condensers in the sets, the voltage required for normal operation can be determined from the voltage line selector curves shown on page 21, figure 1. For transformer or repeating coil circuits the voltage required for normal operation can be determined from the curves shown on page 22, figures 2 or 3. These curves show the voltage required for different length lines of No. 9 B. & S. copper wires—8.3 ohms per loop mile—equipped with selector sets uniformly distributed. The voltage specified for normal operation is higher than the minimum operating voltage required. This insures the operation of the selectors when the line insulation is low during wet weather and allows for a slight decrease in the potential for any reason. The potential should in no case be allowed to decrease more than 15%.

Dry cells, storage cells, a motor-generator set, or a Western Electric No. 60B Vacuum Tube Rectifier may be used for this main current source. When dry cells are used, frequent measurements should be made to determine the potential of the battery when the current is flowing under operating conditions. This is necessary because the gradual increase in internal resistance of the dry cells will lower the voltage available for operating the selectors.

No. 60B VACUUM TUBE RECTIFIER

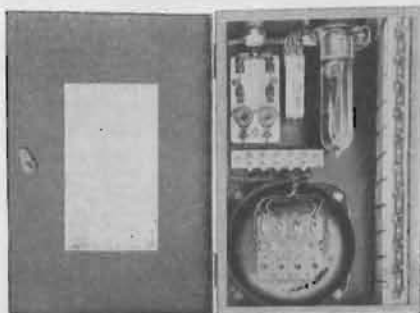

Open View

The No. 60B Vacuum Tube Rectifier is operated from a 110 volt, 60 cycle, alternating current source and may be used instead of dry cells, storage cells, or a motor-generator set, to furnish the main power for operating one or two selector circuits. It does away with the periodic tests of dry cells, the charging of storage cells or the continuous large power drain of the motor-generator sets.

The Rectifier consists of a fuse-and-switch block, No. 72A Repeating Coil, No. F-11 Relay, eleven No. 138B Condensers, Vacuum Tube Socket for mounting the Western Electric No. 214E Vacuum Tube, and a terminal block mounted in a black finished sheet steel box 18" high, 12" wide and 6½" deep. It weighs approximately 60 pounds.

The 110 volt, 60 cycle, alternating current is connected through the switch block and the fuse (6 amperes) to the primary of the repeating coil shown below. The secondary of the repeating coil is provided with taps (terminals S1-S6) for supplying alternating current of 60 to 540 volts potential in

60 volt steps to the plate circuit of the vacuum tube. To obtain these values the two flexible leads (black and green) to the No. 72A Repeating Coils should be connected to the following terminals:

S1 and S2 for 60 volts	S1 and S4 for 300 volts
S2 and S3 for 120 volts	S2 and S5 for 360 volts
S1 and S3 for 180 volts	S1 and S5 for 420 volts
S2 and S4 for 240 volts	S2 and S6 for 480 volts
S1 and S6 for 540 volts	

The steps permit of adjusting the DC output of the rectifier to the needs of the circuit as determined from the voltage-line selector curves shown elsewhere in this catalog. The direct current voltage output of the set equals the alternating current input to the tube with a small load on terminals B1 and B2 and decreases from 10 to 35 per cent in proportion with a larger selector load. Under maximum load conditions, the maximum direct current output is approximately 0.300 ampere at 400 volts potential.

The tertiary winding of the repeating coil supplies current at 10 volts potential for lighting the vacuum tube filament, through the contacts of the F-11 Relay. The condensers tend to hold up the voltage of the rectified current during the interval between the rectified half-waves.

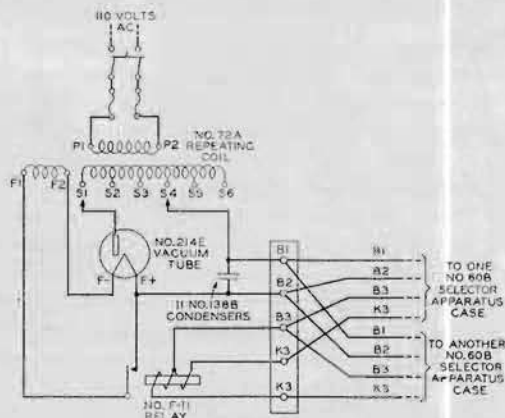

Schematic Diagram of No. 60B Vacuum Tube Rectifier

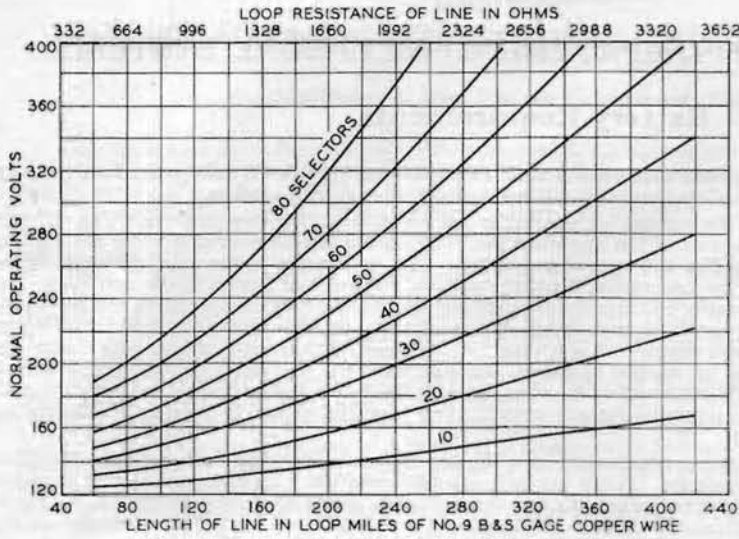

VOLTAGE
LINE SELECTOR
CURVES

Fig. 1
Voltage-Line Selector Curves
for No. 160 Type Selector Set

Fig. 2
Curves for No. 160 Type Selector Sets
Operated through a No. 341A Transformer

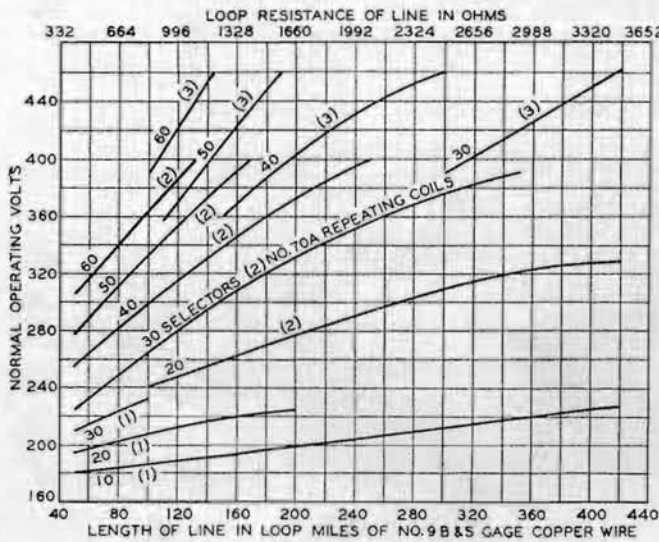
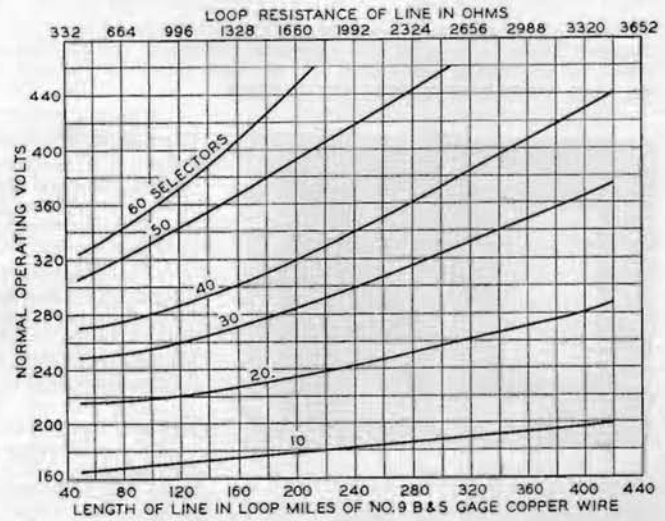

Fig. 3
Voltage-Line Selector Curves for No. 160
Type Selector Sets Operated through
No. 70A Repeating Coils

RAILWAY TRAIN DISPATCHING TELEPHONE SYSTEMS

Vacuum Tube Rectifier—Battery Requirements (Continued)

The terminal block has five terminals for outside connection as follows: B1, B2 and B3 to be connected to B1, B2, B3 of one or two No. 60B Selector Apparatus Cases. One K3 to be connected to the K3 terminal of one No. 60B Selector Apparatus Case and a second K3 to be connected to the K3 terminal of the second No. 60B Selector Apparatus Case when used.

When using the No. 60B Rectifier as the line battery supply, and operating the selectors through a transformer the No. 221JB Relay in the No. 60B Selector Apparatus Case is not required and its line contacts should be closed permanently. Also the lead to terminal K3 in the No. 60B Selector Apparatus Case should not be connected. This allows the condensers in the rectifier to become discharged at the end of a call and thus prevent the possibility of two preliminary pulses through the selectors on the next call.

The filament of the vacuum tube lights only when the No. F-11 Relay is energized as a selector key is operated to make a call. The filament circuit is closed a second before calling impulses are sent out. This allows the filament to heat sufficiently to rectify a full potential impulse at the start. The average life of the No. 214E Vacuum Tube based on 200 to 300 calls per day, is approximately two years but this figure is not guaranteed. This life is with a filament current of 3.2 amperes. If the current is increased the life of the tube is shortened.

The set rectifies only when the filament of the tube is lighted. This decreases the drain on the alternating current source and lengthens the life of the tube. The drain during non-calling periods when the filament circuit is open is 8 watts and on the average selector circuit the drain is approximately 90 watts while calling. At the rate of 300 calls per day (8 seconds per call) the rectifier would require 250 watt-hours per day.

The No. F-11 Relay in the filament circuit is provided with two windings so that it may be operated by the selector keys of two selector circuits separately or at the same time.

LOCAL BATTERY

The local battery at the dispatcher's station furnishes current for operating the No. 26A and No. 221JB Relays. Dry cells or sufficient storage cells to give a voltage of 12 or 24 volts should be used. In no case should the voltage of this battery be allowed to decrease to less than 8 volts.

WAY STATION BATTERY

The way station battery furnishes current for operating the No. 60CG Ringer. It may consist of primary or secondary cells. The voltage of this battery should be from 3 to 5 volts. The transmitter battery of the way station telephone sets may be used as a common battery for the telephone transmitter and for the ringer of one or two selector sets.

Operation of Selector Circuits through Transformers and Repeating Coils

No. 70A Repeating Coil



No. 341A Transformer

In many cases it is of advantage to operate train and message circuits with No. 60 type Selectors through transformers or repeating coils to:

- (1) Obtain a low resistance in the simplex telegraph leg.
- (2) Operate two or more simplex selector circuits from the common battery supply.
- (3) Operate one or more branch selector circuits from the main selector circuit without any metallic connection to it.
- (4) Allow two selector circuits to be used as side circuits for obtaining a composited or simplex phantom with the physical and phantom telephone and the telegraph circuits terminated at the same or different points.

RAILWAY TRAIN DISPATCHING TELEPHONE SYSTEMS

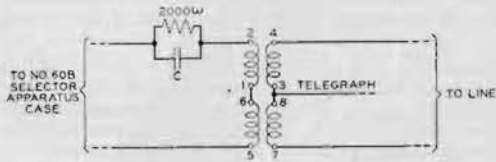
Operation of Selector Circuits Through Transformers and Repeating Coils (Continued)

Schematic of the Selector Circuit Operated through No. 341A Transformer

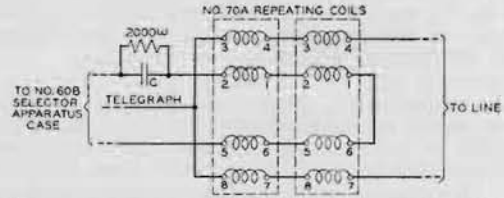

Schematic of the Selector Circuit Operated through Two No. 70A Repeating Coils in Series Aiding

No. 341A TRANSFORMER

The No. 341A Transformer has a shell type silicon steel core clamped between angle iron brackets which also provide a mounting for the transformer and for the terminal connecting block. The transformer is approximately 6" long x 5 $\frac{3}{8}$ " wide x 5 $\frac{3}{4}$ " deep, and weighs approximately 20 pounds. It has four windings brought out to separate terminals. The primary windings (1-2 and 5-6) each have a resistance of approximately 90 ohms and the two secondary windings each have a resistance of approximately 175 ohms. The primary windings and the secondary windings are each balanced from a resistance, inductance and capacity standpoint to within 200 crosstalk units to permit the coil to be used on simplex telephone circuits arranged for duplex telegraph without interference from the telegraph on the side or phantom telephone circuits.

The transformer is especially designed for repeating the low frequency (3 $\frac{1}{2}$ cycles) selector impulses for long lines with a large number of selectors. The impedance at 900 cycles of the two secondary windings connected in series aiding is approximately 6,000 ohms, and of the two primary windings in series aiding is approximately 12,000 ohms. The loss of bridging the transformer on a line as a simplex bridge is, therefore, very small.

The loss in telephone transmission due to inserting a No. 341A Transformer in the center of a long line of No. 9 B. & S. gauge non-loaded open copper wire is approximately 5 decibels.

No. 70A REPEATING COIL

The No. 70A Repeating Coil is a toroidal type coil mounted on a wood base. The complete coil is approximately 8 $\frac{1}{2}$ " wide x 11" deep x 5" high, and weighs approximately 26 pounds.

The coil has four windings brought out to separate terminals. The two secondary windings (3-4 and 7-8) each have a resistance of approximately 40 ohms, and the two primary windings (1-2 and 5-6) each have a resistance of approximately 45 ohms. The primary windings and the secondary windings are balanced from a resistance, inductance and capacity standpoint to within 200 crosstalk units to permit the coil to be used on simplex telephone circuits arranged for duplex telegraph without interference from the telegraph.

The No. 70A Repeating Coil is also designed for repeating the low frequency (3 $\frac{1}{2}$ cycles) selector impulses and for telephone transmission frequencies. The loss in telephone transmission due to inserting a No. 70A Repeating Coil in the center of a long line of No. 9 B. & S. gauge non-loaded open copper wire is approximately 1 $\frac{1}{4}$ decibels. The impedance at 900 cycles of either the two primary or the two secondary windings of the coil connected in series aiding is approximately 8000 ohms. The loss due to bridging the coil on the telephone line as a simplex bridge is, therefore, very small.

TRANSFORMER AT DISPATCHER'S STATION

When the entire selector circuit is to be operated through a transformer, the No. 341A Transformer should be used and the connections should be as shown above. The telephone set should be connected to the line side of the transformer.

If it is desirable to talk through the transformer at the dispatcher's station and keep the transmission loss to a minimum, the No. 70A Repeating Coil may be used, connected as shown above.

RAILWAY TRAIN DISPATCHING TELEPHONE SYSTEMS

Operation of Selector Circuits Through Transformers and Repeating Coils (Continued)

The capacity of the condenser shown at "C" in each case should be not less than 10 mf plus 1 mf for each selector on the circuit. A resistance of 2000 ohms (Ward-Leonard DM-2000) should be connected in parallel with the condensers to prevent oscillatory discharges of the condensers from interfering with the operation of the selectors.

When a No. 60B Rectifier is used as the battery supply with the circuit connections shown on page 24, the contacts of the 221JB Relay in the No. 60B Selector Apparatus Case should be closed permanently and the lead to terminal K3 not connected. This allows the condensers in the rectifier set to become discharged at the end of a call and thus prevent two preliminary pulses through the selectors on the next call.

A No. 160B Condenser has been especially designed for use for the condenser at "C".

The No. 160B Condenser is a black metal box approximately 7½" long x 6" wide x 5" deep, equipped with 16 No. 138B Condensers connected in parallel giving a normal capacity of 20 mf. As many of these condenser units connected in parallel should be used as required to give the total capacity required at "C".

The voltage of the main battery required is somewhat greater when operating through a transformer than shown on page 22, Fig. 1, for a standard circuit. The curves, page 22, Fig. 2, show the normal voltage required when using the No. 341A Transformer with different length lines of No. 9 B. & S. copper wires, 8.3 ohms per loop mile, and with selector sets uniformly distributed. Similarly, the curves, page 22, Fig. 3, show the normal voltage required when using one No. 70A Repeating Coil and when using two or three coils connected in series aiding as required.

It will be seen from the illustrations, page 22, Figs. 2 and 3, that the No. 341A Transformer is considerably more efficient than the No. 70A Repeating Coil in repeating the selector impulses to the lines. Even with very long lines only one coil will be required while with the No. 70A Coil two or three coils will be required.

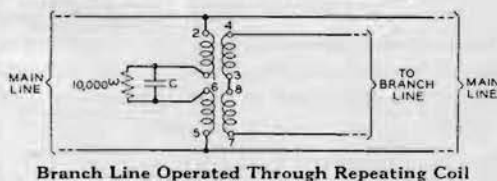
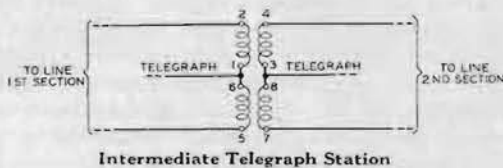

No. 160B Condenser

INTERMEDIATE SIMPLEX TELEGRAPH STATION

When an intermediate simplex telegraph station is required, either the No. 341A Transformer or the No. 70A Repeating Coil may be connected in the line circuit as shown above, and the main selector line at the dispatcher's station should be operated through a No. 341A Transformer as shown on page 24. As stated above, the No. 341A Transformer is more efficient for transmitting the selector impulses, while on the other hand it will cause more transmission loss than one or two No. 70A Repeating Coils.

BRANCH LINE

When a branch circuit is required without any metallic connection to the main line and when the main line is not operated through a transformer, it should be connected as shown above. The capacity of the condenser at "C" should be not less than 10 mf plus 1 mf for each selector on the branch line. When the main line is operated through a transformer as shown on page 24 the primary of the No. 341A Transformer or the No. 70A Repeating Coil should be connected directly to the main line without any condensers or resistances in series. In this case, also, the No. 341A Transformer is more efficient for transmitting the selector impulses and not quite as good from the telephone transmission standpoint.

RAILWAY TRAIN DISPATCHING TELEPHONE SYSTEMS

*Operation of Selector Circuits Through Transformers and Repeating Coils (Continued)***SIMPLEX BRIDGE**

For a simplex bridge at the far end of a train or message line operated through a transformer, a No. 70A Repeating Coil or a No. 341A Transformer should be connected as shown at the far end of each side circuit, note composite phantom circuit below.

When the selector circuit is not operated through a transformer at the dispatcher's station, a No. 34C Resistance connected to give 1000 to 2000 ohms should be connected between each side of the simplex coil and the line wires at both the near and far end of the line.

COMPOSITED PHANTOM

A general arrangement for using a train and message line for side circuits of a composited phantom, to give two simplex telegraph circuits and a through telephone circuit in addition to the two selector circuits is shown below.

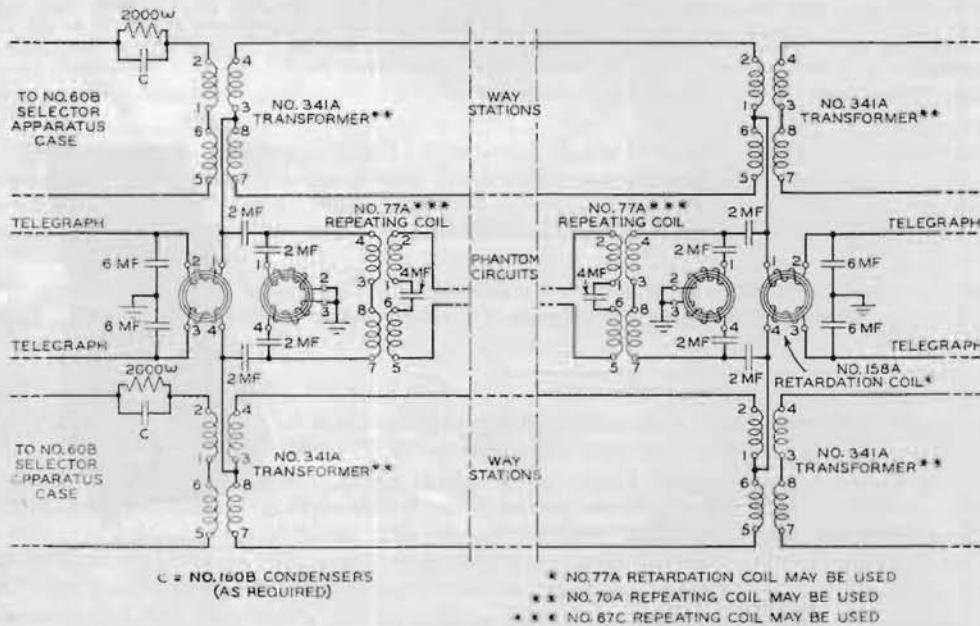

Composite Phantom Circuit

RAILWAY TRAIN DISPATCHING TELEPHONE SYSTEMS

Portable and Siding Telephone Sets

GENERAL

Portable and Siding telephone sets are intended for use of conductors and trainmen for calling dispatchers from various points on the railway train dispatching telephone system. The circuits of these sets are arranged similar to the telephone circuits of way stations. The sets are usually equipped with push-buttons for use when talking. Described in detail under "Telephone Sets."



No. 1330 Telephone Set

SIDING TELEPHONE SETS

Siding telephone sets are wall type sets usually employing a head set receiver and equipped with or without a ringer or hand generator, depending upon whether one or two-way ringing service is required over the system.

PORTABLE TELEPHONE SETS

Portable telephone sets are for use of conductors and trainmen for calling the dispatcher from any point on the train dispatching system. These sets are equipped with hand set telephones. Line connections to the sets are usually made by means of line-poles which are furnished separately.

Testing Equipment

No. 60B TEST SET

The No. 60B Test Set is a small portable set suitable for testing selectors or selector sets for their electrical operation. The set consists of a relay for reversing the current through the selector, a potentiometer for varying the current through the selector, three small keys to give test conditions, a meter and a condenser, all mounted on a removable panel in a black finished sheet steel box $8\frac{1}{8}$ " long, $7\frac{1}{4}$ " wide, and $5\frac{3}{4}$ " deep. The box is equipped with a carrying handle.

The panel is arranged to mount a No. 60 type Selector Key for operating the selector under test and there is space in the bottom of the box for mounting three No. 768 Eveready batteries to be connected in series and to the B1 and B2 terminals. The complete set including batteries weighs 14 pounds.

The schematic circuit of the No. 60B Test Set is shown below.

Other test sets for various purposes can be furnished, depending upon the requirements. Refer to description of "Apparatus."

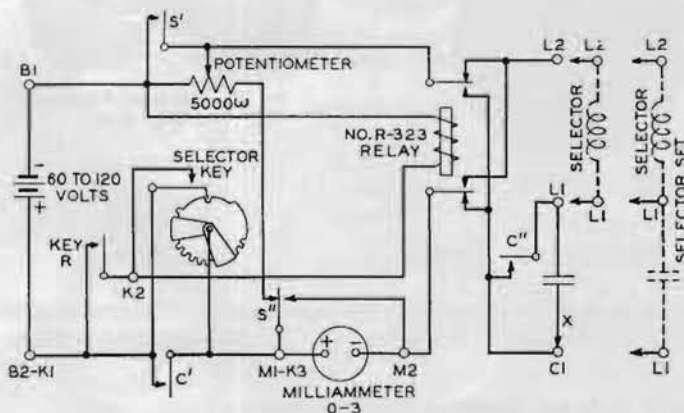

NOTE:— KEY S CONSISTS OF S' AND S''
KEY C CONSISTS OF C' AND C''

Schematic of No. 60B Test Set



No. 60B Test Set

RAILWAY TRAIN DISPATCHING TELEPHONE SYSTEMS

CHAPTER III

DESCRIPTION OF APPARATUS

BATTERY BOXES



No. 1A Battery Box

The Nos. 1 and 2 Type Battery Boxes provide a neat and convenient means of mounting dry cells and protecting them from injury. They are made of sheet metal, finished with black japan and are lined with insulating material. Pear-shaped mounting slots are provided to facilitate mounting the boxes on vertical surfaces, and for readily removing them. This permits of their being located at the sides of or under desks, and in other places where they will be out of the way and yet be accessible and adjacent to the telephone or apparatus to which they are connected.

Code No.	Dry Cell Capacity	Dimensions Ins.
1A	3 No. 6 cells	$3\frac{1}{4} \times 7\frac{1}{32} \times 9\frac{7}{16}$
2A	4 No. 6 cells	$3\frac{1}{4} \times 7\frac{3}{8} \times 12\frac{3}{4} - 3\frac{7}{32} \times 7\frac{3}{8} \times 12\frac{19}{64}$
2B	9 No. 6 cells	$5\frac{23}{32} \times 7\frac{7}{16} \times 14\frac{1}{32}$

BELLS



No. 127 Type

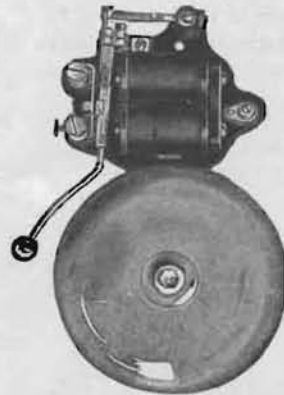

No. 101402 Bell



No. 392 Type Loud Ringing Extension Bell

Extension Type

These extension bells consist of a ringer mounted in an oak box with exposed gongs. The approximate overall dimensions are $6\frac{1}{2}$ inches wide by $5\frac{7}{8}$ inches high by $4\frac{7}{8}$ inches deep. The standard finish is golden oak.

The Nos. 127 E, F and G Extension Bells will operate on telephone ringing current.

The No. 127H Extension Bell has a split wound ringer for use on simplex circuits. This ringer also performs the function of a split retardation coil for such services.

RAILWAY TRAIN DISPATCHING TELEPHONE SYSTEMS

Bells (Continued)

The No. 127J Extension Bell contains a direct current type of ringer to operate from one or two dry cells for use in connection with selector apparatus equipment.

If different tone gongs are required, the extension bells should be ordered in accordance with D specifications as shown below opposite the code number listings. For example, if the No. 127E Extension Bell is required equipped with a No. 3 cow gong, order as follows: No. 127E Extension Bell D-5979.

Code No.	Ringer No.	Resistance Ohms	Gong No.	Special Gongs (See note above)		
				No. 21 Sleigh Gong	No. 3 Cow Gong	No. 10 Ten Gong
127E Ext. Bell	38AG	1020	26A	D-25816	D-5979	D-19344
127F Ext. Bell	38BG	2500	26A	D-5980	D-7000	D-7009
127G Ext. Bell	38FG	1620	26A
127H Ext. Bell	43NG	88	26A
127J Ext. Bell	60CG	26A-(Equipped with a No. 21BA Condenser)			

BELLS—LOUD RINGING EXTENSION TYPES

These bells are equipped with galvanized gongs and with a black finished metal base. The cover is moisture proofed.

Code No.	Resistance	Gong No.	Diameter of Gongs
392A Subscriber Set	1000 ohms	28A	6 inch
392B Subscriber Set	2500 ohms	28A	6 inch
392E Subscriber Set	1600 ohms	28A	6 inch

BELLS—LOUD RINGING EXTENSION TYPES—WITH BACKBOARD

Code No.	Ext. Bell No.	Resistance	Backboard No.
342J Sub. Set	No. 392A Sub. Set	1000 ohms	152A (replaces 149A)
342K Sub. Set	No. 392B Sub. Set	2500 ohms	152A (replaces 149A)

BELLS—VIBRATING TYPES

These are loud ringing vibrating bells for operation on direct current. The No. 101403 Bell differs from the No. 101402 Type in that it is equipped with an armature contact for operating a drop.

List No.	Resistance Ohms	Diameter of Gong	Used with Selector Sets
101402	1100	4 in.	No. 101A, No. 101B
101403	1100	4 in.	No. 101A, No. 101B
101404	5.3	4 in.	No. 102A, No. 102B

RAILWAY TRAIN DISPATCHING TELEPHONE SYSTEMS

BINDING POSTS

For Telephones



Code No.	Description	Finish
1A	Thumbscrew connections, no soldering terminals.	Brass
2A	Lock nut connections, one back soldering terminal.	Nickel
2C	Similar to No. 2A but with wing nut instead of lock nuts.	Nickel
2E	Lock nut connections, one front soldering terminal.	Brass
3A	Lock nut connections, one back soldering terminal.	Nickel
3B	Wing nut connection; used in 1314A Telephone Set. Screw Mounting.	Nickel
3C	Wing nut connections; one back soldering terminal; used on the No. 1017 Test Set. Screw Mounting.	Nickel
16A	To take one tubular tip.	Nickel
20A	Screw connections, one front soldering terminal.	Nickel
29A	Used in No. 8 and No. 14 Cable Terminals when the original binding posts break off above the lower nut. For 10-32 thread only.	Tinned
30A	Screw connection, one soldering terminal.	Tinned
33D	Insulated Binding Post, arranged to mount on $\frac{1}{2}$ " panel.	Black
37A	Line Type for miscellaneous uses.	Brass
44A	Wing nut connections, one front soldering terminal.	Nickel
P-121382	Line Type for miscellaneous uses.	Tinned
9	Cord fastener, Line Type for miscellaneous uses.	Tinned

TERMINAL PUNCHINGS

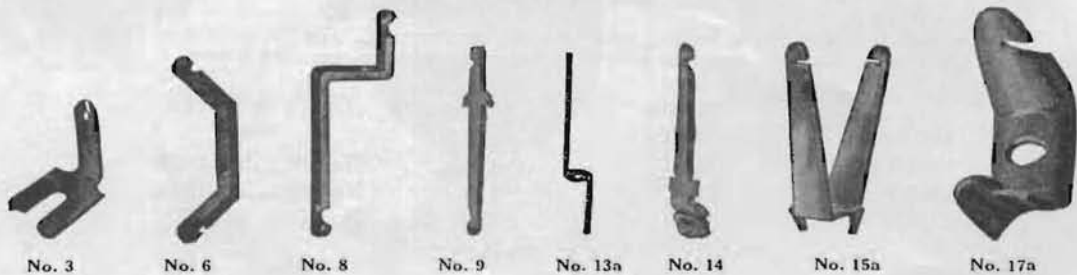

Code No.	Material	Use
3	Nickel, silver	On fuse posts and fuse blocks
6	Brass, tinned ends	For the ground side of ringing leads
8	Brass, tinned ends	On double sided connecting racks
9	Brass, tinned ends	On No. 10 switchboards
13A	Brass, dip tin finish	On double sided connecting racks
13B	Brass, dip tin finish	Similar to No. 13A, except $\frac{1}{2}$ " shorter
14	Brass, one end tinned	For screw connection on one end
15A	Brass, tinned ends	On one sided connecting racks
17A	Brass, tinned ends	On induction coils and telephone coils
21A	Brass, dip tin finish	On repeating coils, induction coils, and retardation coil

RAILWAY TRAIN DISPATCHING TELEPHONE SYSTEMS CABLES AND CABLE TERMINALS



Cable for Interior Use

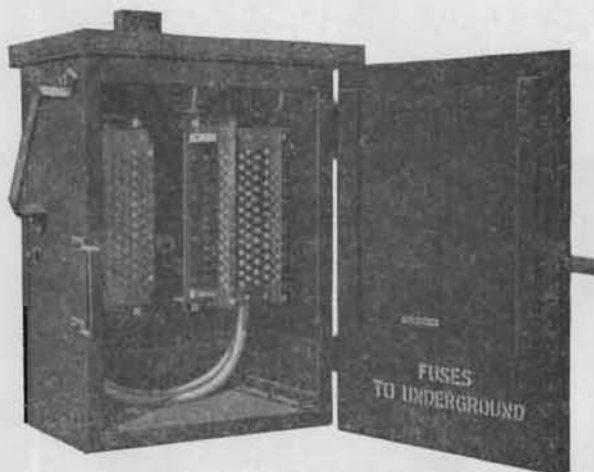

B26 Cable Terminal



Lead Covered Cable

CABLES (INTERIOR) FOR WAY STATIONS

The following list of interior way station cables have tinned black enameled single silk served and cotton braided conductors and waxed cores and are covered with a cotton braid which is impregnated with fire proofing paint.

Code No.	No. of Conductors	B. & S. Gauge	Diameter
1450	6	No. 20	19/64"
1451	12	No. 20	25/64"
1453	22	No. 20	31/64"

Note: For a general line of textile insulated cables see Telephone Apparatus and Cable Catalog.

CABLES—LEAD COVERED AND SUBMARINE

Lead covered cables for aerial and underground use, also for submarine purposes are available. For further information refer to detailed description of these cables in Telephone Apparatus and Cable Catalog.

EMERGENCY CABLES—"CIRCULAR LOOM"

These are emergency cables adapted for use in case of breaks in the telephone lines. The cables can be strung on poles, laid on the ground or through water and are easily handled as they are furnished on reels which are provided with stands for unwinding. These circular loom cables are furnished with No. 19 B. & S. gauge and No. 14 B. & S. gauge solid copper wire as follows:

Description	Size	Lengths
CL Emergency Cable	7 quads	1000 foot
	19 quads	500 foot
CL Bridle Cable	3 quads	As desired
	5 quads	As desired

TYPE "B" CABLE TERMINALS

The B26 Cable Terminal will terminate both a 26 pair underground cable and a 26 pair aerial cable and provides for cross connection. The other sizes have similar capacity ratings.

Code No.	Capacity Pairs	Cable Terminal Box No.	Includes
B26	26	B26	Equipped with
B51	51	B51	1 B26A Fuse Chamber and 1 B26A Binding Post Chamber
B76	76	B76	1 B51A Fuse Chamber and 1 B51A Binding Post Chamber
B101	101	B101	1 B76A Fuse Chamber and 1 B76A Binding Post Chamber
B152	152	B152	1 B101A Fuse Chamber and 1 B101A Binding Post Chamber
B202	202	B202	2 B76B Fuse Chambers and 2 B76B Binding Post Chambers
B304	304	B304	2 B101B Fuse Chambers and 2 B101B Binding Post Chambers
B404	404	B404	2 B76B Fuse Chambers and 2 B76B Binding Post Chambers 2 B76C Fuse Chambers and 2 B76C Binding Post Chambers 2 B101B Fuse Chambers and 2 B101B Binding Post Chambers 2 B101C Fuse Chambers and 2 B101C Binding Post Chambers

Note: B Fuse Chambers do not include the No. 7T Fuses which must be ordered separately.

RAILWAY TRAIN DISPATCHING TELEPHONE SYSTEMS

Cable Terminals (Continued)



No. 18E Cable Terminal, Open



Closed No. 14C Cable Terminal



Open

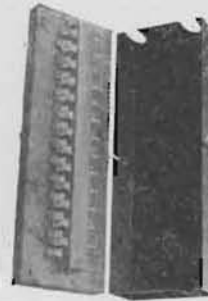

No. 12A Cable Terminal



Type C Cable Terminal Cover Removed

TYPE "BB" CABLE TERMINALS

This type Cable Terminal was designed for use in cross-connecting long sections of aerial cable or at points where aerial cables branch. A splicing chamber is provided at the bottom of the box for housing splices.

Code No.	Capacity Pairs	Cable Terminal Box No.	Includes Binding Post Chambers	
			Left Side	Right Side
BB26	26	BB26	1-B26A	1-BB26A
BB51	51	BB51	1-B51A	1-BB51A
BB76	76	BB76	1-B76A	1-BB76A
BB101	101	BB101	1-B101A	1-BB101A
BB152	152	BB152	2-B76B	2-BB76B
BB202	202	BB202	2-B101B	2-BB101B
BB304	304	BB304	2-B76C	2-BB76C
			2-B101B	2-BB101B
BB404	404	BB404	2-B76C	2-BB76C
			2-B101C	2-BB101C

TYPE "C" CABLE TERMINALS

The "C" Type Cable Terminal was designed for terminating lead covered cables and is provided with a cable stub which is attached to a terminal plate and sealed with compound. It is equipped with a cast iron mounting bracket arranged to mount with four screws.

Code No.	Capacity Pairs	Standard Length of Stub	Dimensions in Inches	Replaces
C10	10	6 1/2 ft.	4 1/4 x 5 5/16 x 12 3/4	8A
C16	16	6 1/2 ft.	4 1/4 x 5 5/16 x 14 3/4	*8B and 8D
C26	26	7 ft.	4 7/16 x 5 11/16 x 17 3/4	**8C and 8E

*Note: Two C16 Cable Terminals replace one No. 8D.
 **Note: Two C26 Cable Terminals replace one No. 8E.

No. 14 TYPE CABLE TERMINAL (Unprotected)

This terminal consists of a cast iron box with hinged cover, containing a porcelain terminal block with binding post for line connection. The back of the box is designed to permit mounting it on either a flat surface or a pole, by means of four screws.

The cover is arranged for charting the pairs on the inner surface.

This cable terminal can be ordered equipped with a 5 1/2, 8, 10 or 12 ft. cable stub, as required. This stub will enter from the top, unless otherwise specified.

Code No.	Capacity Pairs	Length Including Nipples	Width of Cover Inches
14B	11	10 3/16	7 1/2
14C	16	12 2 1/16	9 15/16
14D	26	17 2 3/16	14 1/2

No. 18 TYPE CABLE TERMINALS (with Protectors)

This is a protected terminal for open wire distribution from underground or aerial cable. It is enclosed in a round black finished iron cover approximately 8 9/16 inches in diameter. The cover is equipped with a spring to hold it when raised to the top of the terminal and a safety chain fastening it to the base. The base is slotted at the back making the terminal suitable for either wall or pole mounting. Both cover and base are galvanized.

Terminals are equipped with:

- No. 7A Fuses (7 ampere unless otherwise specified)
- No. 1 Protector Blocks
- No. 2 Protector Blocks
- No. 3 Protector Micas

RAILWAY TRAIN DISPATCHING TELEPHONE SYSTEMS

Cable Terminals (Continued)

A six-foot No. 22 B. & S. gauge cable stub is standard, and will be furnished attached to assembled terminal unless otherwise ordered.

Code No.	Capacity Pairs	Length, Inches	Code No.	Capacity Pairs	Length, Inches
18A	10	19 $\frac{3}{32}$	18D	30	33 $\frac{1}{16}$
18B	15	22 $\frac{1}{32}$	18E	50	46 $\frac{3}{32}$
18C	25	28 $\frac{3}{32}$	18F	60	53 $\frac{1}{32}$

No. 12 TYPE CABLE TERMINALS (Unprotected)

The No. 12 Type Cable Terminal is for interior distribution, and consists of a wooden base and a black finished metal cover. They are equipped with terminals having soldering connections at one end and screw connections at the other. Cable forms may be brought in from either end.

Code No.	Capacity Pairs	Dimensions, Inches		
		Length	Width	Depth
12A	13	11 $\frac{13}{16}$	4 $\frac{1}{16}$	1 $\frac{13}{16}$
12B	23	11 $\frac{13}{16}$	4 $\frac{1}{16}$	2 $\frac{13}{16}$
12C	33	11 $\frac{13}{16}$	4 $\frac{1}{16}$	3 $\frac{13}{16}$

NO. 2B CIRCUIT BREAKER

The No. 2B Circuit Breaker is an overload circuit breaker, designed for use in the main battery circuit of train dispatching lines to protect the relays and associated apparatus from excess currents, due to short circuits. It consists of a coil, armature and circuit breaker arm mounted on a black phenol fibre base, the overall dimensions being approximately 3 $\frac{3}{4}$ " x 6", and extending out from the wall approximately 4", when the arm is in the open or operating position. The resistance of the circuit breaker is 2 ohms and it is normally adjusted to operate on 0.6 ampere and not to operate on 0.4 ampere. These values can be increased or decreased by adjusting the air gap between the armature and the magnet by means of a knurled nut at the extreme end of the magnet. The best setting for the circuit breaker will depend somewhat on the local conditions for each installation.

The No. 2B Circuit Breaker is similar to the No. 2A Circuit Breaker formerly furnished except that it has a black phenol fibre base instead of a slate base, coin silver contacts instead of platinum contacts, and is equipped with alarm contacts.

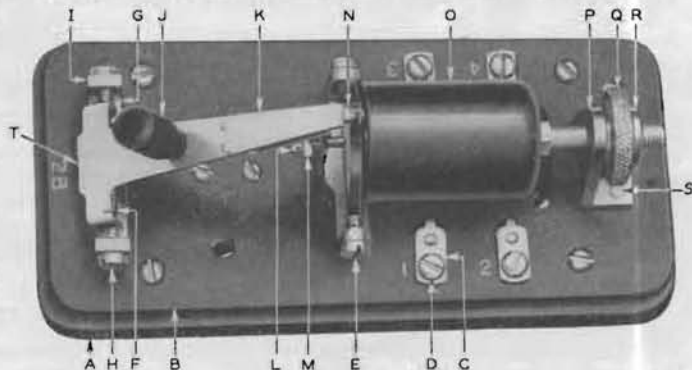

No. 2B Circuit Breaker

Replacement Parts

Letter	Subject	2B Circuit Breaker	Letter	Subject	2B Circuit Breaker
A	Sub-base	P-95346	N	Armature	* P-95326
B	Base	P-227865	O	Coil	P-95327
C	Binding Post	P-229128	P	Adjusting Bracket	P-95316
D	Screw	P-228895	Q	Adjusting Nut	P-95330
E	Trunnion Screw	P-95320	R	Tension Bracket	P-95333
F	Helical Spring	P-95336	S	Bracket Screw	P-95331
G	Screw	P-95337	T	Alarm Stud	P-95332
H	Pivot Screw	P-95335			P-227868
I	Trunnion Bracket	P-95334			
J	Handle	P-132717			
		* P-227367			
K	Arm	P-95338		Spring Pileup	
		P-95339		Screw	P-139931
		P-95340		Insulator	P-133451
L	Adjusting Screw	P-95321		Clamping Plate	P-107040
M	Adjusting Nut	P-95322		Bushing	P-13549
				Upper Contact Spring	P-166669
				Lower Contact Spring	P-143240

*To be assembled.

RAILWAY TRAIN DISPATCHING TELEPHONE SYSTEMS
CONDENSERS

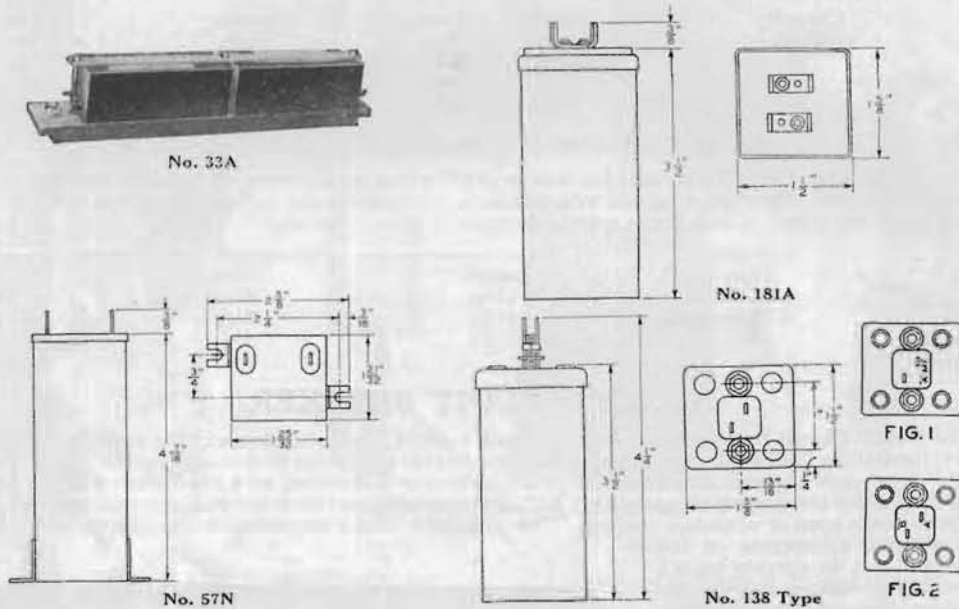

CONDENSERS—UNMOUNTED TYPE

Code No.	Rated Capacity Microfarads	Tested On Voltage	Use	Code No.	Rated Capacity Microfarads	Tested On Voltage	Use
31A	{0.05 0.05}	500 D.C.	General	181A	1 {Min. .85 Max. 1.15}	2000 D.C.	Railway (Replaces 21CB)

CONDENSERS—MOUNTED TYPE

The following condensers are composed of standard units mounted upon wooden bases as illustrated. The No. 33 Type mounts on a coil rack. These condensers are tested to 500 volts, direct current, except Nos. 33BJ and 33BS, which are tested to 1000 volts alternating current.

Code No.	Condensers Used	Rated Capacity Each	Overall Dimensions (Inches)	Code No.	Condensers Used	Rated Capacity Each	Overall Dimensions (Inches)
33A	2 No. 21L	2 (ea.)	10 3/4 x 1 7/8 x 2 3/8	33G	2 No. 21AD	{1.0 1.0} (ea.)	10 3/4 x 1 7/8 x 2 3/8
33B	1 No. 21L	2	10 3/4 x 1 7/8 x 2 3/8	33H	4 No. 21L	2 (ea.)	10 3/4 x 1 7/8 x 4 1/8
33C	2 No. 21BW	1 (ea.)	10 3/4 x 1 7/8 x 1 11/16	33L	2 No. 21AS	0.5 (ea.)	10 3/4 x 1 7/8 x 1 5/16
33D	1 No. 21BW	1	10 3/4 x 1 7/8 x 1 11/16	128BA	{1 No. 138A 1 No. 27B Bracket}	1 {Min. 1.00 Max. 1.25}	6 7/8 x 1 7/8 x 2
33E	2 No. 21N	0.5 & 1.0 (ea.)	10 3/4 x 1 7/8 x 1 5/8				
33F	1 No. 21AS	0.5	10 3/4 x 1 7/8 x 1 5/8				

The overall dimensions of the mounted condensers listed below are the same as those given for the No. 33E Condenser. Each condenser is wired to two separate terminals on one end of the base.

Code No.	Condensers Used	Capacity—M.F. Each Unit		Code No.	Condensers Used	Capacity—M.F. Each Unit	
		Minimum	Maximum			Minimum	Maximum
*33BJ	2 No. 138QA 2 No. 27B Brackets	1.07	1.09	33QD	2 No. 21QD	2.10	2.14
**33BS	4 No. 138QA 2 No. 27C Brackets	1.07	1.09	33QE	2 No. 21QE	2.12	2.16

*Replaces No. 33J Condenser. +27473
**Replaces Nos. 33S and 33T Condensers.

RAILWAY TRAIN DISPATCHING TELEPHONE SYSTEMS

Condensers (Continued)—Mounting Plate Type

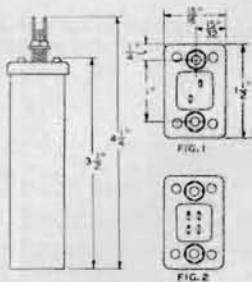

No. 139 Type

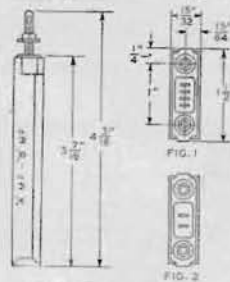

Nos. 141 & 142 Type



No. 160B Condenser

The following condensers are for use on relay type mounting plates:

The No. 138 Type Condensers require No. 24 Type Brackets when mounted in place of the No. 57 Type Condensers, and No. 27A Brackets when mounted in place of the No. 21AA Condenser. Furnished with two nuts and washers for mounting. Arranged to mount on 1 3/4" vertical and horizontal centers on mounting plates. Safe continuously applied voltage either DC or effective AC at 60 cycles or less and of an approximate sine wave, is 300 volts.

The No. 139 Type Condensers require No. 24 Type Brackets when mounted in place of No. 57 or similar Type Condensers. Furnished with two nuts and washers for mounting. Arranged to mount on 1" horizontal and 1 3/4" vertical centers. Safe continuously applied voltage, 200 DC or 180 effective AC at 60 cycles or less and of an approximate sine wave.

The No. 141 Type Condensers require No. 24 Type Brackets when mounted in place of No. 57 or similar Type Condensers. Arranged to mount on 1/2" horizontal and 1 3/4" vertical centers. Furnished with two nuts and washers for mounting. Safe continuously applied voltage 200 DC or 180 effective AC at 60 cycles or less and of an approximate sine wave.

If the No. 141H Condenser must fill the space of the No. 21 Type Condensers, order should specify P-409556 Adapter.

If the No. 141QF Condenser must mount in the same position as the No. 21AM Condenser, order should specify two P-127145 Adapters.

The No. 142 Type Condensers require one No. 27A Bracket when mounted in place of the No. 21 or similar Type Condensers. Arranged to mount on 1/2" horizontal and 1 3/4" vertical centers. Furnished with two nuts and washers for mounting. Safe continuously applied voltage, either DC or effective AC at 60 cycles or less and of an approximate sine wave, is 300 volts.

Code No.	Fig. No.	Capacity M.F.				Tested On Voltage	Remarks
		Min.	Stamped ON Condenser At		Max.		
			A	B			
57N	..	2	500 D.C.	Maximum variation M.F. plus 35%
57QF	..	2.14	2.18	500 D.C.	..
138A	1	1.00	1	..	1.25	1000 A.C.	Replaces No. 21AA Condenser except for "Additions and Maintenance Only"
138B	..	1.25	1.25	..	1.57	1000 A.C.	Used in No. 160C Selector Set
138QA	2	1.07	1.07	1.09	1.09	1000 A.C.	..
138QB	2	1.04	1.04	1.12	1.12	1000 A.C.	..
139A	1	2.00	2	..	2.50	500 D.C.	Replaces No. 90B Condenser
139C	2	1.00	1	..	1.25	500 D.C.	Replaces No. 90A Condenser
139QA	3	2.14	2.14	2.18	2.18	500 D.C.	Replaces No. 90C Condenser
139QC	3	2.16	2.16	2.22	2.22	500 D.C.	Replaces No. 21BE Condenser
141A	2	1.00	1	..	1.25	500 D.C.	Replaces No. 39H Condenser
*141H	1	.02	.02	.02	.03	500 D.C.	Replaces No. 21AH Condenser
141QF	2	1.08	1.08	1.14	1.14	500 D.C.	Replaces No. 21AM Condenser
141QP	2	.26	.26	.28	.28	500 D.C.	..
142B	2	.25	.25	..	.32	1000 A.C.	Replaces Nos. 21Y and 21AL Condensers
142D	2	.05	.05	..	.06	1000 A.C.	Replaces No. 21U Condenser

*Values stamped at "A" are measured between terminals 1 and 2 and values at "B" are measured between terminals 3 and 4. Consists of two separate condensers insulated but not shielded from each other. These condensers should be used bridged off or across two separate transmission circuits and should not be used in the same circuit where the effect of the capacity between separate units will be detrimental to transmission.

CONDENSERS—CABINET TYPE

Code No.
160B

Description

Consists of 16 No. 130AB Condensers mounted in a steel cabinet. Overall dimensions including mounting lugs, 8 1/4" long x 6 1/4" wide x 5" deep. Has a capacity of 20 M.F. For illustration, see above.

Use

In A.C. Train Dispatching Circuits when selectors are operated through a transformer or repeating coil and are connected in series with the primary winding of the repeating coil. Replaces the No. 160A Condenser.

RAILWAY TRAIN DISPATCHING TELEPHONE SYSTEMS

Condensers (Continued)—Unmounted

These condensers are of the tinfoil and paper type. The paper dielectric used in separating the tinfoil plates is prepared under rigid specifications from specially selected stock and its high and uniform quality contributes materially to the excellence of the product obtained.

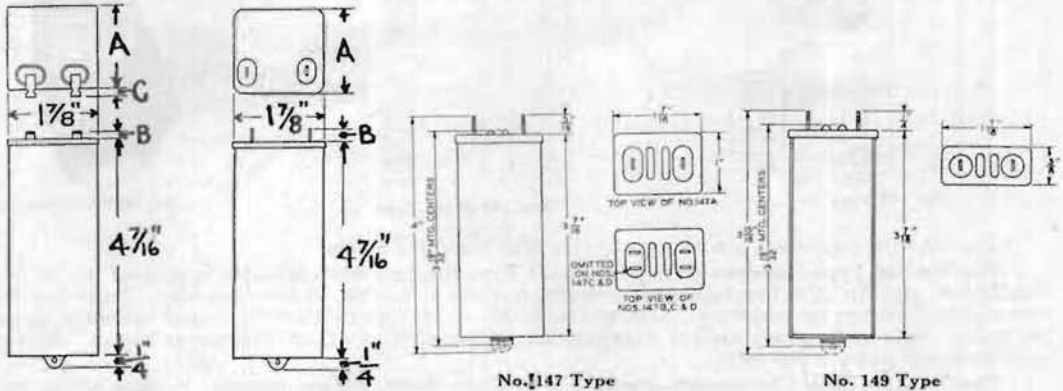

Fig. 1 Bent Terminals
Fig. 2 Straight Terminals
No. 21 Type

Code No.	Capacity Microfarads	Fig. No.	Dimensions, Inches			Voltage Tested On	Used in Sets
			A	B	C		
21H	0.1	1	1	5/32	1/8	1200 D.C.	Interruption
21J	0.3 & 0.3	2	1	11/32	..	500 A.C.	3 terminals
21S	.125, .25 & .5	2	1	13/32	..	500 D.C.	Telegraph, 4 terminals
21AA	1.0	1	1 21/32	5/32	1/8	1000 A.C.	160, 295, 300, 1293, 1317 & 1336
21AK	0.5	1	1	5/32	1/8	1000 A.C.	Telegraph
21BA	0.01	1	1	5/32	1/8	1000 A.C.	160
21BJ	{Max. 2.512 Min. 2.488}	2	1 21/32	11/32	..	500 D.C.	{“For Additions and Maintenance Only” Nos. 139QC and 141QP in parallel recommended

The Nos. 147 and 149 Type Condensers are equipped with mounting tabs at lower edge of condenser and may be mounted by means of this tab and a mounting strap.

Safe continuously applied voltage either DC or effective AC at 60 cycles or less and of an approximate sine wave, is 180 volts.

If No. 147 Type Condenser when substituted must fill space of No. 21 Type, order should specify P-409555 Adapter, and for the No. 149 Type Condenser, specify P-409556 Adapter.

Code No.	Capacity M.F.			Voltage Tested On	Used in Sets
	Max.	Stamped At	Min.		
147A	2.50	A .. B 2.00	2.00	500 D.C.	General, 311A, 1312A, 1314A Sets. Replaces Nos. 21D, E and L Condensers
147B	{1.25 1.25 1.25	{1.00 .. 1.00	{1.00 1.00 1.00	500 D.C.	General. Replaces No. 21BG Condenser
*147C	{1.25 1.25	{1.00 ..	{1.00 1.00	500 D.C.	Composite. Replaces No. 21AD Condenser
*147D	{1.25 .62	{1.00 ..	{1.00 .5	500 D.C.	Coil Racks. Replaces No. 21N Condenser

*Values stamped at “A” are measured between terminals 1 and 2, values stamped at “B” are measured between terminals 1 and 3.

Code No.	Capacity M.F.			Voltage Tested On	Used in Sets
	Max.	Stamped On Condenser	Min.		
149A	1.25	1.	1.0	500 D.C.	General, 502, 1311A, 1312, 1314, 1330, 1331, 1332 Sets. Replaces Nos. 21F, K, W and BW Condensers
149B	.62	.5	.50	500 D.C.	General. Replaces Nos. 21AC and AS Condensers
149C	.13	.1	.10	500 D.C.	General. Replaces No. 21R Condenser
149D	.80	.65	.65	500 D.C.	General. Replaces No. 21BF Condenser

RAILWAY TRAIN DISPATCHING TELEPHONE SYSTEMS

CONDENSER MOUNTINGS

Condenser Adapters

- P-127145 Galvanized iron, overall dimensions $1\frac{1}{32}'' \times \frac{1}{2}''$.
- P-409555—Wood, overall dimensions $4\frac{1}{16}'' \times 1\frac{1}{16}''$.
- P-409556—Wood, overall dimensions $4\frac{1}{16}'' \times 1\frac{1}{16}''$.

Condenser Brackets



No. 24 Type

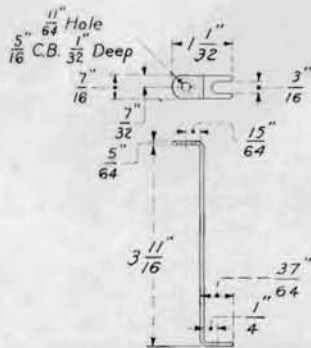

No. 24A



No. 24B



No. 24C



No. 24D

- 24A—Steel, aluminum finish, overall dimensions $3\frac{11}{16}'' \times \frac{7}{16}'' \times 1\frac{1}{32}''$.
- 24B—Steel offset, aluminum finish, overall dimensions $3\frac{11}{16}'' \times \frac{7}{16}'' \times 1\frac{1}{32}''$.
- 24C—Steel offset, aluminum finish, overall dimensions $3\frac{11}{16}'' \times \frac{7}{16}'' \times 1\frac{1}{32}''$.
- 24D—Steel offset, aluminum finish, overall dimensions $3\frac{11}{16}'' \times \frac{7}{16}'' \times 1\frac{1}{32}''$.
- 27A—Steel, aluminum finish, overall dimensions $1\frac{1}{2}'' \times 1\frac{1}{8}'' \times 1''$.
- 27B—Steel, aluminum finish, overall dimensions $1\frac{1}{2}'' \times 1\frac{1}{16}'' \times 1''$.
- 27C—Steel, aluminum finish, overall dimensions $1\frac{1}{2}'' \times 3\frac{1}{4}'' \times 1''$.
- 27D—Steel, aluminum finish, overall dimensions $1\frac{1}{2}'' \times 2\frac{7}{16}'' \times 1''$.



No. 27 Type

Condenser Straps

- P-43065—A straight galvanized iron strap, overall dimensions $4\frac{1}{16}'' \times \frac{1}{2}''$.
- P-43121—A galvanized iron clamp, overall dimensions $5\frac{5}{16}'' \times \frac{9}{16}''$.
- P-49022—A straight galvanized iron strap for mounting two condensers, overall dimensions $9\frac{5}{8}'' \times \frac{1}{2}''$.

RAILWAY TRAIN DISPATCHING TELEPHONE SYSTEMS

CONNECTING BLOCKS AND BRIDGING CONNECTORS



No. 1A

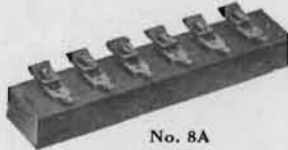

No. 8A

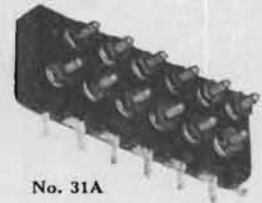

No. 31A



No. 11A

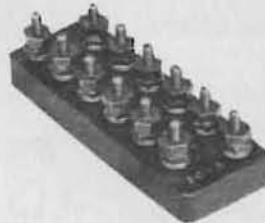

No. 30A



No. 12E

CONNECTING BLOCKS

Code No.	No. of Connectors	Type of Connector	Size of Base, Inches			Material Base
			Length	Width	Thickness	
1A	3	Binding Post Type Cord tip terminal Two screw terminals on each connector electrically connected	$2\frac{1}{2}$	$2\frac{1}{2}$	$\frac{1}{2}$	Composition
8A	6		5	1	$\frac{5}{8}$	Ebonized Wood
11A	2		$1\frac{1}{8}$	$1\frac{1}{2}$	$\frac{3}{16}$	Composition
11B	2		$1\frac{1}{8}$	$1\frac{1}{2}$	$\frac{3}{16}$	Composition

The No. 11B Connecting Block is the same as the No. 11A, except that it is equipped with a black finished metal cover.

12E	3	Two screw terminals on each connector electrically connected. Equipped with Cord Fasteners.	$1\frac{11}{16}$	$1\frac{3}{8}$	$\frac{3}{16}$	Composition
12F	3		$1\frac{11}{16}$	$1\frac{3}{8}$	$\frac{3}{16}$	Composition

The No. 12E Connecting Block is the same as the No. 12F, except that it is equipped with a black finished metal cover.

30A	12	Consists of sets of binding posts molded into the block arranged in $\frac{5}{8}$ " centers in two rows, $\frac{3}{4}$ " apart and staggered	$4\frac{3}{16}$	$1\frac{1}{2}$	$\frac{1}{2}$	Composition
30B	22		$7\frac{3}{16}$	$1\frac{1}{2}$	$\frac{1}{2}$	Composition
30C	32		$10\frac{1}{16}$	$1\frac{1}{2}$	$\frac{1}{2}$	Composition
30D	52		$16\frac{11}{16}$	$1\frac{1}{2}$	$\frac{1}{2}$	Composition

The No. 30 Type Connecting Blocks are equipped with nuts and washers for connecting distributing wires.

31A	12	Each connector has one lock nut binding post and one soldering terminal, brought out on the side, otherwise same as No. 30 Type	$4\frac{3}{16}$	$1\frac{1}{2}$	$\frac{1}{2}$	Composition
31B	22		$7\frac{3}{16}$	$1\frac{1}{2}$	$\frac{1}{2}$	Composition
31C	32		$10\frac{1}{16}$	$1\frac{1}{2}$	$\frac{1}{2}$	Composition
31D	52		$16\frac{11}{16}$	$1\frac{1}{2}$	$\frac{1}{2}$	Composition

RAILWAY TRAIN DISPATCHING TELEPHONE SYSTEMS

CORDS

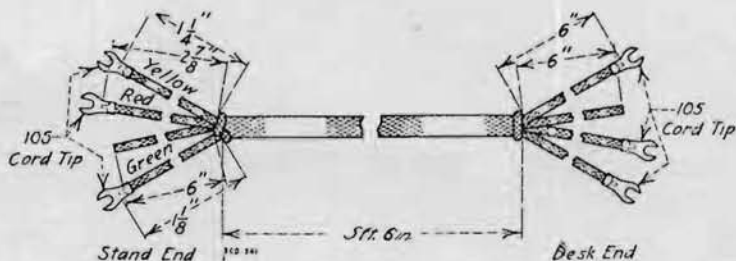

No. 541 Cord

Note: The length of receiver, desk stand and transmitter arm cord is measured between the points where the conductors emerge from the external braiding.

Desk Stand and Transmitter Arm Connecting Cords

Code No.	Type and Covering	Conductors	Cord Tips		Tracer Colors	Standard Length	Desk Stand	Used with	
			Trans. or Rec. End	Set End				Desk Stand	Transmitter Arm
409	Moisture-proofed	3	103	103	Red, Yellow, Green	6'	1020AB, 1120AB, 1042AB & 1142AB	1048DA, DB, DC & DD, 1148DA, DB, DC & DD, 1020C & 1120C	
416	Moisture-proofed	4	103	103	Red, Green, Blue, Yellow	6'	1020BR & 1042BR	1048GA, GB, GC & GD	
423	Moisture-proofed	1	61	103	Maroon	9 1/4"	1020 & 1042BR	1048 & 1148 Type	
426	Moisture-proofed	1	98	103	Yellow	9 3/8"	1020AB & BR, 1120AB, 1042AB & BR & 1142AB (Replaces 330 cord)	1020C & E, 1120C, 1048DA, DB, DC & DD, 1148DA, DB, DC & DD	
427	Moisture-proofed	1	98	103	Black	9 3/8"	1020AB & BR, 1042AB & BR & 1120AB & 1142AB	1048DA, DB, DC & DD, 1020E, 1148DA, DB, DC & DD	
541	Water-proofed	3	105	105	Red, Yellow, Green	5'6"	1020 & 1042 Type	1048 & 1148 Type	
550	Tinsel Silk	3	103	103	Red, Yellow, Green	5'6"	1020AL, 1040AL	1020CC	
554	Moisture-proofed	2	69	103	White, Green	2'6"	1020AB & BR, 1042AB & BR, 1120AB & 1142AB	1048DA, DB, DC & DD, 1148DA, DB, DC & DD using No. 186 & 189 Receivers, 1020C & 1120C	
571	Tinsel Silk	2	69	103	White, Red	5'6"	1020 or 1040 Type (using 190 Receiver)		
450	Combination cord for use with 1020AL and 1040AL Desk Stand, consists of 550 cord 5 1/2 ft. R2A Cord 2 1/2 ft., and two T1A Cords, 9 3/8 inches.								

The following are new coded type cords. The first letter of the code number indicates the type of apparatus with which the cord is used and the middle number represents the number of conductors in the cord. For example, D4E is a desk stand cord having 4 conductors.

Code No.	Type and Covering	Conductors	Cord Tips		Tracer Colors	Standard Length	Desk Stand	Used with	
			Trans. or Rec. End	Set End				Desk Stand	Transmitter Arm
D3A	Moisture-proofed	3	..	103	Green, Red, Yellow	5'6"	1020AL		
D3D	Moisture-proofed	3	..	103	Green, Red, Yellow	6'	1020AB, 1042AB, 1120AL & 1220PC	1020C, D, E and 1120C	
D4E	Moisture-proofed	4	103	103	Green, Red, Yellow, Blue	5'6"	1020U & 1040U (Replaces 365 Cord)		
D4G	Moisture-proofed	4	103	103	Green, Red, Yellow, Blue	6'	1020BR & 1042BR	1020E	
R2A	Tinsel Silk	2	103	103	Green, White	2'6"	20 & 40 Types (Replaces 549 Cord)	1020CC	
R2U	Moisture-proofed	2	69	103	Green, White	2'6"	1020AB, 1042AB, 1020BR, 1120AB, 1142AB & 1042 BR	1020C, D, E, 1120C	
R2Y	Tinsel Silk	2	103	103	Green, Red	2'6"	1020U & 1040U (Replaces 412 Cord)		
T1A	Moisture-proofed	1	98	103	Yellow	1'	1020U & 1040U (Replaces 547 Cord)	1020CC	

RAILWAY TRAIN DISPATCHING TELEPHONE SYSTEMS

Telephone Set Cords (Continued)

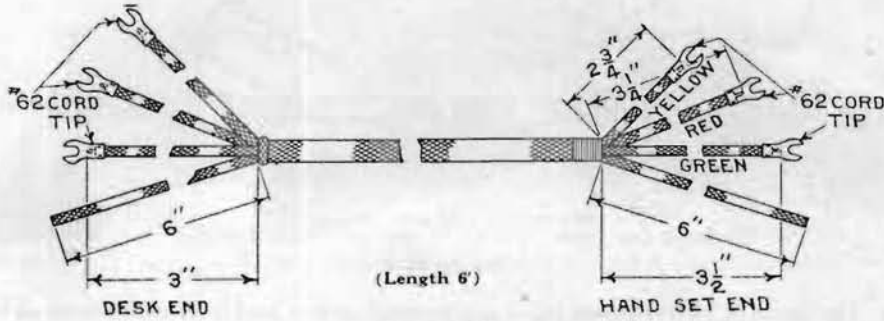

No. 422 Cord

Note: The length of receiver, desk stand and transmitter arm cord is measured between the points where the conductors emerge from the external braiding.

Wall Telephone Transmitter and Receiver Cords

Code No.	Type and Covering	Conductors	Cord Tips		Tracer Colors	Standard Length	Used with Telephone Sets
			Trans. or Rec. End	Set End			
329	Tinsel Silk	1	98	103	Brown	9 3/4"	1293 Type
384	Water-proofed	2	105	105	White, Green	10 1/2"	1336F & H, 1314A
385	Water-proofed	1	56	105	Black	7"	1336F & H, 1305AC
422	Water-proofed	3	62	62	Yellow, Red, Green	6'	1278G & H (for hand set)
446	Moisture-proofed	2	29 & 76	103	White, Green	10 1/2"	1317W & AD, 1305AC, 1293AD & AK
521	Tinsel Worsted	2	105	105	White, Green	2'6"	1312A, 1317P, S, AH, BK, CN, CR, CP, CS & CG
540	Stranded Cotton	1			Brown	5"	1317 Types, 1336F & H, 1330E & F Battery Cord
546	Moisture-Proofed	2	69	103	White, Green	2'	1317 Type, 1293AE & AL with 186 Receiver
T1A	Moisture-proofed	1	98	103	Yellow	9 3/4"	1375B & 1398A (Replaces 547 Cord)

Portable Telephone, Test Set and Hand Set Cords

Code No.	Type and Covering	Conductors	Cord Tips		Tracer Colors	Standard Length	Used with Telephone Sets
			Rec. End	Set End			
243	Tinsel Cotton	1	103	103	Brown	8"	1375B & 1398A with 1001H Hand Sets
366	Water-proofed	3	105	105	Red, Yellow, Green	6'	1330, 1331 & 1332 Types with 1001C Hand Set
384	Water-proofed	2	105	105	Green, White	10 1/2"	1336F & H, 1314A
422	Water-proofed	3	62	62	Yellow, Red, Green	6'	1278G & H with 1001F Hand Set
509	Water-proofed	2	105	22	Black	6'	1330 & 1331 Types, using 146 Plug
523	Water-proofed	2	30	30	Red, White	2'	1017B, C, E and 1006D Test Sets
537	Water-proofed	2	30	30	Red, White	4'	19A Test Set
545	Tinsel Silk	2	104	103	Green, Red	6'	Portable Telephone with 148 Plug
572	Water-proofed	2	78	30	White, Red	2'	1017 Test Set with 515 Receiver
574	Water-proofed	1	105	Special	Black	5'	1375B, 1398A using 1001A Hand Set
M1A	Water-proofed	1	Special	22	Black	100'	No. 4 Line Pole
M2J	Water-proofed	2	62	22	Black	100'	No. 3 Line Pole
M2K	Water-proofed	2	62	22	Black	100'	No. 5 Line Pole

RAILWAY TRAIN DISPATCHING TELEPHONE SYSTEMS

Cords (Continued)

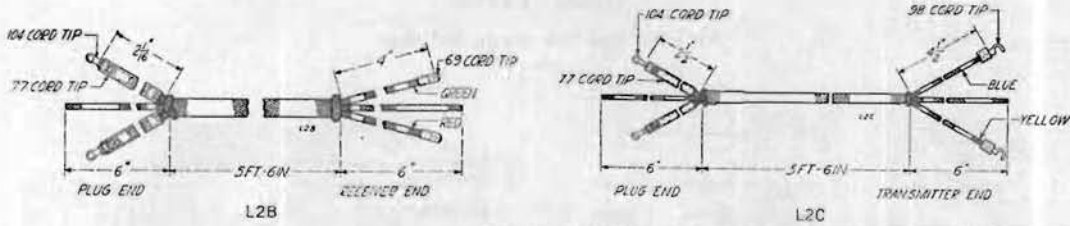

Note: The length of receiver, desk stand and transmitter arm cord is measured between the points where the conductors emerge from the external braiding.

Dispatchers' and Operators' Head Set Receiver Cords

Code No.	Type and Covering	Conductors	Cord Tips		Standard Length	Used with
			Trans. or Rec. End	Set or Plug End		
363	Tinsel Cotton	4	29, 106 & 98	104	6'	137 Plug on 147W or 153W Double Head Receiver and 283W or 386 Transmitter, series connection (see 566)
364	Tinsel Silk	2	29	103	6'	147W Double Head Receivers in series, and 20 or 40 Type Desk Stand
375	Moisture-proofed	4	29 & 98	104	6'	137 Plug for dispatchers head receiver and chest transmitter (see 565)
565	Moisture-proofed	4	69 & 98	104	5'6"	137 Plug for dispatchers head receiver and chest transmitter where 189 receiver is used (see 375)
566	Moisture-proofed	4	69 & 98	104	5'6"	137 Plug on 190 Receiver and 283W Transmitter, 1010A Head Set and 386 Transmitter (series connection; see 363)
L2B	Moisture-proofed	2	69	104 & 77	5'6"	189 or similar type receiver
L2C	Moisture-proofed	2	*98	104 & 77	5'6"	386 or similar type transmitter
L6A	Tinsel Silk	6	29 & 98	38 & 104	6'	Operators parallel double head receiver and breast transmitter

*The shanks of the 98 Cord Tip are insulated.

Test Board and Switchboard Patching Cords

Code No.	Type and Covering	Conductors	Cord Tips		Standard Length	Used with
			Rec. End	Set End		
*513	Moisture-proofed	1	—	103	2'	116 Plug with test boards.
*519	Moisture-proofed	1	—	103	3'	116 Plug with Test Board 2A, 2B and 3A
525	Tinsel Cotton	2	—	—	3'	Double conductor patching cord with W. U. 3A Plug
526	Tinsel Cotton	2	—	—	5'	For joining two duplex sets terminated at switchboard jack for use as a repeater
527	Tinsel Cotton	2	—	—	3'	"Y" patching cord to connect two loops or sets to one looping jack or to transfer a group of loops or sets from one circuit to another
537	Water-proofed	2	30	30	4'	19A Test Set using receiver
584	Water-proofed	2	80	30	4'3"	Two 528 Receivers on 19A Test Set
736	Water-proofed	2	62	62 & 27	6'	17 type Test Sets
747	Water-proofed	2	80	30	4'	19C Test Set for receiver. (528)
P1A	Moisture-proofed	1	75	75	2'	116 Plug for switchboard patching. (Replaces 510)
P1B	Moisture-proofed	1	104	104	2'	47 Plug for switchboard patching. Tip connection only (Replaces 637)
P2A	Moisture-proofed	2	104	104	3'	47 Plug for switchboard patching. (Replaces 516)
P2B	Moisture-proofed	2	101 & 102	101 & 102	3'	110 Plug for switchboard patching. (Replaces 515)
S1A	Moisture-proofed	1	75	93 & 45	6'3"	116 Plug for switchboard. (Replaces 511)
S1B	Moisture-proofed	1	102	93 & 45	6'3"	110 Plug for switchboard. Tip connection only. (Replaces 723)

*External braiding of glazed cotton furnished in red, white, black and green. White will be furnished unless otherwise specified.

RAILWAY TRAIN DISPATCHING TELEPHONE SYSTEMS

CORD TIPS

All cord tips are made of brass

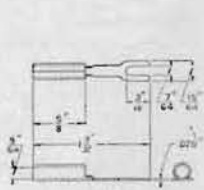

No. 8
Tinned

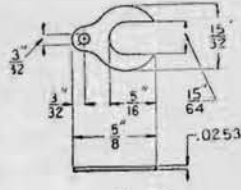

No. 22
Tinned

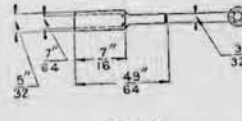

No. 29
Nickel Plated



No. 30
Nickel Plated

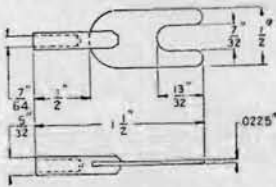

No. 35
Nickel Plated

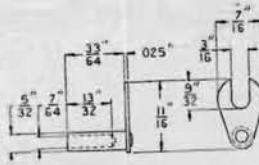

No. 37
Nickel Plated

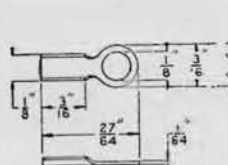

No. 38
Tinned

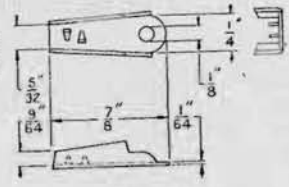

No. 45
Brass

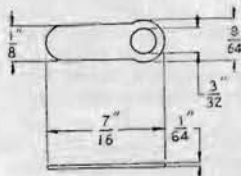

No. 47
Tinned

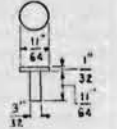

No. 55
Tinned

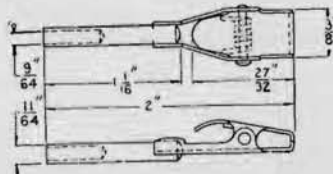

No. 59
Nickel Plated

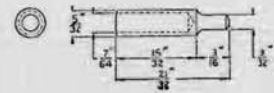

No. 61
Nickel Plated

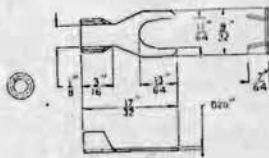

No. 62
Tinned

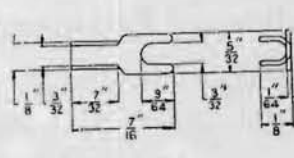

No. 70
Tinned

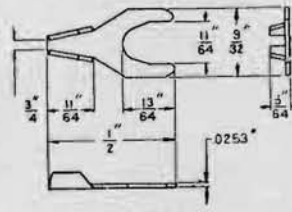

No. 72
Tinned

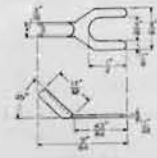

No. 74
Tinned

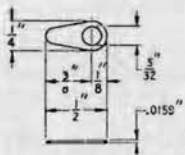

No. 75
Tinned

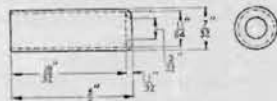

No. 76
Rubber



No. 78
Nickel Plated

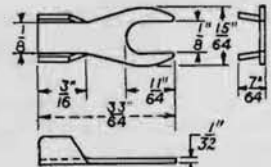

No. 79
Tinned

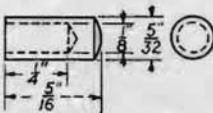

No. 80
Nickel Plated



No. 85
Tinned



No. 86
Tinned



No. 87
Tinned

RAILWAY TRAIN DISPATCHING TELEPHONE SYSTEMS

Cord Tips (Continued)

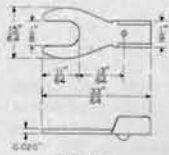

No. 91
Tinned

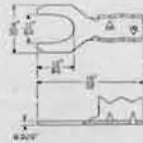

No. 92
Nickel Finished

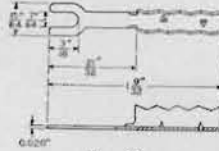

No. 93
Nickel Finished

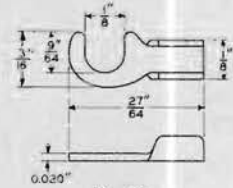

No. 97
Tinned

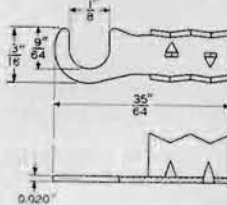

No. 98
Nickel Finished

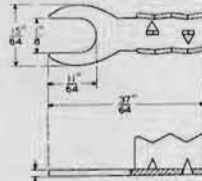

No. 100
Nickel Finished

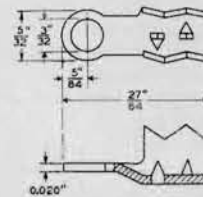

No. 101
Nickel Finished

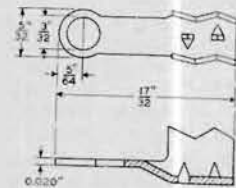

No. 102
Nickel Finished

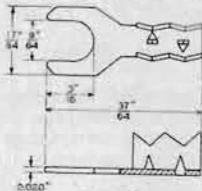

No. 103
Nickel Finished

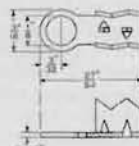

No. 104
Nickel Finished

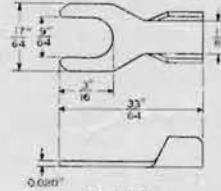

No. 105
Tinned

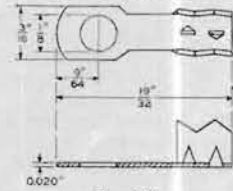

No. 109
Nickel Finished

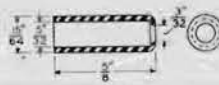

No. 106
Rubber

Cord Tips

Code No.

- 8 Tinned. For use on switchboard cords in connection with Nos. 8 and 9 cord fasteners. Replaces No. 42.
- 22 Flat, tinned for fastening under binding post or screw. Slotted for No. 12 screw. Replaces No. 43.
- 29 Nickel plated. Ordinarily used on silk covered cords in connection with drilled binding posts. Replaces No. 10. Recommended in place of No. 31.
- 30 Nickel plated. Ordinarily used on worsted or cotton covered cords in connection with drilled binding posts. Replaces Nos. 13 and 20. Recommended in place of No. 31.
- 35 Nickel plated. For use in connection with bracket transmitters. Slotted for No. 12 screw.
- 37 Nickel plated, nickel silver tip with nickel plated brass shank; for use in connection with bracket transmitters. Slotted for No. 8 screw. Replaces No. 25.
- 38 Tinned, eyelet tip; for use on plug end of switchboard cords. Replaces No. 41.
- 45 Eyelet tip; for use on stay cord end of switchboard cords.

Code No.

- 47 Tinned, eyelet tip; for use on plug end of switchboard cords. Replaces Nos. 23 and 27.
- 55 Tinned; for use with transmitter cords.
- 59 Nickel plated, brass spring tip with one-piece shank.
- 61 Nickel plated; for use with drilled binding posts where a short tip is required. Replaces No. 60.
- 62 Tinned. Slot beveled to admit either a No. 6 or No. 8 screw. Replaces Nos. 1, 53, 54 and 58.
- 70 Tinned; for use in connection with battery gauges.
- 72 Tinned; for fastening under binding post or screw. Ordinarily used on transposition leads in subscriber sets.
- 74 Open end tinned, with a soldering lug of semi-circular section bent up at an angle of 45 degrees. Intended for use as a connection between the ends of the bridle wires and the upper ends of the No. 51A Fuse, both of which are a part of the No. 93A Protector.
- 75 Tinned; for fastening under No. 116 plug connecting screw.
- 76 Semi-hard rubber sleeve intended to cover the exposed portion of the No. 30 cord tip.

RAILWAY TRAIN DISPATCHING TELEPHONE SYSTEMS

Cord Tips (Continued)

<p>Code No.</p> <p>78 Nickel plated; for drilled binding posts. Used on such cords as the No. 572.</p> <p>79 Tinned; for fastening under binding post or screw.</p> <p>80 Nickel plated; for use with high efficiency receivers.</p> <p>85 Tinned; for fastening under binding post or screw. Slotted for Nos. 6 or 8 screw.</p> <p>86 Tinned; for fastening under binding post or screw. Slotted for Nos. 6 or 8 screw.</p> <p>87 Tinned; for fastening under binding post or screw. Slotted for No. 4 screw.</p> <p>91 Tinned. Slotted for No. 4 screw.</p> <p>92 Solderless, nickel finished; having two tangs for making contact with conductors on cords having tinsel conductors. Slotted for Nos. 6 or 8 screw.</p> <p>93 Solderless, nickel finished; having two tangs for making contact with conductors on switchboard cords having tinsel conductors. Used in connection with Nos. 8 and 9 cord fasteners.</p> <p>97 Tinned; for use on transmitter and hand set cords. Slotted for No. 4 screw. Partially replaces No. 56.</p>	<p>Code No.</p> <p>98 Solderless, nickel-finished; having two tangs for making contact with tinsel conductor. For use on transmitter cords. Slotted for No. 4 screw. Partially replaces No. 56.</p> <p>100 Solderless, nickel-finished; having two tangs for making contact with tinsel conductor. For use on hand set cords. Slotted for No. 4 screw.</p> <p>101 and 102 Solderless nickel-finished; having two tangs for making contact with tinsel conductor. For use on ring and tip conductors respectively of cords arranged for Nos. 109 and 110 type plugs.</p> <p>103 Solderless nickel-finished; having two tangs for making contact with tinsel conductors. Slotted for No. 6 screw.</p> <p>104 Solderless nickel-finished; having two tangs for making contact with tinsel conductor. For use on cords arranged for Nos. 47 and 137 type plugs.</p> <p>105 Tinned; for use on station cords. Slotted for No. 6 screw.</p> <p>106 Semi-hard rubber sleeve intended to cover the exposed portion of the No. 29 cord tip.</p> <p>109 Solderless nickel-finished; having two tangs for making contact with tinsel conductor.</p>
---	---

DESIGNATION STRIPS

No. 8G Designation Strip

These consist of a black finish metal retaining strip.

The No. 8 type has a transparent celluloid strip for protecting a strip of printed figures. Mounting screws are furnished.

The 43 type is arranged to mount a strip of printed figures. Furnished with mounting screws.

The Nos. 90A and 90B have a transparent celluloid strip for protecting a strip of printed figures. Mounting screws are furnished.

The No. 90A is intended to mount on Nos. 184, 185 and 194A Jack Mountings and No. 262 Lamp Socket Mountings. Is arranged to accommodate a designation card for each pair of jacks or lamps.

The No. 90B is intended to mount on Nos. 128 and 129 Jack Mountings and arranged to accommodate a designation card for each pair of jacks.

Code No.	Width	Length	Code No.	Width	Length	Code No.	Width	Length
8G	$\frac{7}{16}$ "	Specify	8P	$\frac{7}{16}$ "	$22\frac{3}{16}$ "	43B	$\frac{39}{64}$ "	$1\frac{1}{2}$ "
8H	$\frac{3}{8}$ "	Specify	8R	$\frac{7}{16}$ "	$27\frac{5}{16}$ "	43C	$\frac{39}{64}$ "	$1\frac{1}{4}$ "
8K	$\frac{5}{8}$ "	$6\frac{1}{8}$ "	8S	$\frac{7}{16}$ "	$19\frac{47}{64}$ "	43D	$\frac{3}{4}$ "	$1\frac{1}{4}$ "
*8L	$\frac{7}{16}$ "	Specify	*8U	$\frac{5}{8}$ "	Specify	90A	$\frac{7}{16}$ "	$15\frac{1}{16}$ "
*8M	$\frac{3}{8}$ "	Specify	**8AB	$\frac{7}{16}$ "	Specify	90B	$\frac{5}{8}$ "	$6\frac{3}{16}$ "

*Ends of metal retaining strip are turned up to prevent strips from slipping out.

**Replaces No. 8N.

RAILWAY TRAIN DISPATCHING TELEPHONE SYSTEMS

DESK STANDS



No. 1042AB Desk Stand



No. 1020AL Desk Stand

Desk Stands

The following Bower-Barff finished steel desk stands with the exception of the 1020AL which is a brass desk stand with a black japan finish, are for use with the various telephone circuits, as indicated. The entire terminal plate and switch hook assemblies of these stands may be withdrawn from the stem and base assembly for inspection without disconnecting the cords or interrupting the service in any way. This is accomplished by removing one screw from the bottom of the base plate.

The bottom and edge of the base plate is covered with felt. All current carrying parts are insulated from the frame.

The No. 1020AL Desk Stand is for local and central battery lines.

The No. 1040U Desk Stand is for railway composite service and replaces the No. 1020U Desk Stand.

The No. 1042AB Desk Stand is used in train dispatching circuits, where insulated transmitters and head receivers are required and where a foot switch or a No. 465C Key is used. This desk stand replaces the No. 1020AB.

The No. 1042BR Desk Stand is used in train dispatching circuits where it is desired to insulate the primary circuit from the secondary to prevent noises from the ringing selector. Replaces 1020BR.

The No. 1142AB Desk Stand is for use with the Nos. 501A and B Desk Set Boxes at way stations of train dispatching lines. This desk stand replaces the No. 1120AB Desk Stand.

Code No.	Transmitter No.	Receiver No.	Cords Receiver	Cords Transmitter	Cords Desk Stand
1020AL	323	144	R2A—2½'	2-T1A—9⅞"	D3A—5½'
1040U	323	144	R2Y—2½'	2-T1A—9⅞"	D4E—5½'
1042AB	349	186	R2U—2½'	2-427—9⅞"	D3D—5½'
1042BR	349	186	R2U—2½'	2-427—9⅞"	D4G—8'
1142AB	349	189	R2U—2½'	2-427—9⅞"	D3D—5½'

RAILWAY TRAIN DISPATCHING TELEPHONE SYSTEMS

Desk Stands (Continued)

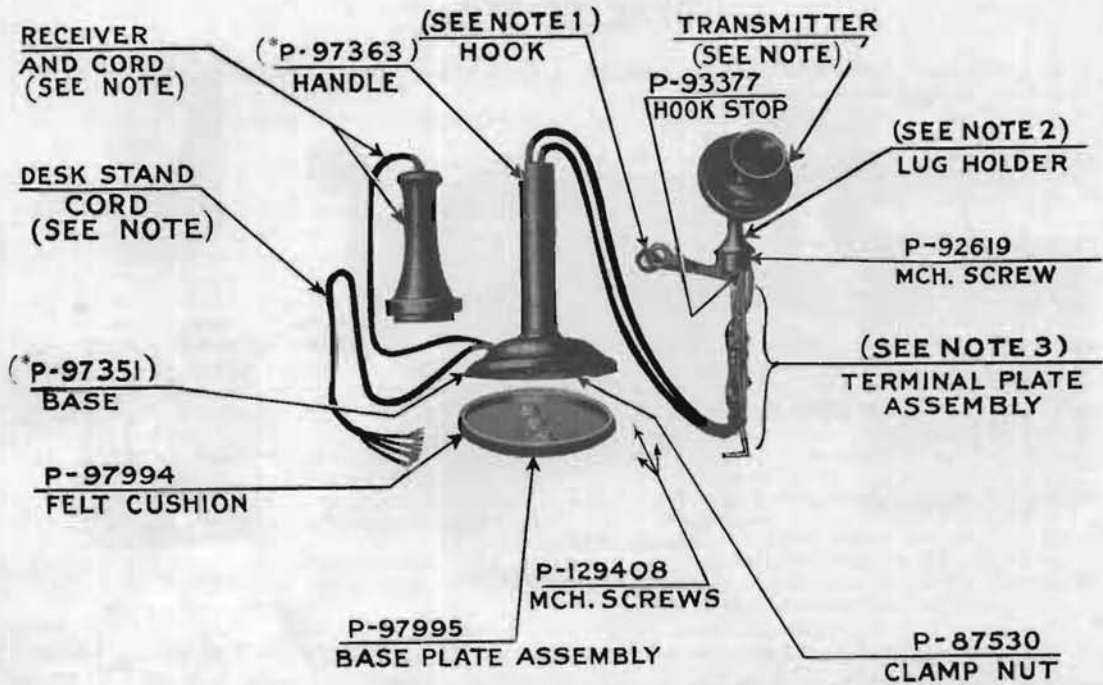

Desk Stands—Replacement Parts

*Replacement part numbers for the Handle and Base of the No. 1020AL Desk Stand are as follows. Handle P-98886, Base P-98891.

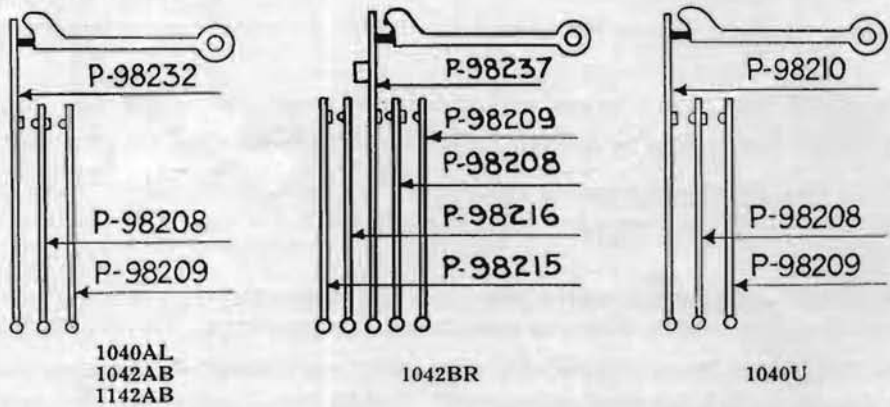

Contact Springs—Replacement Parts

Note: The receiver, transmitter, etc., are given in the code number listings of the desk stand. (Page 45.)

	Note 1	Note 2	Note 3
	Hook	Lugholder	Terminal Plate Assembly
1020AL	P-98883	P-98862	P-98247
1040U	P-97343	P-97372
1042AB	P-97348	P-97374	P-98247
1042BR	P-97348	P-97842
1142AB	P-97348	P-97374	P-98247

RAILWAY TRAIN DISPATCHING TELEPHONE SYSTEMS

**DESK SET BOXES
(Subscriber Sets)**



No. 295AJ Desk Set Box



No. 300 Type Desk Set Box



No. 502A



No. 501A Desk Set Box
Cover Removed

Dispatchers' Stations Desk Set Boxes

The following desk set boxes are used on train dispatching circuits in dispatchers' telephone sets, with head set telephone equipments consisting of the No. 386 Transmitter and the No. 189 Receiver:

Code No.	Condenser No.	Induction Coil No.	Remarks
295AJ	*138A	29	Replaced by No. 502A for new installations
502A	*1—No. 149A and 2—No. 21AK	43 and 44	Replaces No. 295AJ for new installations. See page 15 for open view

*When ordering this condenser to replace 21 type used in earlier equipment see notes under "Condensers" for type of bracket or adapter required.

Way Station Desk Set Boxes

The following desk set boxes are used on train dispatching circuits in way station telephone sets with desk stand, Flexiphones or transmitter arm, equipped with No. 349 Transmitter and No. 189 Receiver.

The No. 501B Desk Set Box, together with the No. 501A, replaces the No. 295AK on new installations.

Code No.	Retardation Coil	Condenser No.	Induction Coil No.	Remarks
295AK	51A	*138A	29	Used with earlier type equipment
Spec. 300K per D-11275	51A	*138A	29	Also equipped with No. 38BG Ringer and one No. 48A Hand Generator
501A	*142B	42	Equipped with one No. 1014A Push Button
501B	*142B	42	Arranged for No. 3C Foot Switch

*When ordering this condenser to replace 21 type used in earlier equipment see notes under "Condensers" for type of bracket or adapter required.

Composite Telephone Desk Set Box

The following desk set box is for use with the No. 1040U Desk Stand for desk type composite telephone set, for same class of service as the No. 1312A Telephone Set:

Code No.	Retardation Coil No.	Condenser No.	Induction Coil No.	Interrupter No.	Howler No.
311A	12G	21D, H & U	5	P-101594	1C

RAILWAY TRAIN DISPATCHING TELEPHONE SYSTEMS

Desk Set Boxes (Continued)

Magneto Telephone Desk Set Boxes

The following magneto telephone desk set boxes are for use where code ringing is employed, for the various line conditions as indicated.

The Nos. 300M and N Desk Set Boxes are the same as the Nos. 300K and L respectively, except having a condenser in series with the receivers.

Code No.	Ringer No.	Resistance	Condenser No.	Induction No.	Hand Generator No.	Remarks
300K	51BG	2500 ohms	13	48A	For heavily loaded lines
300L	51FG	1620 ohms	13	48A	For moderate loaded lines
300M	51FG	1620 ohms	*149A	13	48A	For moderate loaded lines
300N	51BG	2500 ohms	*149A	13	48A	For heavily loaded lines
315H	51AG	1020 ohms	13	22A	For light loaded lines

*When ordering this condenser to replace 21 type used in earlier equipment see notes under "Condensers" for type of bracket or adapter required.

FUSES



No. 24 Type Fuse

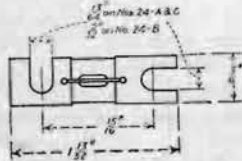

Nos. 35A, B, C & F

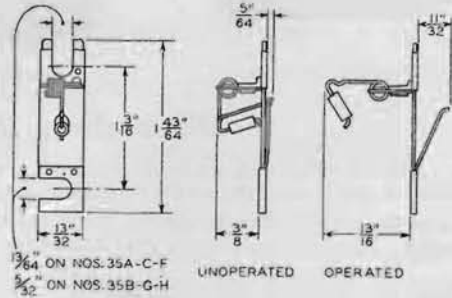

Non-Alarm Type

These phenol fibre fuses will mount on one inch centers by means of Fuse Posts or individual porcelain mountings as in the No. 62D Protector. The overall dimensions are: length 1 1/2", width 3/8".

The current carrying capacities and operating current values are given in the table below. In ordering, it is necessary that both the code number and rated capacity be given.

Code No.	Rated Capacity Amperes	Operates in Less Than One Minute on Amperes	Terminals	
			Finish	Slotted for Screw No.
24A	1 1/2	1	Tinned	10
	1 1/8	2	Tinned	10
	1 1/2	1	Copper	6
24B	1 1/3	2	Copper	6
	2	3	Copper	6
	3	4	Copper	6
24C	2	3	Copper	10

Indicator Alarm Type

These phenol fibre fuses have the fuse wire so mounted that one end is fastened to a coiled spring and the other to a flat spring on the opposite side of the base. The terminal ends have a copper tinned finish.

When the fuse operates, the coiled spring causes a glass bead to be brought into a prominent position where it acts as a visible indication of the blown fuse. The mounting of the fuse may be so arranged as to cause the flat spring on the bottom of the fuse to make contact with an alarm circuit when the fuse wire is broken.

RAILWAY TRAIN DISPATCHING TELEPHONE SYSTEMS

Fuses, Indicator—Alarm Type (Continued)

No. 35 Type Fuses may be mounted as in the No. 62C Protector or by means of Fuse Posts. They operate on currents fifty per cent in excess of those for which they are rated.

When ordering, both the code number and rated capacity should be specified.

Code No.	Rated Amperes	Operates On		Color of Bead	Slotted For Screw	Mounting Center
		Amperes	In Less Than			
35A	1½	2	1½ Min.	White	No. 10	1¼"
35B	1½	2	1½ Min.	White	No. 6	1¼"
35C	2	3	3 Min.	Yellow	No. 10	1¼"
35F	½	¾	1½ Min.	Red	No. 10	1¼"
35G	3	4½	5 Min.	Blue	No. 6	1¼"
35H	5	6½	5 Min.	Green	No. 6	1¼"

Tubular Fuses



No. 7A



No. 7T



No. 11C

These fibre shell type fuses are carefully made from especially selected materials. The use of lead fuse wire prevents the possibility of overheating the shell. These fuses will carry their rated currents indefinitely without injury and will act reliably on one and one-half times their rated current values. Fuses of the same code number and rated capacity will give consistent performance as to rated and operating current values.

Code No.	Rated Capacity Amperes	Used With
7A	1 to 7 as specified	Nos. 61, 77, 1074A, 1075A and 1078A Protectors
7T	7	"B" Cable Terminals and Fuse Chambers
11C	7	Nos. 58AP and 1079AP Protectors
11D	7	No. 25 Protector Mounting (No. 12 Type Protector)

PORCELAIN SHELL FUSES



No. 47A

In certain cases where lines are exposed to high potential crosses, it is advisable to insert a fuse in the drop wire near the cross arm in addition to the No. 60AP Protector installed at the telephone station. In such cases the No. 47 Type is recommended; the porcelain shell used on this type of fuse will break upon the passage of a large current or upon the continued flow of smaller current. The wires in which the fuses are inserted will fall apart as the shells break, and the line end of the wire, being close to the cross arm, will not come in contact with objects on the ground. These fuses operate on one and one-half times their rated capacity.

Code No.	Capacity
47A	7 amperes
47B	14 amperes

**RAILWAY TRAIN DISPATCHING TELEPHONE SYSTEMS
GENERATORS**



No. 48A

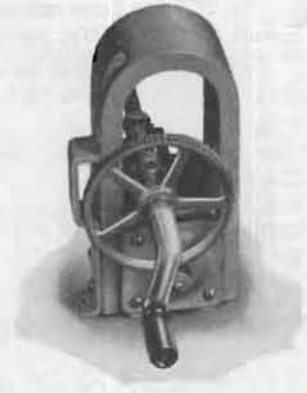
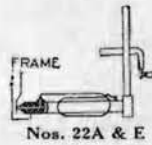

No. 29E

The following generators are used with desk set boxes and telephone sets as indicated. All of these generators are open circuit type. For repair part information on these generators refer to Telephone Apparatus and Supplies Catalog.

Code No.	No. of Bars	Voltage and Current	Used With
22A	3	60 AC	No. 303A, No. 315H Desk Set Boxes, No. 1317AH, No. 1331E and F Telephone Sets
29E	2	65 AC	No. 1375B and No. 1398A Telephone Sets
29F	2	60 AC	Nos. 1017D and E Test Sets
48A	5	80 AC	Nos. 300K, L, M, N Desk Set Boxes, Nos. 1317P, S, W, AD, AE, AW, BU, No. 1330E and F Telephone Sets
48C	5	80 AC	Nos. 1278G and H, No. 1336F and H Telephone Sets
48R	5	80 AC	No. 1317BK Telephone Set
50A	3	60 AC	Magneto Telephone Sets where a more efficient generator than the No. 22 Type is required
50F	3	60 AC	Nos. 1317CG, CN, CP, CS Telephone Sets

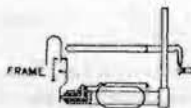

Nos. 48A, C & G



No. 299F

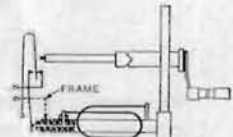

No. 29F

Hand Generator Box

A hand generator box consists of a generator mounted in an oak cabinet having a hinged cover. The leads from the generator are connected to terminals mounted close to the inside edge of the box.

Code No.	Generator	Current	Dimensions of Box		
			Width	Depth	Length
299F	48A	Alternating.....	8"	6"	9"

RAILWAY TRAIN DISPATCHING TELEPHONE SYSTEMS

GONGS AND GONG MOUNTINGS



No. 3



No. 10



No. 31A



No. 3 Gong Mounting



No. 7 Gong Mounting

Code No.	Diameter	Height	Metal and Finish	Where Used
3	2"	1 $\frac{3}{8}$ "	Metal, Nickel Plated	Cow gong
10	2 $\frac{15}{32}$ "	1 $\frac{11}{16}$ "	Metal, Nickel Plated	Tea gong. (A. & M. Only, 31A, 32A and 33A Recommended)
20	3"	1"	Brass, Black Finish	1336 Telephone Set
23A	8"	1 $\frac{3}{4}$ "	Steel, Galvanized	292 Type Extension Bell
26A	3"	1"	Brass, Black Finish	1317 Type Telephone Sets
28A	6"	1 $\frac{13}{32}$ "	Steel, Galvanized	392 Type Extension Bell
29A	2 $\frac{1}{2}$ "	3 $\frac{1}{64}$ "	Brass, Black Finish	Telephone Sets
31A	2 $\frac{1}{2}$ "	3 $\frac{1}{64}$ "	Brass, Black Finish	Differs from the 29A, in that each has a different tone intended for use where a number of telephones are placed close to each other
32A	2 $\frac{1}{2}$ "	3 $\frac{1}{64}$ "	Brass, Black Finish	
33A	2 $\frac{1}{2}$ "	3 $\frac{1}{64}$ "	Bell Metal, Black Finish	Recommended in place of Nos. 3 and 10

GONG MOUNTINGS

Each gong mounting consists of a pair of gong posts or gong post extenders together with the necessary mounting screws.

Code No.	Length of Post or Extender	Used With Gongs	Finish
3	1 $\frac{11}{16}$ "	Nos. 3 and 10	Nickel plated
7	1 $\frac{3}{16}$ "	Nos. 3 and 10	Brass

GONG NUTS

Code No.	Description	Dimensions			Finish
		Thread	Diameter	Height	
P19097	Knurled thumb nut used with No. 3 Gong Mounting	10-32	$\frac{1}{16}$ "	$\frac{1}{2}$ "	Nickel plated

RAILWAY TRAIN DISPATCHING TELEPHONE SYSTEMS

HAND SETS, HEADSETS AND HOWLERS

Hand Sets



No. 1001C Hand Set

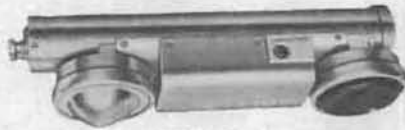

No. 1004B Hand Set



No. 1C Howler



No. 1010A Headset

Code No.	Transmitter	Receiver	Cords		Push Button Spring Combination	Principal Use
			Code No.	Length		
1001C	285	131	366	6' (water-proof)	2 make	Used with Nos. 1330 and 1331 Portable Magneto Telephone Sets Used with No. 1375B Portable Magneto Telephone Set Train Dispatching Circuits
1001H	244	131	422	5'2" (water-proof)	2 make	
1004B	244 per D-51130	131 per D-51129	2 make	

HEADSETS

Code No.	Description	Use
1010A	Consists of two 565A Receivers assembled on a 1C Headband. This headset replaces the 190 Receiver	For use in train dispatching way stations
1010B	Consists of one 565A Receiver assembled on a 1C Headband. This headset replaces the 191 Receiver	For use in train dispatching way stations

HOWLERS

Howlers consist of a special bipolar receiver with an adjustable diaphragm and a horn mounted on a wooden base. They are designed for use in calling in signal circuits.

Code No.	Approximate Total Resistance	Approximate Overall Dimensions
1C	1000 ohms	3 ¹³ / ₁₆ " x 6 ⁵ / ₁₆ " x 6 ¹ / ₄ "

INDUCTION COILS AND INTERRUPTERS

Induction Coils

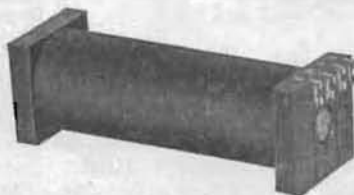

No. 5 Induction Coil



No. 13 Induction Coil

RAILWAY TRAIN DISPATCHING TELEPHONE SYSTEMS

Induction Coils and Interrupters (Continued)

Code No.	Size	Used In
5	4 ²⁹ / ₃₂ " x 1 ⁹ / ₁₆ "	Nos. 1312A, 1314A, 6023A Telephone Sets and 311A Desk Set Box
13	3 ³ / ₄ " x 1"	Nos. 300K, L, M, N and 315H Desk Set Boxes, 1317P, S, AH, BK, CN, CR, CP, CS and CG Telephone Sets, 1017B, C and E Test Sets
29	3 ¹ / ₄ " x 1"	Nos. 295AJ, AK and special 300H and K Desk Set Boxes, 1278G, H, 1293AD, AE, AK, AL, 1317W, AD, AE, AW, 1330E, F, 1331E, F, and 1332A, and E Telephone Sets
30	4 ¹ / ₄ " x 1 ³ / ₈ "	No. 1336H Telephone Set
31	3 ³ / ₄ " x 1"	No. 1375B Telephone Set. Moisture-proofed No. 13 Coil
32	3 ³ / ₄ " x 1"	No. 1336F Telephone Set, and No. 1004B Hand Set. Moisture-proofed No. 29 Coil
42	4 ¹ / ₄ " x 1 ²³ / ₃₂ "	No. 501 Desk Set Box for way stations, No. 1317 BU Telephone Set
43	4 ¹ / ₄ " x 1 ²³ / ₃₂ "	No. 502 Desk Set Box in transmitter circuits
44	4 ¹ / ₄ " x 1 ²³ / ₃₂ "	No. 502 Desk Set Box in receiver circuits

Interrupters



No. 62A Interrupter



No. 84H Interrupter

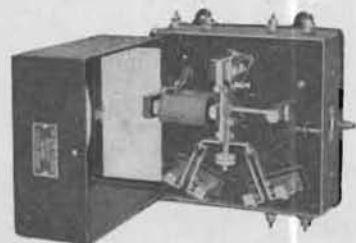

Open View

Code No.	Description
62A	An electrically operated interrupter for furnishing alternating current for Railway Telephone Service from a direct current source. Especially adapted for use in block towers, on yard lines, etc., where several telephones are connected to the same line. Operates on five cells of dry battery and only when battery key is closed.
84H	An electrically operated automatic pole changer producing alternating current from a source of direct electromotive force for ringing purposes. Operates on one Edison Type S No. 502 Cell. Ringing battery varies according to line conditions.
84J	Same as 84H excepting that it will give pulsating currents. Ringing battery varies according to line conditions.
6000A	A circuit interrupter attachment used in the No. 1017E Test Set. The attachment is associated with the generator to provide high frequency ringing current for signalling on composite lines and consists of: <ul style="list-style-type: none"> 1—Commutator with bracket and mounting screw 1—Switch with mounting screws 1—No. 21K Condenser with mounting strap and screws 1—No. 3 Binding Post with mounting screws 1—8-inch standard wire transposition lead 1—Diagram of connection
P-101495	High frequency interrupter used with No. 5 Induction Coil for signalling on composite circuits. Furnished with Nos. 1312A, 1314A and 6023A Telephone Sets.

RAILWAY TRAIN DISPATCHING TELEPHONE SYSTEMS JACKS

Singly Mounted—Welded Frame Jacks

The following singly mounted, electrically welded frame type jacks replace the corresponding punched frame types as indicated in the code number listings. The terminals of the jacks are regularly arranged to accommodate two No. 19 B & S gauge wires unless otherwise specified. Mounting screws are furnished.

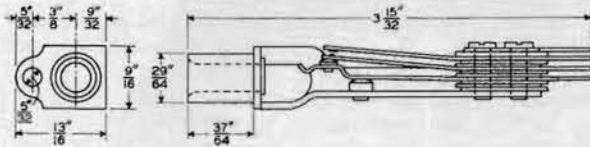

Fig. 1

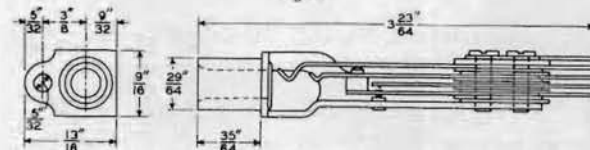

Fig. 2

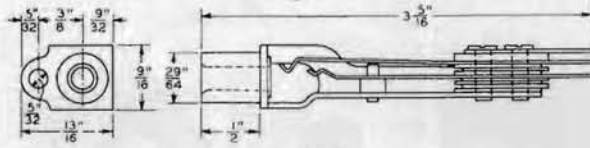

Fig. 3

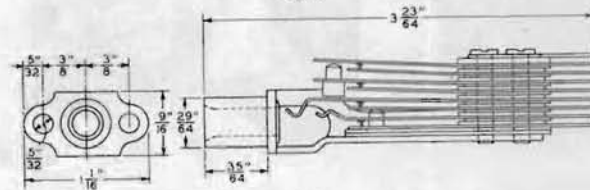

Fig. 4



No. 215 Jack

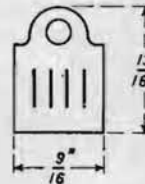

Fig. A

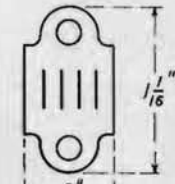
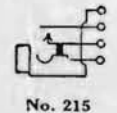
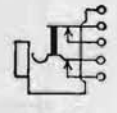

Fig. B



No. 215



No. 216

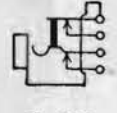

No. 217
220, 235

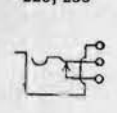

No. 218
219, 231

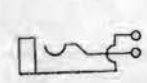

No. 221



No. 225
No. 234



No. 226



No. 227

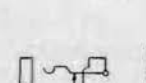

No. 230, 233



No. 232



No. 236



No. 237

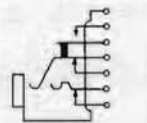

No. 240

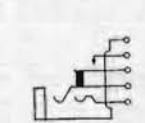

No. 241

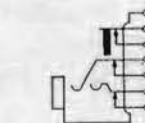

No. 242

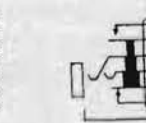

No. 243

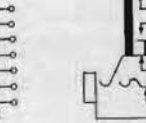

No. 245

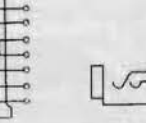

No. 246, 238



No. 248, 239

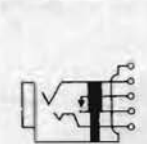

No. 249

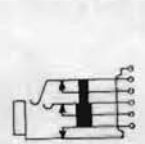

No. 267

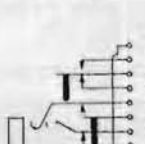

No. 280

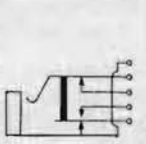

No. 281



No. 284

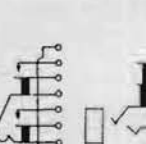

No. 285

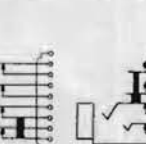

No. 289



No. 290



No. 291

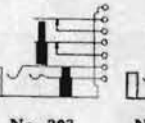

No. 293

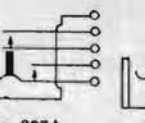

No. 297A

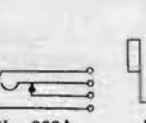

No. 300A

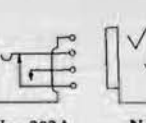

No. 303A

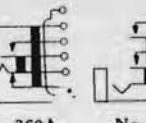

No. 360A

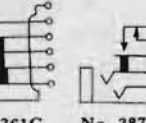

No. 361C

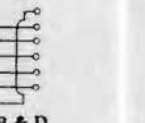

No. 387B & D

RAILWAY TRAIN DISPATCHING TELEPHONE SYSTEMS

Singly Mounted - Welded Frame Jacks (Continued)

Code letters A, B, C and D of the code numbers of jacks listed below indicate the number of mounting lugs (single or double) and their arrangement with respect to the plane of the springs (horizontal or vertical) as illustrated in figures A, B, C and D on the preceding page.

JACKS FOR USE WITH PLUGS Nos. 47, 116, 137, 144, 151, 153D, 154, 217, 220, 221, 241 AND 246

Code No.	Dimen- sions Page 54 Fig. No.	Mounting Centers, Inches		Re- places Jack No.	Code No.	Dimen- sions Page 54 Fig. No.	Mounting Centers, Inches		Re- places Jack No.
		Horizontal	Vertical				Horizontal	Vertical	
(a) 215A	1	5/8	7/8	215	(h) 227C	2	5/8	*	206
(a) 215B	1	5/8	1 1/8	...	(j) 230A	1	5/8	7/8	...
(a) 215C	1	7/8	5/8	...	(j) 230C	1	7/8	5/8	146
(b) 216A	1	5/8	7/8	216	(j) 231A	1	5/8	7/8	...
(b) 216B	1	5/8	1 1/8	...	(j) 231B	1	5/8	1 1/8	...
(b) 216C	1	7/8	5/8	204	(j) 231C	1	7/8	5/8	147
(b) 217A	1	5/8	7/8	217	(j) 231D	1	1 1/8	5/8	168
(b) 217C	1	7/8	5/8	209	232A	1	5/8	7/8	...
(c) (b) 217E	1	5/8	7/8	...	232B	1	5/8	1 1/8	...
218A	1	5/8	7/8	218	232C	1	7/8	5/8	148
218B	1	5/8	1 1/8	...	232D	1	1 1/8	5/8	169
218C	1	7/8	5/8	...	(k) 232E	1	5/8	7/8	...
(d) 218E	1	5/8	7/8	...	233A	1	5/8	7/8	...
219A	1	5/8	7/8	219	233B	1	5/8	1 1/8	...
219B	1	5/8	1 1/8	...	233C	1	7/8	5/8	149
219C	1	7/8	5/8	155	233D	1	1 1/8	5/8	170
219D	1	1 1/8	5/8	175	(L) 234A	1	7/8	5/8	...
220A	1	5/8	7/8	220	(L) 234C	1	7/8	5/8	151
220C	1	7/8	5/8	154	(L) 234D	1	1 1/8	5/8	172
220D	1	1 1/8	5/8	176	(j) 235A	1	5/8	7/8	...
221A	1	5/8	7/8	221	(j) 235C	1	7/8	5/8	153
221B	1	5/8	1 1/8	...	(j) 235D	1	1 1/8	5/8	174
221C	1	7/8	5/8	152	236A	1	23/32	7/8	...
221D	1	1 1/8	5/8	173	(m) 236B	1	23/32	1 1/8	...
(e) 223A	1	5/8	7/8	223	236C	1	7/8	5/8	189
(e) 223B	1	5/8	1 1/8	...	236D	1	1 1/8	5/8	188
(f) 225A	1	5/8	*	225	237A	1	5/8	5/8	...
(f) 225B	1	5/8	1 1/8	...	237C	1	7/8	5/8	185
(f) 225C	1	5/8	*	156	(n) 281A	2	5/8	7/8	...
(f) 225D	1	5/8	1 1/8	177	(n) 297A	1	5/8	7/8	...
(g) (f) 225E	1	5/8	*	229A	303A	1	5/8	7/8	...
(a) 226A	1	5/8	*	226	(o) 303AK	1	5/8	7/8	...
(a) 226C	1	5/8	*	...	361C	1	7/8	5/8	...
(h) 227A	2	5/8	*	227					

- (*) Vertical center 5/8" when mounted in double horizontal rows with lugs in opposite directions and 7/8" when mounted in double horizontal rows with lugs in the same direction.
- (a) The terminal of the tip springs is arranged to accommodate two No. 16 B & S gauge wires.
- (b) The terminal of the tip spring and the terminal of the spring which makes contact with it are arranged to accommodate two No. 16 B & S gauge wires.
- (c) Same as No. 217A Jack except it has a nickel-silver sleeve.
- (d) Same as the No. 218A Jack except equipped with platinum contacts.
- (e) Same as the No. 221 type except the terminal of the tip spring is arranged to accommodate two No. 16 B & S gauge wires.
- (f) The terminals of all springs are arranged to accommodate two No. 16 B & S gauge wires.
- (g) Same as the No. 225A Jack except equipped with platinum contacts.
- (h) The terminals of the tip and ring springs are arranged to accommodate two No. 16 B & S gauge wires.
- (j) Local contacts not designed for use in talking circuits.
- (k) The same as the No. 232A Jack except equipped with platinum contacts.
- (L) Normally closed contacts are not designed for use in talking circuits.
- (m) Cannot be used with Nos. 137, 152, 154, 209, 217, 218, 220, 241, 246 and 249 Plugs.
- (n) Heavily insulated jacks.
- (o) Same as No. 303A Jack except equipped with platinum contacts.

RAILWAY TRAIN DISPATCHING TELEPHONE SYSTEMS

Singly Mounted—Welded Frame Jacks (Continued)

JACKS FOR USE WITH No. 109 TYPE PLUG

Code No.	Dimensions Page 54 Fig. No.	—Mounting Centers, Inches—		Replaces Jack No.
		Horizontal	Vertical	
246A	3	$\frac{5}{8}$	$\frac{7}{8}$	126
246B	3	$\frac{5}{8}$	$1\frac{1}{8}$...
(a) 246E	3	$\frac{5}{8}$	$\frac{7}{8}$...
248A	3	$\frac{5}{8}$	$\frac{7}{8}$	134
248B	3	$\frac{5}{8}$	$1\frac{1}{8}$...
248D	3	$1\frac{1}{8}$	$\frac{5}{8}$...
(b) 248E	3	$\frac{5}{8}$	$\frac{7}{8}$...
249A	3	$\frac{5}{8}$	$\frac{7}{8}$	143
249B	3	$\frac{5}{8}$	$1\frac{1}{8}$...

(a) Same as the No. 246A Jack except equipped with nickel-silver sleeve.

(b) Same as the No. 248A Jack except equipped with nickel-silver sleeve.

JACKS FOR USE WITH Nos. 110, 150, 184, 202 AND 213 TYPE PLUGS

Code No.	Dimen- sions Page 54 Fig. No.	Mounting Centers, Inches		Re- places Jack No.	Code No.	Dimen- sions Page 54 Fig. No.	Mounting Centers, Inches		Re- places Jack No.
		Horizontal	Vertical				Horizontal	Vertical	
238A	2	$\frac{5}{8}$	$\frac{7}{8}$	159	243B	2	$\frac{3}{4}$	$1\frac{1}{8}$	184
238B	2	$\frac{5}{8}$	$1\frac{1}{8}$	178	245A	2	$\frac{29}{32}$	$\frac{7}{8}$...
238C	2	$\frac{7}{8}$	$\frac{5}{8}$	274	245B	2	$\frac{29}{32}$	$1\frac{1}{8}$...
238D	2	$1\frac{1}{8}$	$\frac{5}{8}$...	245C	2	$\frac{29}{32}$	$\frac{5}{8}$...
(a) 238E	2	$\frac{5}{8}$	$1\frac{1}{8}$...	(d) 267A	2	$1\frac{1}{16}$	$\frac{5}{8}$...
239A	2	$\frac{5}{8}$	$\frac{7}{8}$	160	280A	2	$\frac{7}{8}$	$\frac{7}{8}$...
239B	2	$\frac{5}{8}$	$1\frac{1}{8}$	179	280B	2	$\frac{7}{8}$	$1\frac{1}{8}$...
239C	2	$\frac{7}{8}$	$\frac{5}{8}$	260	280C	2	$\frac{7}{8}$	$\frac{5}{8}$...
239D	2	$1\frac{1}{8}$	$\frac{5}{8}$...	284A	2	1	$\frac{7}{8}$...
(b) 239E	2	$\frac{5}{8}$	$\frac{7}{8}$...	284B	2	1	$1\frac{1}{8}$...
240A	2	$\frac{3}{4}$	$\frac{7}{8}$	161	285A	2	$1\frac{3}{16}$	$\frac{7}{8}$...
240B	2	$\frac{3}{4}$	$1\frac{1}{8}$	180	285B	2	$1\frac{3}{16}$	$1\frac{1}{8}$...
240C	2	$\frac{7}{8}$	$\frac{5}{8}$...	285C	2	$\frac{7}{8}$	$\frac{5}{8}$...
241A	2	$\frac{3}{4}$	$\frac{7}{8}$	162	289B	4	$1\frac{3}{16}$	$1\frac{1}{8}$...
241B	2	$\frac{3}{4}$	$1\frac{1}{8}$	181	290B	4	$1\frac{5}{16}$	$1\frac{1}{8}$...
241C	2	$\frac{7}{8}$	$\frac{5}{8}$...	291B	2	1	$1\frac{1}{8}$...
241D	2	$1\frac{1}{8}$	$\frac{5}{8}$...	293B	2	$1\frac{5}{16}$	$1\frac{1}{8}$...
242A	2	$\frac{3}{4}$	$\frac{7}{8}$	163	300A	2	$\frac{5}{8}$	$\frac{7}{8}$	282
242B	2	$\frac{3}{4}$	$1\frac{1}{8}$	182	360A	2	$\frac{29}{32}$	$\frac{7}{8}$...
242C	2	$\frac{7}{8}$	$\frac{5}{8}$	259	387B	2	$1\frac{3}{16}$	$1\frac{1}{8}$...
(c) 242CK	2	$\frac{7}{8}$	$\frac{5}{8}$...	387D	2	$1\frac{1}{8}$	$\frac{5}{8}$...
243A	2	$\frac{3}{4}$	$\frac{7}{8}$	165					

(a) Same as the No. 238B except equipped with a nickel-silver sleeve.

(b) Same as the No. 239A except equipped with a nickel-silver sleeve.

(c) Equipped with platinum contacts.

(d) Heavily insulated jack.

RAILWAY TRAIN DISPATCHING TELEPHONE SYSTEMS

Jacks (Continued)

Singly Mounted—Miscellaneous Types

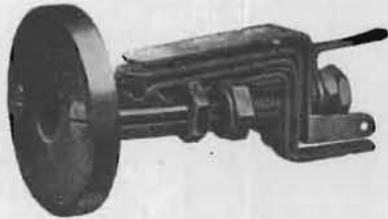

No. 77 Jack



No. 389A-3 Jack



No. 77

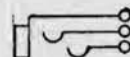

No. 78



No. 389A-3

Code No.

Description

- 77 Operator's telephone set. Makes one separate contact when a No. 148 Plug is inserted; has tip, ring and sleeve terminals.
- 78 Same as No. 77 Jack, except that the make contact is omitted. Diameter of mounting plate $1\frac{1}{16}$ inches.
- 389A-3 This jack is intended for use in locations where it is desirable to move a desk stand from place to place. The No. 273A-3 Plug is used with this jack; it is provided with tip, ring and sleeve connections. The cover is $1\frac{1}{16}$ inches square and 1 inch deep, and is finished black. The base and cover are slotted to allow wires to be brought in from wire moulding.



No. 200 Jack

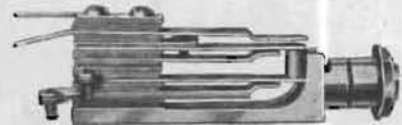

No. 224 Jack

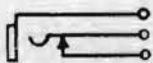

No. 200

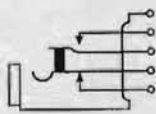

No. 203

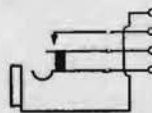

No. 208

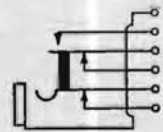

No. 224

The Nos. 200, 203, 208 and 224 are fibre insulated jacks having micanite bushings. They will mount on any thickness of wood from $\frac{3}{4}$ to $\frac{7}{8}$ inch, the jack shank being threaded and the jack held in place by means of a nickel finished nut.

Code No.	Mounting Centers, Inches		Used with Plugs	Used in Jack Boxes
	Horizontal	Vertical		
200	$1\frac{5}{16}$	1	1A, 47 & 116
203	$1\frac{5}{16}$	$1\frac{1}{4}$	1A, 47 & 116
208	$1\frac{5}{16}$	$1\frac{3}{8}$	1A, 47 & 116	385, 386 & 389
224	$1\frac{5}{16}$	$1\frac{1}{2}$	1A, 47 & 116	385, 386 & 389

RAILWAY TRAIN DISPATCHING TELEPHONE SYSTEMS

Dispatcher's Station

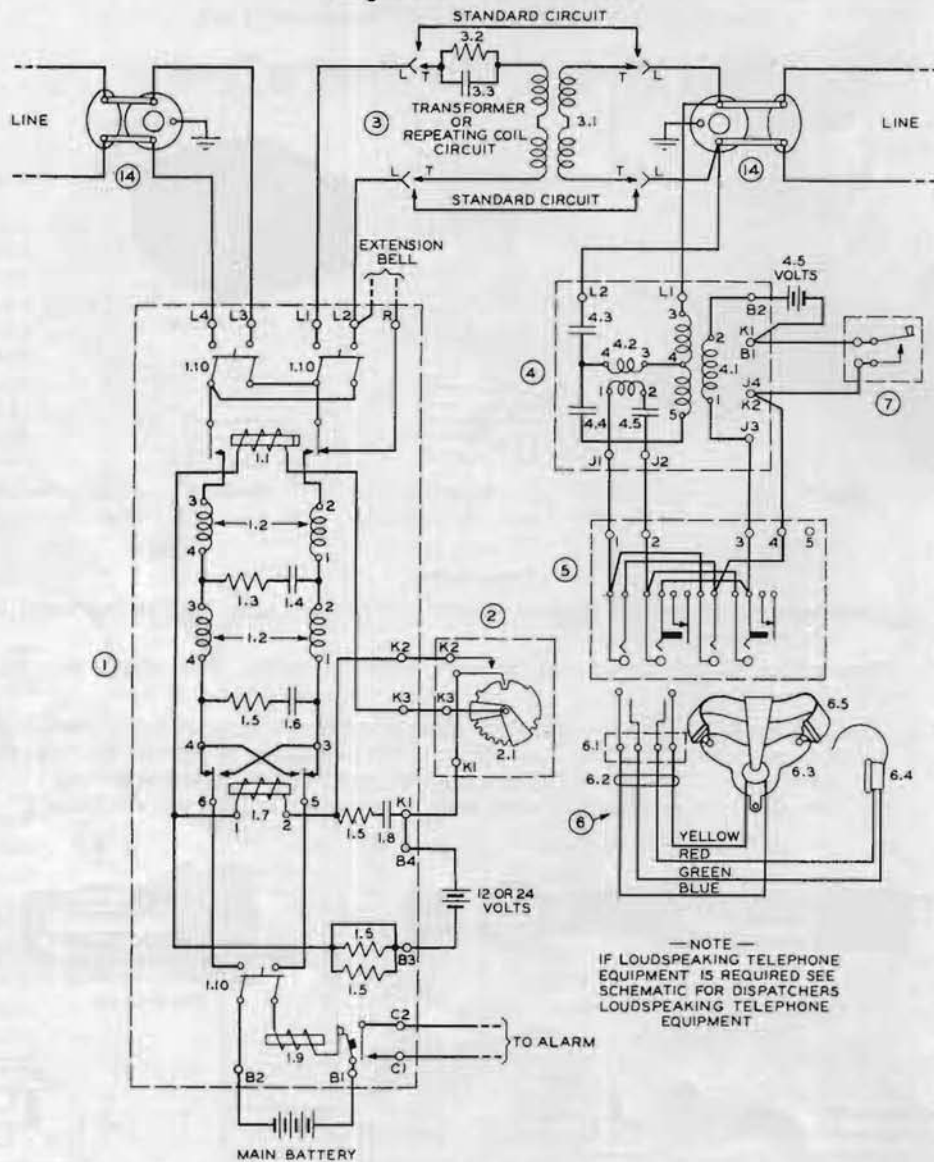

1. No. 160B Selector Apparatus Case
 - 1.1 No. 221JB Relay
 - 1.2 No. 152A Retardation Coil
 - 1.3 No. 63F Resistance
 - 1.4 No. 138B Condensers (4)
 - 1.5 No. 63C Resistance
 - 1.6 No. 138A Condenser
 - 1.7 No. 26A Telegraph Relay
 - 1.8 No. 141A Condenser
 - 1.9 No. 2B Circuit Breaker
 - 1.10 No. 709 Trumbull Switch DPST
2. Nos. 60A, B, C, D or E Selector Key Cases
 - 2.1 Nos. 60A or B Selector Keys and

- No. 50A Selector Key Spaces, or Nos. 61A or B Selector Key, or Nos. 62A or B Selector Key, or Nos. 63A or B Selector Key
3. Use when Transformer Circuit is required by connecting the "T" Leads to the "L" Leads
 - 3.1 No. 341 Transformer or No. 70A Repeating Coil
 - 3.2 DM-2000 Ward Leonard Resistance
 - 3.3 No. 160B Condensers or No. 138B Condensers as required
4. No. 502A Desk Set Box
 - 4.1 No. 43 Induction Coil

- 4.2 No. 44 Induction Coil
- 4.3 No. 140B Condenser
- 4.4 No. 141B Condenser
- 4.5 No. 141A Condenser
5. No. 345A Jack Box
6. Dispatcher Head Telephone Set
 - 6.1 No. 137 Plug
 - 6.2 No. 565 Cord
 - 6.3 No. 386 Transmitter
 - 6.4 No. 189 Receiver
 - 6.5 No. 3A Transmitter Attachment
7. No. 6000A Key or No. 1B Foot Switch

RAILWAY TRAIN DISPATCHING TELEPHONE SYSTEMS Way Station

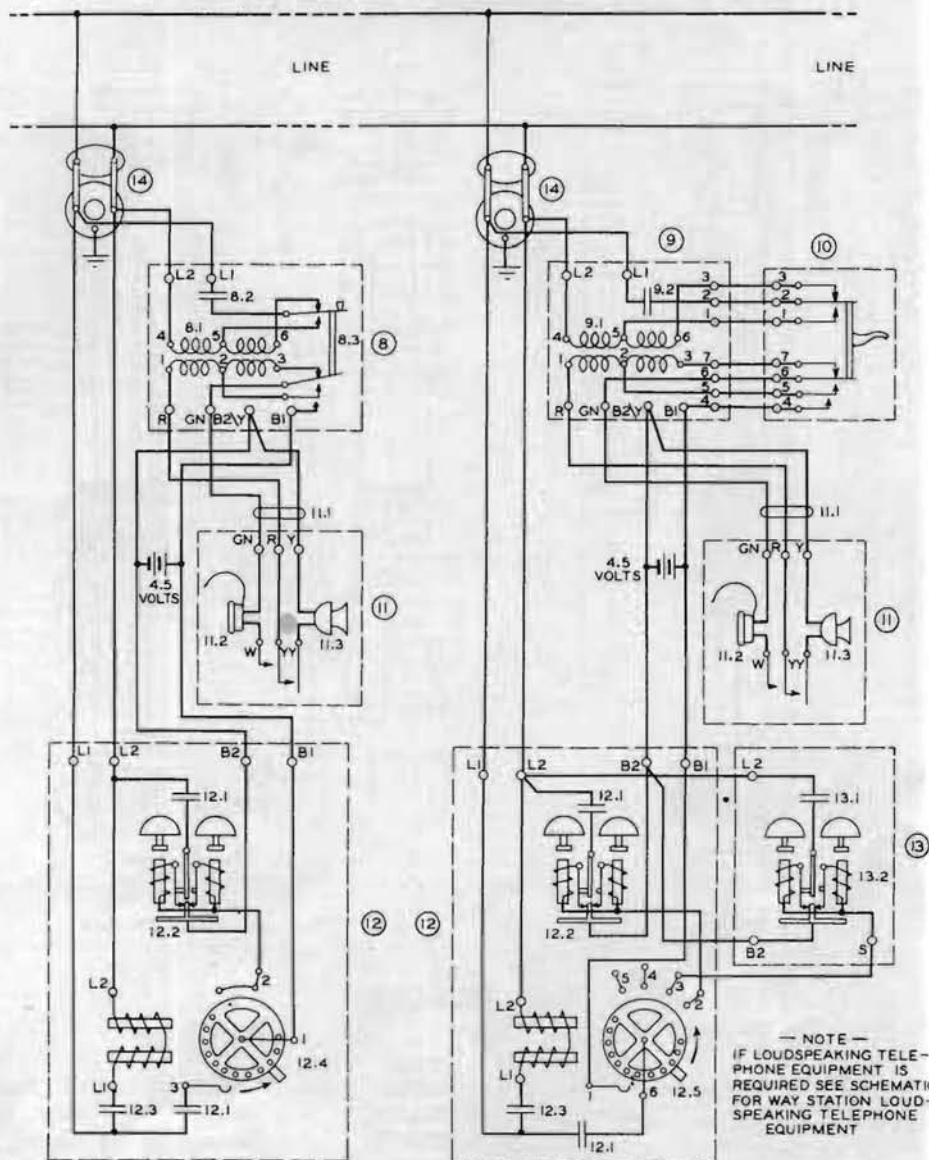

- | | |
|--|--|
| <p>8. No. 501A Desk Set Box
 8.1 No. 42 Induction Coil
 8.2 No. 142B Condenser
 8.3 No. 1014A Push Button</p> <p>9. No. 501B Desk Set Box
 9.1 No. 42 Induction Coil
 9.2 No. 142B Condenser</p> <p>10. No. 3C Foot Switch</p> <p>11. No. 1142AB Desk Stand
 11.1 No. D3H-9 Cord
 11.2 No. 189 Receiver
 11.3 No. 349 Transmitter</p> <p>12. No. 160C Selector Set or
 No. 160R Selector Set</p> | <p>12.1 No. 141H Condenser (1/2)
 12.2 No. 60CG Ringer
 12.3 No. 138B Condenser
 12.4 No. 60AP Selector*
 12.5 No. 60BP Selector*
 * Not part of set.</p> <p>13. No. 127J Extension Bell
 13.1 No. 21BA Condenser
 13.2 No. 60CG Ringer</p> <p>14. No. 58BP Protector consisting of
 1—No. 29B Protector Mounting
 1—No. 16 Protector Mounting
 1—No. 48 Protector Mounting
 2—No. 26 Protector Blocks
 2—No. 30 Protector Blocks
 2—No. 11C Fuses—7 amperes</p> |
|--|--|

RAILWAY TRAIN DISPATCHING TELEPHONE SYSTEMS

Singly Mounted—Miscellaneous Type Jacks (Continued)

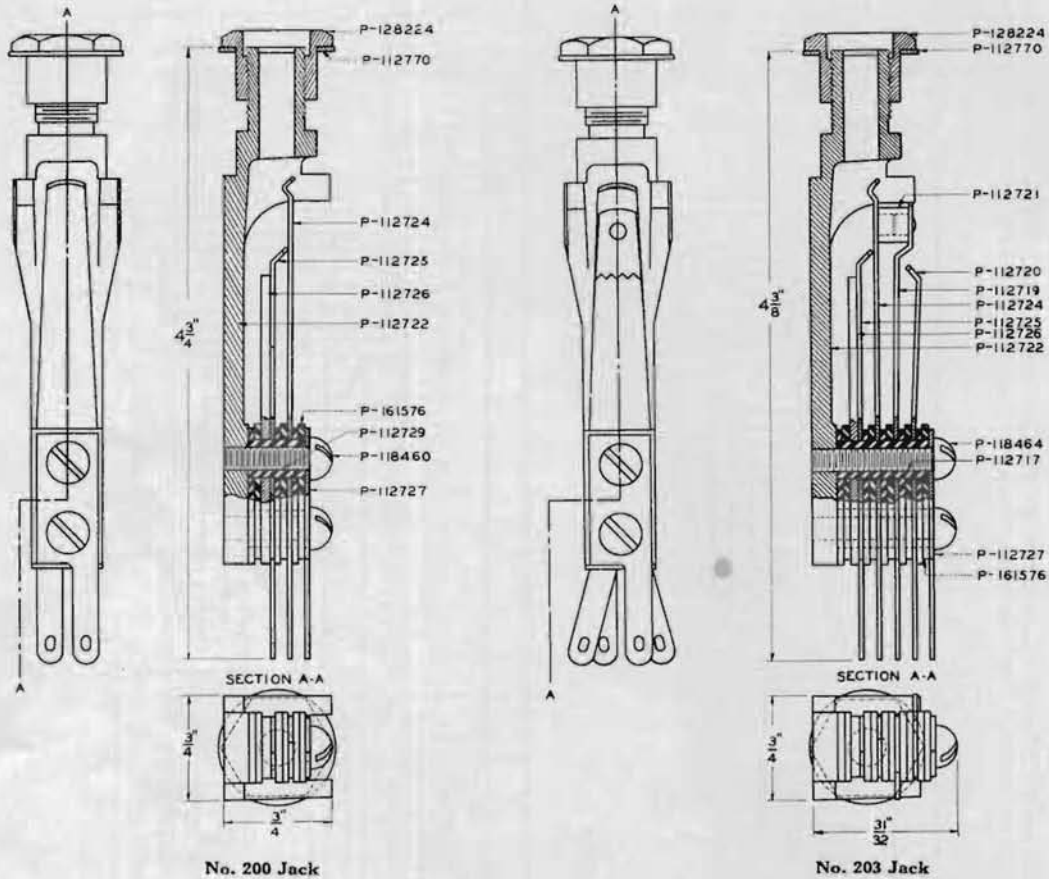

Replacement Parts

No. 200 Jack				No. 203 Jack			
Piece Part No.	No. Req.	Material	Name	Piece Part No.	No. Req.	Material	Name
P128224	1	Brass	Sleeve Nut	P128224	1	Brass	Sleeve Nut
P112770	1	Brass	Washer	P112770	1	Brass	Washer
P112724	1	Ger. Silver	Tip Spring	P112721	1	Micanite	Bushing
P112725	1	Ger. Silver	Contact Spring	P112720	1	Ger. Silver	Contact Spring
P112726	1	Brass	Stop Spring	P112719	1		Contact Spring & Stud
P112722	1	Brass	Frame	P112724	1	Ger. Silver	Tip Spring
P161576	6 & As Req.	Phenol Fibre	Insulator	P112725	1	Ger. Silver	Contact Spring
P112729	2	Micanite	Bushing	P112726	1	Brass	Stop Spring
P118460	2	Brass	R.H.M. Screw	P112722	1	Brass	Frame
P112727	1	Ger. Silver	Terminal	P118464	2	Brass	R.H.M. Screw
				P112717	2	Micanite	Bushing
				P112727	1	Ger. Silver	Terminal
				P161576	10 & As Req.	Phenol Fibre	Insulator

RAILWAY TRAIN DISPATCHING TELEPHONE SYSTEMS

Singly Mounted—Miscellaneous Type Jacks (Continued)

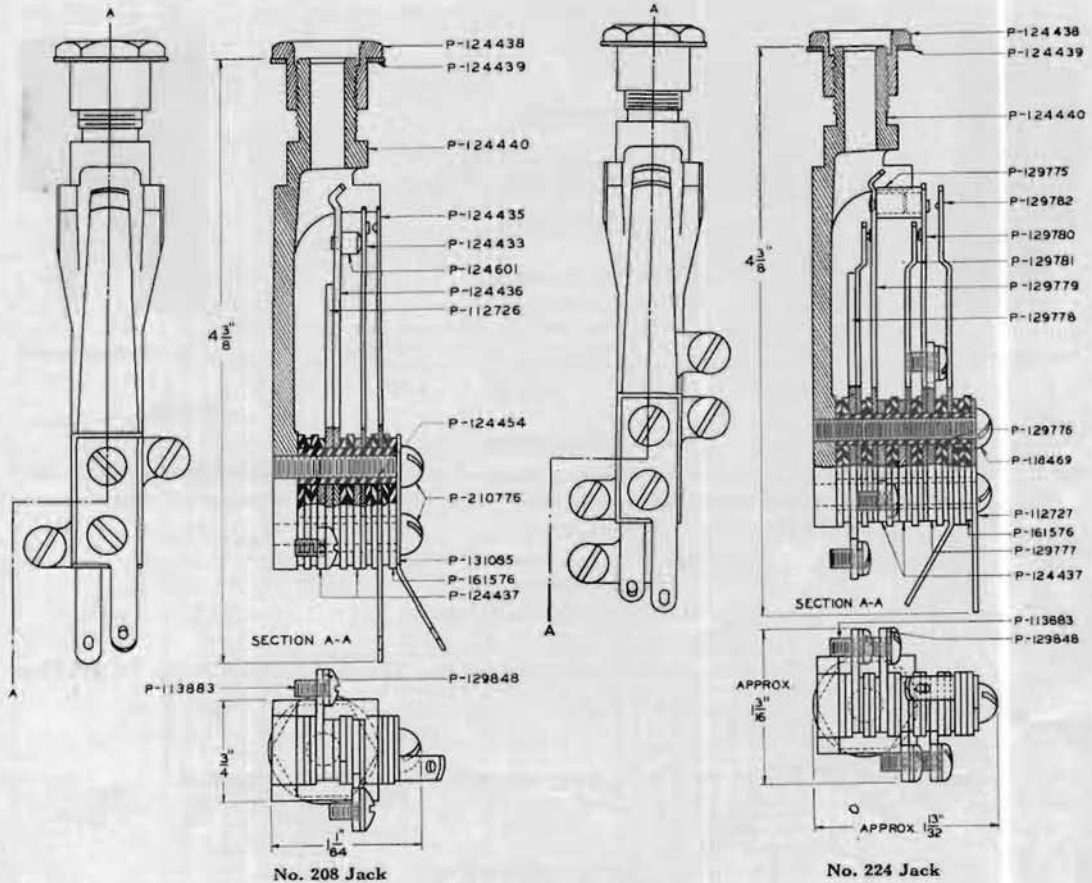

Replacement Parts

No. 208 Jack				No. 224 Jack			
Piece Part No.	No. Req.	Material	Name	Piece Part No.	No. Req.	Material	Name
P124438	1	Brass	Sleeve Nut	P124438	1	Brass	Sleeve Nut
P124439	1	Brass	Washer	P124439	1	Brass	Washer
P124440	1	Brass	Frame	P124440	1	Brass	Frame
P124435	1		Contact Spring	P129775	1	Micanite	Bushing
P124433	1		Contact Spring				(Separator)
P124601	1	Hd. Rubber	Separator	P129782	1		Contact Spring
P124436	1	Nickel Silver	Tip Spring	P129780	1		Contact Spring
P112726	1	Brass	Stop Spring	P129781	2		Contact Spring
P124454	2	Micanite	Bushing	P129779	1		Tip Spring
P210776	2	Steel	R.H.M. Screw	P129778	1	Brass	Terminal
P131035	1	Nickel Silver	Terminal	P129776	2	Micanite	Bushing
P161576	9 &	Phenol Fibre	Insulator	P118469	2	Brass	R.H.M. Screw
	As Req.			P112727	1	Ger. Silver	Terminal
P124437	2	Brass	Terminal	P161576	13	Phenol Fibre	Insulator
P129848	2	Brass	Washer	P129777	1	Brass	Terminal
P113883	2	Brass	Button H.M. Screw	P124437	2	Brass	Terminal
				P113883	4	Brass	Button H.M. Screw
				P129848	4	Brass	Washer

RAILWAY TRAIN DISPATCHING TELEPHONE SYSTEMS

Singly Mounted—Miscellaneous Type Jacks (Continued)

No. 186 Jack

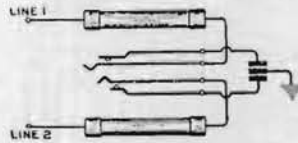

No. 186 Jack Wiring



No. 186 Jack (open)

**Code
No.****Description**

- 186** A jack designed for mounting on poles as a means of connecting a portable telephone to the line. Has a cast frame and cover; black rust-proof finish. The plug hole is protected against insects by covering with spring flap; equipped with:
- Two 500 volt, 1 ampere, Gem fuses
 - Two No. 1 Protector Blocks
 - Two No. 2 Protector Blocks
 - Two No. 3 Protector Micas
- A lock will be supplied when specified as a separate item. This jack is used with the No. 146 Plug.
- 187** Same as No. 186 Jack except that it is not equipped with protective apparatus.

JACK BOXES**No. 60A JACK BOX**

The No. 60A Jack Box, as shown above, equipped with ten No. 60A or No. 60D Combined Jack and Signals is for use at way stations where it is desired to connect a single telephone set to one of several telephone lines. Incoming calls are indicated visually by means of drop signals and also, if desired, announced audibly by a buzzer.

RAILWAY TRAIN DISPATCHING TELEPHONE SYSTEMS

Jack Boxes (Continued)

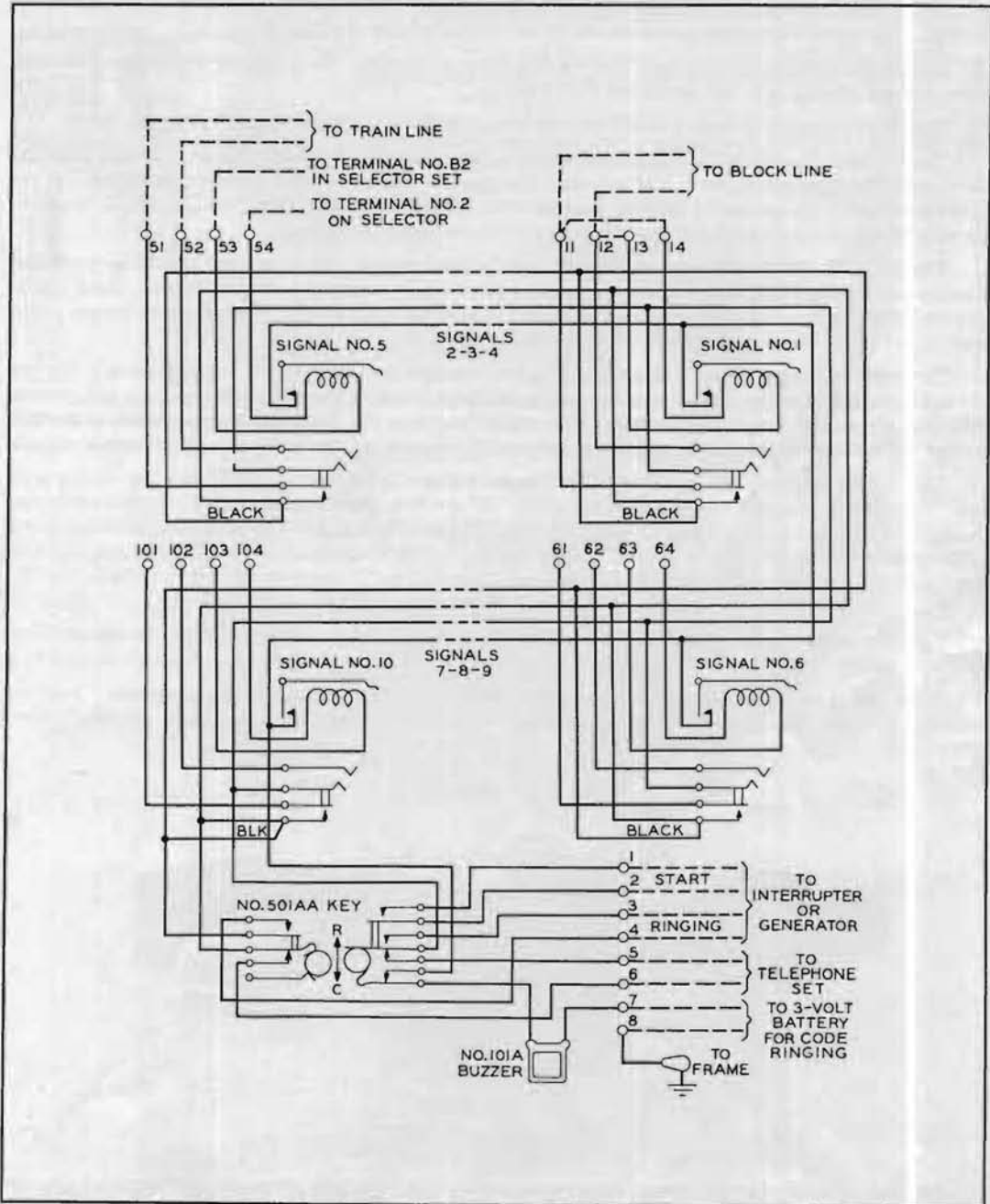

Schematic of No. 60A Jack Box

RAILWAY TRAIN DISPATCHING TELEPHONE SYSTEMS*No. 60A Jack Box (Continued)*

The operator's telephone set is put into circuit by inserting a plug into the jack indicated by the fallen shutter. The signal is restored automatically to its original position by this operation.

In addition to the combined jack and signals, the jack box contains a ringing key, buzzer, terminal plate, and a solid plug attached to the box by a cord.

The cabinet is made of brass finished in black and is 10" long, 7½" high, and 7½" deep.

The No. 60A Combined Jack and Signals have a low resistance of 82 ohms for use on train lines and the signals should be connected in multiple with the ringer in the selector set as shown for Signal 5 of the above schematic. Whenever the selector is operated to its local ringing position, the No. 60CG Ringer in the selector set and the associated signal in the jack box will both be operated.

The No. 60D Combined Jack and Signals have a resistance of 1000 ohms and should be connected directly to a local or block line as shown for Signal 1 in the above schematic. In this case the signal will be operated directly by a hand generator or a ringing interrupter over the line wires and the buzzer in the local circuit of the signal contact will follow the code ringing.

The winding of each signal is brought out to two separate terminals on the terminal plate in the top of the box so that the signals may be connected to the local circuit of the selector sets on train and message lines that are part of the phantom circuit. The connections from the train and message wires to the jack springs are open when the plug is not in the jack and thus cause no interference on the phantom circuits.

The ringing key has three positions. The normal position is for incoming calls and the talking position. When the key handle is operated down to the "R" position, the outgoing ringing circuit is completed through the jack springs of the jack in which the plug is inserted to the corresponding line. Also the circuit to the operator's telephone set is opened. When the key handle is operated to the "C" position, the code ringing circuit to the buzzer is opened. The key is locking in the "C" position and non-locking in the "R" position.

Provision is made in the wiring so that on lines, where ringing is not desired, this may be accomplished by disconnecting the black wires from the bottom terminal in the jack spring pileup associated with that line.

When less than full capacity of ten combined jacks and signals is required, the unequipped positions are fitted with No. 70A Apparatus Blanks. However, in all cases, the jack box is furnished completely wired for ten combined jacks and signals.



No. 345A Jack Box



No. 385A Jack Box

NO. 345A JACK BOX

Oak box primarily for use in train dispatching circuits at dispatcher's office and is so arranged that two headsets can be connected to the line at the same time.

Equipped with one No. 30 Jack Mounting, two No. 237C Jacks and two No. 221C Jacks.

Approximate dimensions, length 5½", width 4¾", height 2".

RAILWAY TRAIN DISPATCHING TELEPHONE SYSTEMS

Jack Boxes (Continued)

Cordless Jack Boxes

Oak boxes with nickel trimming for miscellaneous purposes. Each box is equipped with hinge cover and a No. 1A Plug attached by means of a dummy cord. The No. 389 Type is split and hinged on a line midway between the upper and lower jack levels.

Telephone Jack Boxes Nos. 385A, B, 386A, B, C, and 389A are so arranged that one telephone line can be terminated in each jack. A telephone set can be connected to any of these lines by inserting the plug in the proper jack.

Telegraph Jack Boxes Nos. 385C, D, 386D, E, F, and 389B are so arranged that one telegraph line can be looped through each jack. Resonator set can be connected to any of these lines by inserting the plug in the proper jack. When this is done, the calling set is disconnected.

Code No.	Line Equipment	Capacity	Equipped with Jacks	Service	Dimensions, Inches		
					Width	Height	Depth
*385A	2	3	208	Telephone	4 1/2	2 3/4	6 1/4
385B	3	3	208	Telephone	4 1/2	2 3/4	6 1/4
*385C	2	3	224	Telegraph	4 1/2	2 3/4	6 1/4
385D	3	3	224	Telegraph	4 1/2	2 3/4	6 1/4
*386A	4	6	208	Telephone	7 3/8	2 3/4	6 1/4
*386B	5	6	208	Telephone	7 3/8	2 3/4	6 1/4
386C	6	6	208	Telephone	7 3/8	2 3/4	6 1/4
*386D	4	6	224	Telegraph	7 3/8	2 3/4	6 1/4
386E	5	6	224	Telegraph	7 3/8	2 3/4	6 1/4
386F	6	6	224	Telegraph	7 3/8	2 3/4	6 1/4
389A	12	12	208	Telephone	7 3/8	4 5/8	6 1/4
389B	12	12	224	Telegraph	7 3/8	4 5/8	6 1/4

*No. 17C Apparatus Blank, illustrated in the center jack position on the cut of the No. 385A Jack Box, is furnished in all unequipped positions.

Combined Jacks and Signals

SHUTTER TYPE

No. 22-C COMBINED JACKS & SIGNALS

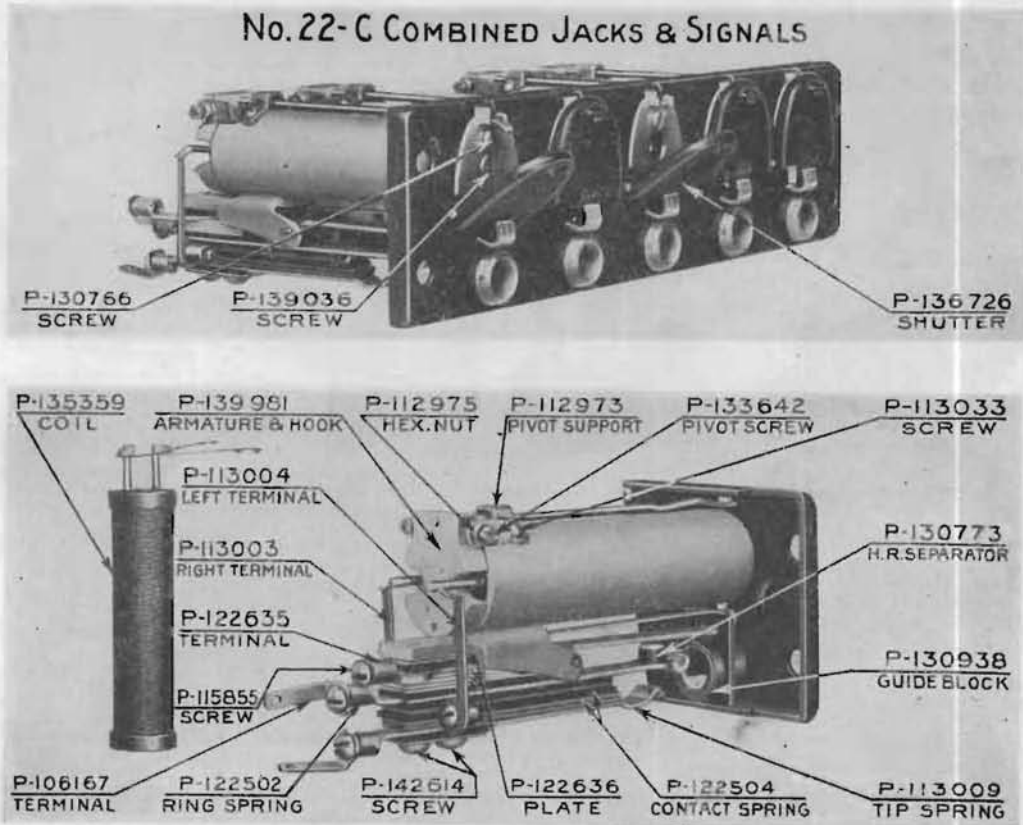

RAILWAY TRAIN DISPATCHING TELEPHONE SYSTEMS

Combined Jacks and Signals (Continued)

Code No.	Resistance	Mounting	Used With
22C	350	Single or 5 per strip.	Special jack boxes.
60A	82	Single or 5 per strip.	No. 60A jack box.
60D	1000	Single or 5 per strip.	No. 60A jack box.

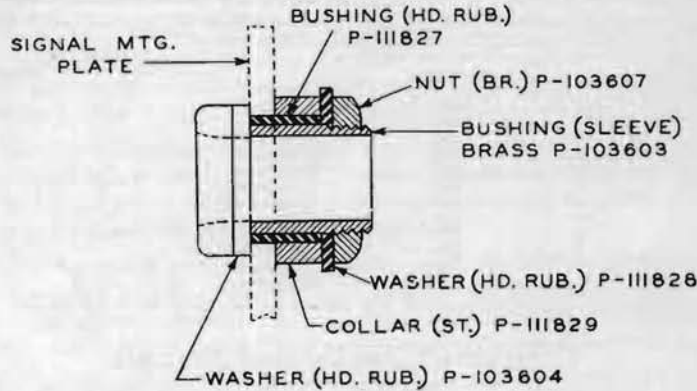

Replacing Jack Sleeve for
Combined Jacks and Signals

The above illustration outlines the parts necessary for replacing the sleeve assembly of the Combined Jacks and Signals.

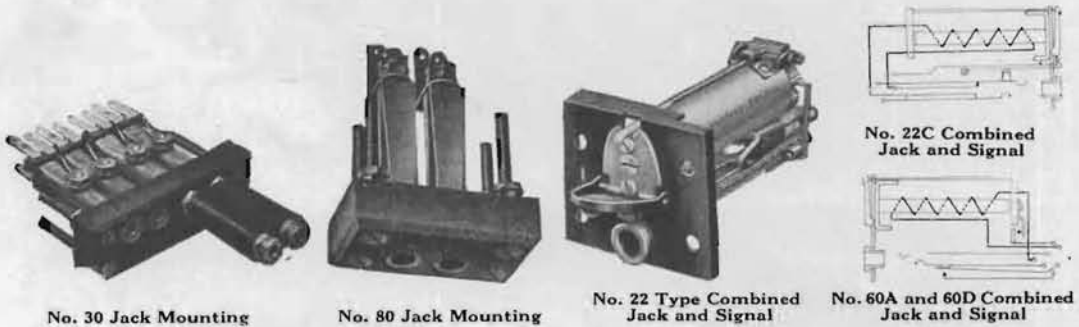

Jack Mountings

Code No.	Description	Dimensions, Inches	Used With
30	Composition mounting for 4 Nos. 99, 185, 220, 221 or 234 Jacks.	$3\frac{3}{4} \times 1\frac{1}{4} \times \frac{5}{8}$	Dispatcher's telephone equipment. In No. 345A Jack Box.
80	Composition mounting for 2 Nos. 99, 185, 220, 221 or 234 Jacks.	$2\frac{3}{8} \times 1\frac{1}{4} \times \frac{5}{8}$	Head Telephone Sets with No. 137 Plug

RAILWAY TRAIN DISPATCHING TELEPHONE SYSTEMS

KEYS



No. 378A Key



No. 92B Key

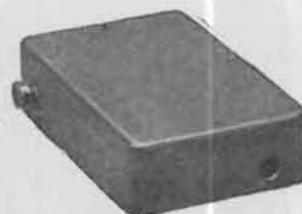

No. 465 Type Key

Code No.	Description	Used
92A	Single mounted push button key. Non-locking. For $\frac{7}{8}$ or $1\frac{1}{4}$ inch shelf. Makes two and breaks two contacts.	As a ringing key.
92B	Same as No. 92A except that it is a locking key.	As a listening key.
136B	A horizontal switching key with two sets of springs. Locks in both positions.	To connect one telephone to any one of three lines. Part of the No. 6000B Key.
272A	Single mounted locking key. Makes two and breaks two contacts. Key is operated by a turning movement of button. For $\frac{7}{8}$ and $1\frac{1}{4}$ inch shelf.	In Nos. 1A and 1B test boards.
375A	Push button ringing key; makes two and breaks two contacts and is non-locking.	As part of the No. 6002C Key.
377A*	Plunger type key used with key lever. Makes two contacts.	In No. 6000A Key.
378A*	Plunger type key used with key lever. Makes two and breaks two contacts.	Used as a listening key.
392A*	Plunger type key used with key lever. Makes four and breaks four contacts.	In No. 335A Blocking Set.
393C	Non-locking, push button key, makes three contacts, breaks two contacts.	In the No. 6003A Key.
465A	Push button key mounted in an oak box. Makes three and breaks one contact. Dimensions: $4\frac{11}{16} \times 3\frac{1}{16} \times 1\frac{13}{16}$ inches.	In old type way station telephone circuits (non-insulated transmitter) and No. 6023A Telephone Set.
465C	Push button type key mounted in an oak box. Dimensions $4\frac{11}{16} \times 3\frac{1}{16} \times 1\frac{13}{16}$ inches. Makes two and breaks one contact.	In train dispatching circuits for way-station operators to cut in transmitter.
465D	Push button key, similar to the No. 465A, except that it makes one and breaks one contact.	With the No. 1317 Telephone Sets.
465E	Similar to No. 465C, except makes three and breaks two contacts.	In train dispatching circuits for way stations with No. 501B Desk Set Boxes.

Note. When ordering keys Nos. 92A, 92B, or 272A unmounted, specify the thickness of the shelf or table top in which key is to be mounted.

*Are either locking or non-locking, depending on the type of lever used.

RAILWAY TRAIN DISPATCHING TELEPHONE SYSTEMS

Keys (Continued)



No. 6000A Key



No. 6A Key Lever



No. 6000B Key



No. 6017 Type Key

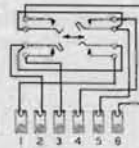

No. 6017A

Circuit Schematics

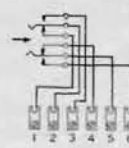

No. 6017B

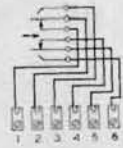

No. 6017C

Code No.	Description	Used
6000A	Plunger type key. No. 377A with No. 6A Key Lever mounted in a box 4 3/4 x 3 3/4 x 1 13/16 ins.	In dispatcher's telephone circuit.
6000B	Consists of No. 136B Key mounted in a No. 334 Key Mounting. Dimensions approximately 6 1/4 x 3 3/8 x 2 11/16 ins.	Where it is desired to connect one telephone set to any one of three separate lines.
6017A	Consists of a 2BF Key Unit and connecting block mounted in a black finished metal box. Dimensions of box 6 1/2 x 3 13/16 x 1 3/8. Spring combination locking.	Intended for use as a switching key to connect a telephone instrument on either one or both of two lines.
6017B	Consists of a 2GP Key Unit and connecting block mounted in a black finished metal box. Dimensions same as 6017A. Spring combination locking.	Intended for use as a switching key to connect a telephone instrument on either one or two lines.
6017C	Consists of a 2F Key Unit and connecting block mounted in a black finished metal box. Dimensions same as 6017A. Spring combination non-locking.	Intended for use as a ringing key at sub-station.

Key Levers

Code No.	Operated Position of Lever	Description
6A	Vertical	Used with lever type keys. Black handle. Locking.
6B	Vertical	Same as No. 6A, except red handle.
14A	Horizontal	Otherwise same as No. 6A.
23A	Horizontal	Switch key. Locks in all positions. Normally all contacts are open. When thrown to the left the inner contacts are closed; when thrown to the right, the outer contacts are closed.

RAILWAY TRAIN DISPATCHING TELEPHONE SYSTEMS
LINE POLES



No. 3 Line Pole



End Section with Spreaders Extended No. 3 Line Pole



Part of End Section with Spreaders Closed No. 3 Line Pole



No. 4 Line Pole



Part of End Section Showing Method of Clamping to Wire No. 4 Line Pole



No. 5 Line Pole

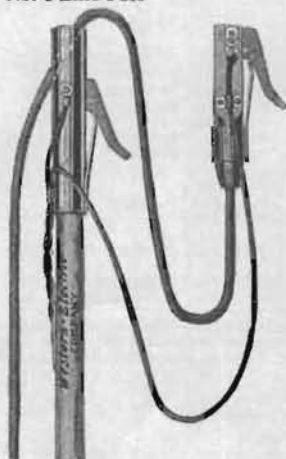

Part of End Section Showing Free Clamp. No.5 Line Pole

Line Poles

The line poles here listed are intended primarily for connecting portable telephones to open wire lines. They are made of hardwood and are in three sections, each approximately 6 feet in length. The joints are made of seamless brass tubing and are arranged so that the sections are securely locked together when the line pole is in use. The poles are so designed that the middle joint may be omitted if desired, thereby reducing the length of the line pole from 18 to 12 feet.

Contact with the line wires is made by means of a connecting clamp which consists of a metal hook equipped with a spring. When the hook engages the line wire the spring forces the wire into contact with the hook and at the same time scrapes the wire slightly so that a good contact is obtained.

Code No.

3 For Making Contact with 2 metallic conductors.

4 1 metallic conductor (grounded line)

5 2 metallic conductors.

Cord

100 feet of M2J two conductor cord For use with 1330E, 1331E, 1332A & E Telephones.

100 feet of M1A two conductor cord. For use with 1314A Telephones.

100 feet of M2K two conductor cord. For use with 1330E, 1331E, 1332A & E Telephones.

Description

The top section is equipped with two arms hinged at the lower end. These are each equipped with a connecting clamp and are of such length that they will span wires spaced up to 2 feet horizontally.

The top section has one connecting clamp only.

The top section is equipped with two connecting clamps. One of these is fixed to the pole and the other free but under control of the user by means of a long cord. This is intended for making connections between two line wires spaced up to 5½ feet, either horizontally or vertically.

RAILWAY TRAIN DISPATCHING TELEPHONE SYSTEMS
PLUGS

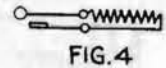
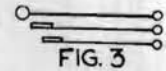
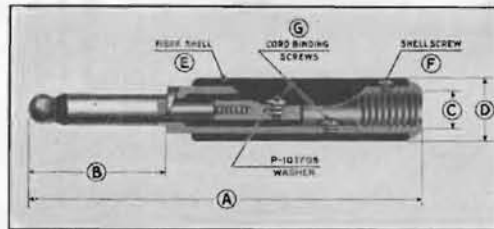
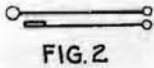
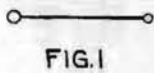
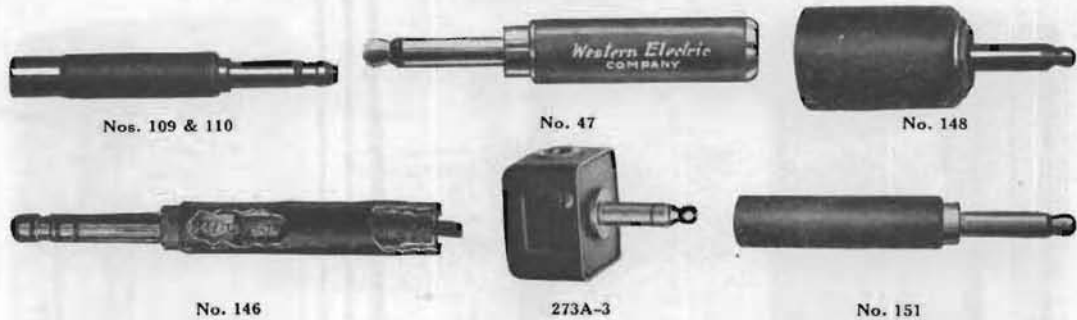

Dimensions and Replacement Parts

Code No.	Conductors	Dimensions				Used with Jack Nos.	Used with Cords	Notes	Replacement Parts (See Cut)		
		A	B	C	D				E	F	G
1A	Fig. 1	3 1/16	1 3/16	3/16	3/16	Same as for 47A Plug	511	(Shell Frame Fully Insulated)	P-146711	P- 82233	P- 84662
3A	Fig. 2	3 1/16	1 3/16	3/16	3/16		536		P-147704	P-162652	P-162653 & 4
47A	Fig. 2	3 3/16	1 3/16	3/16	3/16	281, 297, 303A, 309, 327, 353, 355, 361, 364	P2A, W2F, P1B, P2T, 768	47A has Red Shell 47B has Black Shell	P- 81335	P- 82233	P- 82239
47B									P-110576	P- 82233	P- 82239
109	Fig. 3	3 1/16	1 3/16	3/16	3/16	92, 292, 246, 248, 249, 323, 358A	S3A	*Has Red Shell	P- 81319	P- 81212	P- 82341
110	Fig. 3	3 7/16	1 3/16	3/16	3/16	49, 50, 70, 141, 259, 260, 274, 275, 267, 280, 284, 285, 289-291, 293, 295, 300, 308, 324, 326, 347, 358B, 359, 360, 362, 363, 365	S3B, P2B, W3C, W2C, S2B, S1B, P1C, P3E	*Has Red Shell	P- 81200	P- 81299	P- 82341
116	Fig. 1	3 3/16	1 3/16	3/16	3/16	Same as for 47 Plug	510, 511, 513, 519	*Has Red Shell	P- 81335	P- 82233	P- 84662
136	Fig. 2	3 3/16	1 3/16	3/16	3/16	99, 152	369	Red Shell	P- 81335	P- 82233	P- 82239
144	Fig. 1	3 3/16	1 3/16	3/16	3/16	Same as for 47 Plug	W1A	Has Cord Bushing	P- 81335	P- 82233	P- 84662
145	Fig. 2	3 7/16	1 3/16	3/16	3/16	186	658, S2D		P- 81200	P- 81299	P- 82341
146	Fig. 2	7 1/16	2 3/4	5/16	13/16		509	1330, 1331 Tel.	P-143217		P-127343
150	3 7/16	1 3/16	3/16	3/16	Same as for 110 Plug	Nonrequired	For plugging out signals in lines in trouble	P-141633	P-124071	
151	3 13/16	1 3/16	3/16	3/16	Same as for 47 Plug	Nonrequired		P-141307	P-123581	
153A	Fig. 4	4 1/16	1 3/16	3/16	3/16	Same as for 47 Plug	Nonrequired	See Note 1	P-143232	P- 81299	
153B									P-143233		
153C									P-143234		
165	2 1/16	1 3/16	3/16	7/16	Same as for 47 & 116		See Note 2			
221	Fig. 2	3 7/16	1 3/16	3/16	2 1/2	Same as for 47	(Same as for 47)	(Has large red insulating shell)	P-203388	P- 82233	P- 82239
273A-3	Fig. 3	1 7/8	1	77, 78, 190	Replaces 148	P-238714	P-299033

Note 1. The No. 153 Type Plug has a resistance unit connected so that when the plug is inserted in a jack the resistance unit is bridged across the tip and sleeve spring. The resistance unit will carry 1/10 ampere continuously without injury. The values are as follows: No. 153A Plug, 400 ohms. No. 153B Plug, 600 ohms. No. 153C Plug, 800 ohms. Used in Morse circuits for limiting the amount of battery current.

Note 2. No. 165 is a wooden dummy for opening jacks which use the Nos. 47 or 116 Plug.

*The following shells can be furnished for the Nos. 109, 110, 116 Plugs when specified on order:

Plug No.	Gray Shell	Black Shell
109	P- 90065	P- 91143
110	P-107882	P-107872
116	P-110576

RAILWAY TRAIN DISPATCHING TELEPHONE SYSTEMS

Plugs (Continued)



No. 137

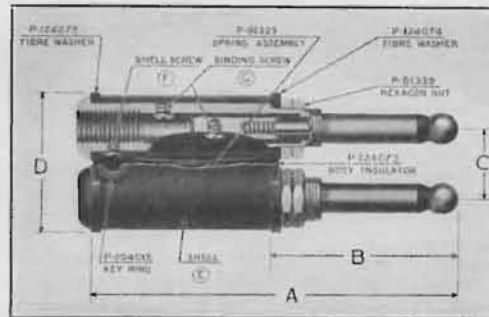

No. 241

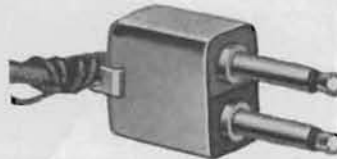

No. 246A

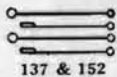

137 & 152



241A & B



241C



211 & 213

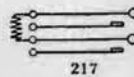

217

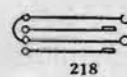

218



246A

Circuit Arrangements

Twin Plugs

When an operator's headset is to be used at a switchboard, it is convenient to wire two adjacent jacks for providing the necessary connections into the switchboard circuit and to use a twin plug in these two associated jacks in order that the necessity for the operator handling two separate plugs may be avoided. This practice is now standard and the Nos. 30, 78, and 80 Jack Mountings are designed for use with jacks so mounted that a twin plug may be inserted only in those jacks which are to be used together.

These plugs include a self-adjusting or flexible feature which allows sufficient movement of each plug in the shell to take up any slight off-centering present in the jacks.

Code No.	Conductors (Each Plug)	Dimensions				Used with Jack Nos.	Used with Cords	Used for	Replacement Parts (See Cut)		
		A	B	C	D				E	F	G
137	2	3 11/16	1 3/16	3/8	1 13/16	{99, 215-237, 281, 1297	{87, 371, 555, 562, 565, 745, 748, 749, 848, L2E, L3E, L3F, P4C	Standard operator's head telephone	P-124076	P-124071	P-82239
152	2	3 3/16	1 3/16	{29/64 to 41/64}	1 1/4	Same as 137	{87, 550, 568, W2G, 1674	Same as No. 137 but has ridges in shell to identify one side from other	P-142984	P-124071	P-82239
186	2	1 25/32	2 1/16	3/16	1 13/16	No. 19C Test Set	747	No. 19C Test Set	P-205776	P-158989
211	3	3 7/16	1 3/16	3/16	1 15/16	49	P-163952	P-81299	P-82341
213	3	3 7/16	1 3/16	1 1/16	1 3/16	{49, 50, 70, 141, 259, 260, 274, 275, 295, 238-245	P-164090	P- 81299	P-82341
241A	2	3 17/32	1 13/16	3/8	1 3/16	{99, 297, and similar types	{520, W3D, P3G, 855, P2T (See Note 1) L4A	Black Shell Red Shell Black Shell (Operator's telephone set	P-206009	P-229777
241B						P-206010				
241C						P-206009				
246A	2	2 11/16	1 3/16	3/8	1 3/16	{215 or similar type	P-212688	P-82239

Note 1. No. 241 Type Plug has brass frames of the two plugs electrically connected to the two plug sleeves; the tips are separately insulated.

RAILWAY TRAIN DISPATCHING TELEPHONE SYSTEMS
PROTECTORS

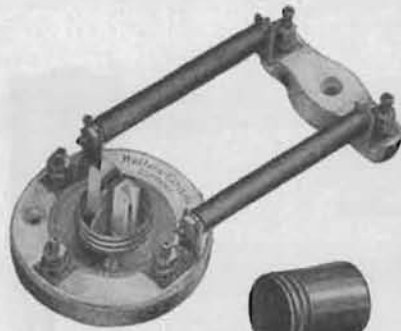

No. 58AP Protector

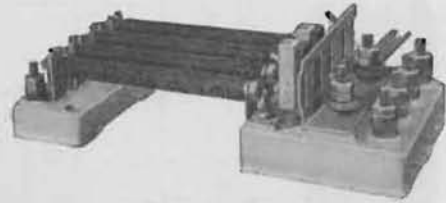

No. 1079AP Protector

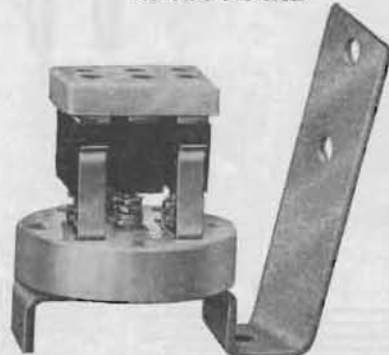

No. 86B Protector, (Cover Removed)

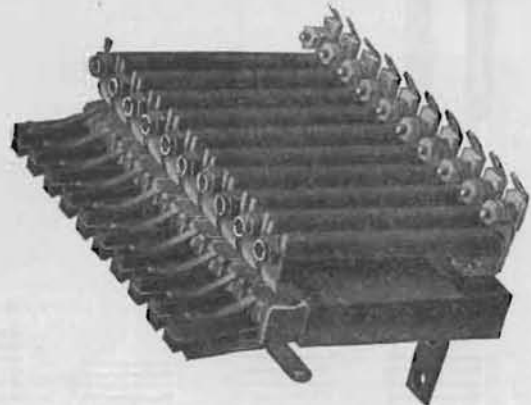

No. 1074A Protector

Code No.	Line Protection	Protector Mountings	Consists of Protector Blocks	Fuses	Protects Against
*58AP	2-Wire	{ 1 No. 29B 1 No. 16 1 No. 48	{ 2 No. 26 2 No. 27	{ 2 No. 11C (7 amp.)	{ High potential (lightning) and abnormal currents.
58BP	2-Wire	{ 1 No. 29B 1 No. 16 1 No. 48	{ 2 No. 26 2 No. 30	{ 2 No. 11C (7 amp.)	{ High potential currents (lightning.) Same as 58AP, less No. 16 and No. 48 Mountings and fuses.
76AP	2-Wire	1 No. 29B	{ 2 No. 26 2 No. 27	{ High potential and abnormal currents.
86B	2-Wire	{ High potential and abnormal currents. Units for mounting in wood cable terminals. Furnished 10 per strip, each strip supplied with a strap for connecting to others mounted in tiers and a strap hook for connecting the ground wire.
93A	{ 10 per strip	10 No. 72A	{ 10 No. 20 10 No. 25 10 No. 11 (mica)	{ 10 No. 51A and 10 No. 74 cord tips	{ High potential and abnormal currents.
1074A	{ As Required	74A	{ 1 No. 19 1 No. 20 1 No. 11 (mica)	{ 1 No. 7A (7 amp.)	{ High potential (lightning) and abnormal currents for group mounting. Fuses mount on 3/8 inch centers. Common ground strips are furnished for interconnecting two or more units.
**1079	4-Wire	{ 1 No. 79A 1 No. 80A	{ 4 No. 26 4 No. 27	{ 4 No. 11C (7 amp.)	

Note: *Two No. 60A Fuses and one No. 16 Protector Mounting may be used with the No. 58AP Protector as a sneak current arrester for private branch exchange protection.

**Four No. 60A Fuses and one No. 80 Protector Mounting may be used with the No. 1079AP Protector as a sneak current arrester for private branch exchange protection.

RAILWAY TRAIN DISPATCHING TELEPHONE SYSTEMS PROTECTOR BLOCKS

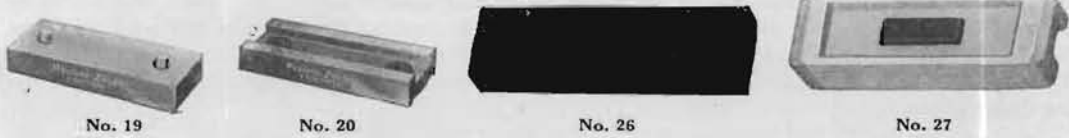

NOS. 19, 20 AND 25 TYPES

The Nos. 19 and 20 Protector Blocks are used together and form an open-space cutout suitable for protection against high potential due to lightning. A mica separator is placed between the blocks to secure the necessary air gap, the No. 10 Protector Mica usually being used for this purpose; when a higher breakdown voltage is desired the No. 11 Mica which is twice as thick may be used, thereby raising the voltage necessary to produce an arc across the air gap to approximately double the usual value. An open space cutout having a fusible metal plug in one side may be obtained by using the Nos. 20 and 25 Protector Blocks and a mica separator.



Code No.	Description	Used with Protectors
19	Plain copper block with two pins	60B and 80A
20	Grooved copper block with two bushings	60B and 80A
25	Plain copper block with two pins and fuse metal	Used in place of No. 19 Protector Block when fuse metal is desired.

NOS. 26 AND 27 TYPES

The Nos. 26 and 27 Protector Blocks are of new design and embody several advances in construction which greatly reduce maintenance costs and provide better telephone service through fewer interruptions of operation. They are used together without a separator (protector mica) and form an open space cutout which will afford the highest grade of protection against high potentials due to lightning. The two blocks differ in construction as follows:

The No. 26 Protector Block is a solid piece of hard non-dusting carbon. The face of the block is especially ground to present a smooth surface. The No. 26 Protector Block is mounted on the ground side of the protector mounting.

The No. 27 Protector Block consists of a porcelain frame with a countersunk hard carbon plug which is fastened in place with low temperature fusing cement. The surface of the frame which bears against the No. 26 Block, when assembled in a mounting, is finished by grinding. The air gap between the carbon insert in the No. 27 Block and the face of the No. 26 Block is held to close limits by this grinding process and the consistent operation of the cutouts at the proper voltage is thereby insured.

Ordinary lightning discharges will cause an arc across the air gap between the carbon blocks but will not heat them sufficiently to melt the cement used for holding the carbon plug in place. A cross with an electric light or power line, however, will cause a discharge or repeated discharges, of such duration that the heating of the carbon insert of the No. 27 Blocks will melt the cement holding it in place and allow the mounting spring to push it into direct contact with the No. 26 Block, thus permanently grounding the line.

Code No.	Description	Used with Protectors
26	Carbon block	Nos. 12AP, 58AP, 60AP, 76AP, 1079AP, 1268A and 1269A. No. S3A Protector Mounting.
27	Porcelain frame with carbon insert	Same as No. 26, except No. S3A Protector Mounting.
28	Carbon block	For use with 29 Block.
29	Porcelain frame with carbon insert	Central Office protectors on 3/8 inch centers.
30	Porcelain frame with carbon insert	S3A Protector Mounting.

RAILWAY TRAIN DISPATCHING TELEPHONE SYSTEMS

Protector Blocks and Micras (Continued)

The Nos. 26 and 27 Protector Blocks are interchangeable with the old combinations of Nos. 1 and 2 Protector Blocks and No. 3 Protector Mica both at subscribers' stations and central offices, and are therefore available for improving protective equipment already in service. This practice will result in fewer visits of the trouble man. All orders for replacements of Nos. 1 and 2 Protector Blocks and No. 3 Protector Micras should specify the Nos. 26 and 27 Protector Blocks; no separator (protector mica) is needed for the new design of block.

In addition to the above replacements, tests on cable protection have shown that Nos. 26 and 30 Protector Blocks require less attention and replacement due to grounded blocks than the Nos. 19 and 20 Blocks with the regulation .010-inch mica separators; therefore, the Nos. 26 and 30 Protector Blocks can be used advantageously wherever metal (Nos. 19 and 20) blocks are now used.

PROTECTOR MICAS

Code No.	Used with Protector Blocks	Used with Protectors
10	Nos. 19 and 20	Nos. 60B and 80A
*11	Nos. 19 and 20	No. 17B

*No. 11 Mica is twice as thick as the No. 10.

VACUUM TUBE RECTIFIER

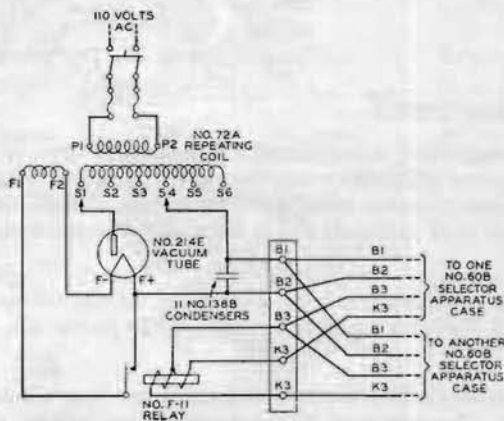

Schematic Diagram of
60B Vacuum Tube Rectifier

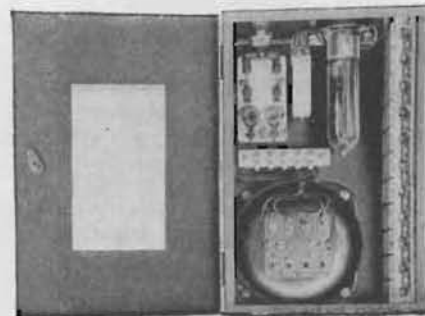

No. 60B
Rectifier Cabinet

60B VACUUM TUBE RECTIFIER

The No. 60B Vacuum Tube Rectifier as shown above is operated from a 110 volt 60 cycle alternating current source and may be used instead of dry cells, storage cells, or a motor generator set to furnish the main power for operating one or two selector circuits. It does away with the periodic tests of dry cells, the charging of storage cells, or the continuous large power drain of the motor generator set.

Description

The No. 60B Vacuum Tube Rectifier consists of a fuse and switch block, one No. 72A Repeating Coil, one No. F11 Relay, eleven No. 138B Condensers, vacuum tube socket for mounting the Western Electric No. 214E Vacuum Tube, and a terminal block mounted in a black finish steel box 18" high, 12" wide, 6½" deep. The weight is approximately 60 pounds.

For further information regarding the operation of this rectifier refer to pages 21 and 23 of this catalog.

RAILWAY TRAIN DISPATCHING TELEPHONE SYSTEMS

RELAYS

Code No.	Resistance (Ohms)	Description	Used
F11	2 windings 55 ohms each	In No. 60B Vacuum Tube Rectifier.
M3	Two "R" type relays mounted on an individual mounting.	By railways in selector circuits.
R323	3600	No. 60B Test Set.
R332	2250	Nos. 62 and 63 type Selector Keys.
R1027	95	No. 60A Time Sending Set.
R1971	100	Equipped with platinum contacts.	In No. 60B Selector Apparatus Case.
26A	25	Code repeating relay.	In Nos. 51A and 53A Apparatus Cases.
27A	Code repeating relay (replaces Relay List No. 100865).	In No. 60B Selector Apparatus Case.
122EW	100	Holding relay.	No. 60A Time Sending Set.
149AN	167	In No. 60B Selector Apparatus Case.
221JB	335	Holding relay.	On inter-calling selector circuits. No. 52A
120281	50	Selector sending.	Selector Apparatus Case.

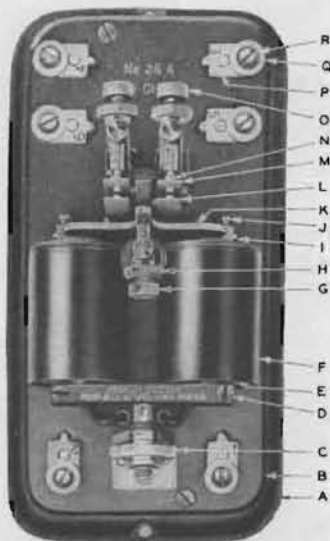

No. 26A Relay

No. 26A Relay Repair Parts

Symbol	Subject	26A Telegraph Relay
A	Sub-base	P-95884
B	Base	P-97467
C	Adjusting Nut	P-95889
D	Coil Mounting Screw	P-95965
E	Coil	P-98584
F	Coil Shell	P-95919
G	Stop Screw	P-97484
H	Check Nut	P-95899
I	Bearing	P-95930
J	Bearing Screw	P-99930
K	Armature	*P-97470 P-97471
L	Contact Spring	*P-92339 P-97481
M	Contact Spring	*P-92341 P-97481
N	Bone Stud	P-97471
O	Contact Screw	*P-97482 P-97483
P	Binding Post	P-97927
Q	Binding Post Washer	P-97937
R	Binding Post Screw	P-118454
	Clamp Plate	P-92343
	Pileup Screw	P-116879
	Bushing	P-93293
	Small Insulator	P-97478
	Large Insulator	P-97477
	Base Terminal Clip	P-95903
	Coil Support	P-95904

* To be assembled.



No. 27A Relay

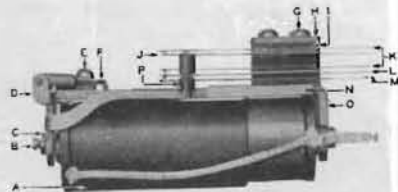

No. 221JB Relay

No. 221JB Relay Repair Parts

Symbol	Subject	221JB Relay
A	Coil	P-250737
B	Armature Travel Screw	P-250207
C	Armature Travel Nut	P-250211
D	Armature	P-250218
E	Armature Screw	P-126075
F	Clamping Washer	P-250208
G	Pileup Screw	P-250150
H	Clamping Plate	P-250095
I	Insulator	P-250212
J	Contact Spring	* P-250646 P-250891 P-260310
K	Contact Spring	P-250678
L	Contact Spring	P-250223
M	Contact Spring	P-250636
N	Armature Stop	P-250206
O	Pole Piece	P-250260
P	Armature Plug	P-250213

* To be assembled.

RAILWAY TRAIN DISPATCHING TELEPHONE SYSTEMS

RECEIVERS



No. 131 Receiver

No. 186 Receiver
(3B Headband)

Code No.	Description	HEAD TYPE	Used
186	A metal case, black finish, single head receiver with a rubber ear piece, and No. 3B Headbands. Approximate resistance 400 ohms. Replaces No. 156W.		With Nos. 1042AB, BR Desk Stands, 1293AE, AK, 1317AW, AE Telephone Sets, 1020C, E, 1048DA, DB, DC, DD, GA, GB, GC, GD Arms. With Nos. 546 and 554 Cords.
189	Similar to the No. 186 except wound to a low resistance. Approximate resistance 45 ohms. Replaces No. 148W.		With Nos. 1042AB Desk Stand, 1017B, C, E, 1020A Test Sets, 1120C, 1148DA, DB, DC, DD Telephone Arms, and 1317 BU Telephone Set. At way stations with No. 501 Type Desk Set Boxes. Also with No. 565 Cords.
515	Brass, black finish. Approximate resistance 45 ohms.		With No. 1017 Type Test Sets.
528	Brass, black finish, single head receiver with No. 11A Headband. Approximate resistance 80 ohms.		With cords having No. 80 Cord Tips at receiver end. (See Test Board Cords, page 41.)

No. 528 Receiver
(11A Headband)

HAND TYPE



144, 508, Equipped with Cord

Code No.	Description	Used
133	Insulated bipolar hand receiver with rubber case. Resistance 70 ohms.	With No. 1314A Telephone Set.
144	A concealed binding post hand receiver. Hard rubber case. Approximate resistance 83 ohms.	With Nos. 1040U, 1040AL deskstands, 1305AC, 1312A, 1317P, S, AH, BK, CN, CR, CP, CS, CG, 1336H and 6023A Telephone Sets, and 1020CC Telephone Arm.
508	A concealed binding post hand receiver. Same as the 144 except that it is wound to an impedance of approximately 2,000 ohms at 800 cycles.	With Nos. 1317W, AD, 1293AD, AK and 1336F Telephone Sets.

HAND SET TYPE

Code No.	Description	Used
131	Black or nickel finish. Resistance 71 ohms.	With No. 1001 Type Hand Sets.

RAILWAY TRAIN DISPATCHING TELEPHONE SYSTEMS

Receivers (Continued)

Receiver Replacement Parts

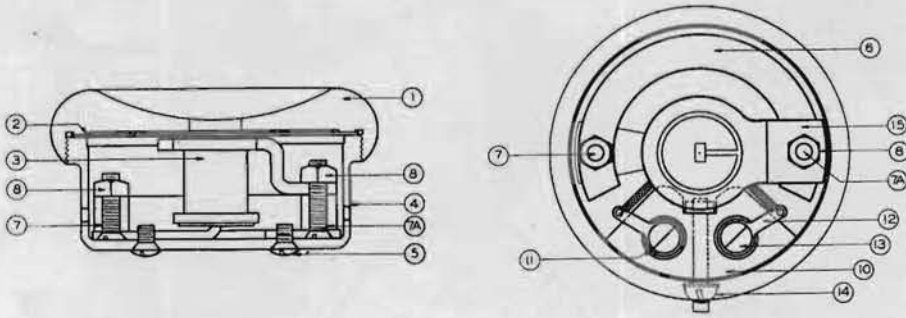

Fig. 1

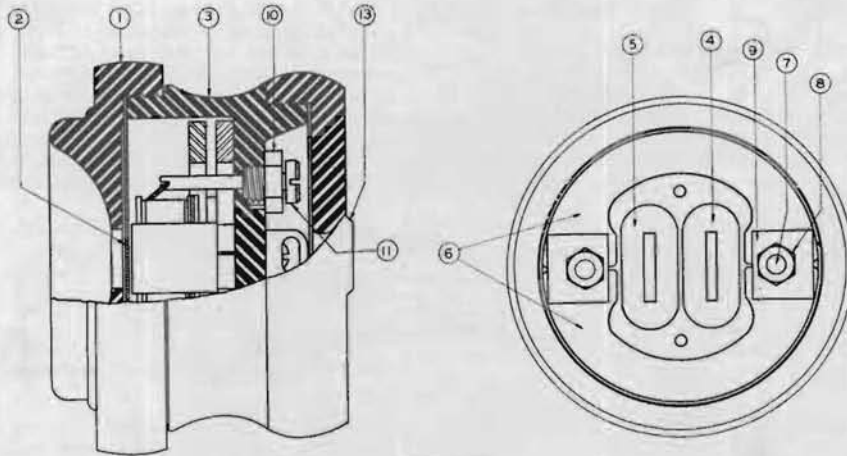

Fig. 2

Sym- bol	Name of Piece Part	Receiver Code Nos.	
		186, 189, 515 (See Fig. 1)	528 (See Fig. 1)
1	Receiver Cap.....	P-94545	P-213314
2	Diaphragm.....	P-95225	P-98387
3	Right Coil.....	*P-207460	P-230412
3	Left Coil.....		P-230411
4	Case.....	**P-215907	P-98949
5	Case Screws.....	P-97053	
6	Magnet.....	P-97064	P-99862
7	Magnet Machine Screws.....	P-97055	P-99541
7A	".....	P-97056	P-99541
8	Magnet Machine Screw Nuts.....	P-132958	P-98752
9	Receiver Block Assembly.....	P-132958	
10	Binding Post Block.....	P-98974	P-233887
11	Binding Posts.....		P-98358
12	Terminal Lugs.....	P-97062	P-229679
13	Terminal Lug Machine Screws.....	P-93540	P-99794
14	Round Head Machine Screw Nut.....	98975	P-99540
		P-92609	P-99100
15	Ring Pole Piece.....	P-97066	†P-99101

Sym- bol	Name of Piece Part	Receiver Code
		No. 133 (See Fig. 2)
1	Receiver Cap.....	P-98947
2	Diaphragm.....	P-95118
3	Case.....	P-95718
4	Right Coil.....	P-80724
5	Left Coil.....	P-80723
6	Magnets.....	P-87383
7	Magnet Machine Screws.....	P-107062
8	Magnet Machine Screw Nuts.....	P-87115
9	Magnet Clamp.....	P-87410
Receiver Block Assembly		
10	Binding Post Block.....	P-93592
11	Binding Post Screw.....	P-87411
12	Round Head Machine Screws.....	
13	Terminal Cap.....	P-220225

* P-207461 for the 189 and 515.
 ** P-215906 for the 189 Receiver.
 † P-215905 for the 515 Receiver.
 ‡ Locking Nut.

RAILWAY TRAIN DISPATCHING TELEPHONE SYSTEMS

Receiver Replacement Parts (Continued)

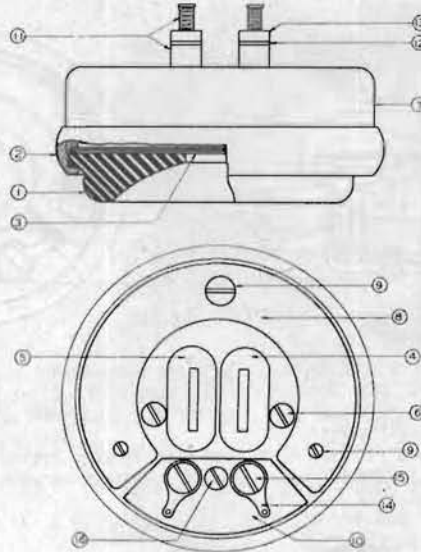

Fig. 3

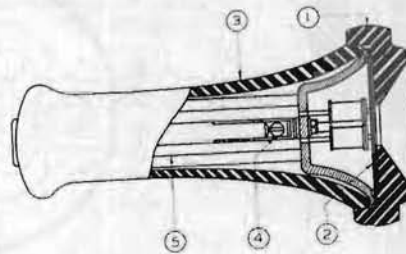

Fig. 4

Symbol	Name of Piece Part	Receiver Code Nos. 131 (See Fig. 3)	Symbol	Name of Piece Part	Receiver Code Nos. 131 (See Fig. 3)
1	Cap.....	P-81496	11	Binding Post.....	P-81497
2	Ring Nut.....	P-98439	12	Washers.....	P-132152
3	Diaphragm.....	P-81525	13	Nuts.....	P-82275
4	Right Coil.....	P-95265	14	Terminal Lugs.....	P-81500
5	Left Coil.....	P-95276	15	Terminal Lug Machine Screws	P-82027
6	Core Screws.....	P-98336	16	Round Head Machine Screw..	P-82029
7	Case.....	P-98956			
8	Magnets.....	P-81488 (2)			
		P-81489 (1)			
9	Magnet Machine Screws.....	P-68568 (2)	1	Receiver Cap.....	P-98948 P-99073
		P-82028 (1)	2	Diaphragm.....	P-95114 P-95114
		P-81499	3	Case.....	P-220224 P-93518
10	Receiver Block.....	P-81498	4	Machine Screw.....	P-93799 P-93799
	Binding Post Block.....	P-81498	5	Inner Unit.....	P-94436 P-99071

HEAD BANDS (Receivers)

Code	Description
1B	Consists of a wire head band with olive drab textile covering, equipped with adjustable yokes for holding two No. 528 Receivers (less the No. 3A Head Band ordinarily furnished).
1C	Similar to No. 1B, except for use with two No. 128 Receivers.
3B	Wire head band covered with black sleeving; for use with 186 Receiver.
11A	Wire head band and head band pad; used as part of No. 528 Receiver.

RAILWAY TRAIN DISPATCHING TELEPHONE SYSTEMS REPEATING COILS



No. 76A



No. 77A



No. 121A



No. 56A



No. 70A

NOS. 70A, 76A, 77A, AND 78A TYPES

The following coils are intended for use in phantom and simplex circuits.

The No. 70A is for use in connection with A.C. selectors.

The No. 72A is used in the No. 60B Rectifier. Is mounted on a wooden base $4\frac{1}{16}'' \times 4\frac{1}{16}''$.

The No. 76A has two coils mounted on a wood base.

The Nos. 77A and 78A are each equivalent to one-half of No. 76A.

The No. 78A also consists of two resistance units enclosed in shell, each unit is non-inductively wound and is adjusted to have approximately the same D.C. resistance as the corresponding repeating coil windings. Intended for use at intermediate stations on phantom lines where one side of phantom circuit is terminated, the phantom circuit and the other side circuit going through.

Code No.	No. of Coils	No. of Windings Each Coil	Resistances, Ohms			Impedance Ratio	Dimensions of Wood Base, Inches
			Primary	Secondary	Tertiary		
70A	1	4	2 of 45	2 of 40	1 to 1	11 x $8\frac{3}{8}$
76A	2	4	2 of 20	2 of 21	1 to 1	$10\frac{3}{4} \times 4$
77A	1	4	2 of 20	2 of 21	1 to 1	6 x 4
*78A	.	4	2 of 20	2 of 21	1 to 1	$10\frac{3}{4} \times 4$

* Has two resistance units. See above notes.

NO. 25 TYPE

The No. 25E Coil is intended for use in Nos. 1278 and 1302 Types of railway telephone sets. Base of coil provided with mounting lugs.

Code No.	No. of Coils	No. of Windings Each Coil	Resistances, Ohms			Impedance Ratio	Dimensions of Wood Base, Inches
			Primary	Secondary	Tertiary		
25E	1	2	42	42	1 to 1	$3\frac{7}{8} \times 4\frac{1}{8}$

NO. 56 TYPE

The No. 56 Type Coils are intended for use in circuits designed for obtaining ringing current from central office storage batteries, in conjunction with No. 84 Type Interrupters.

Code No.	No. of Coils	No. of Windings Each Coil	Resistances, Ohms			Impedance Ratio	Dimensions of Wood Base, Inches
			Primary	Secondary	Tertiary		
56A	1	3	2 of .85	1 of 22.5	11 x $8\frac{5}{8}$
56B	1	3	2 of 2.35	1 of 27.7	11 x $8\frac{5}{8}$

NO. 121 TYPE

The No. 121A Repeating Coil is intended for protecting subscribers sets from high potential hazards when the telephone lines are located in the exposure area of high tension power lines.

121A Consists of toroidal type coil potted in a cast iron case arranged for panel and telephone pole mounting. Average D.C. resistance of the set winding 131 ohms and of the line winding 37 ohms. Optimum terminating impedance of the subscriber's set winding and the line winding is 600 ohms each. Case is furnished with 6' leads. Height $14\frac{3}{4}''$, width $13\frac{1}{4}''$. Replaces the No. 50A Repeating Coil except for additions and maintenance purposes.

RAILWAY TRAIN DISPATCHING TELEPHONE SYSTEMS

RETARDATION COILS



No. 5AA



No. 44F



No. 5AF



No. 51A

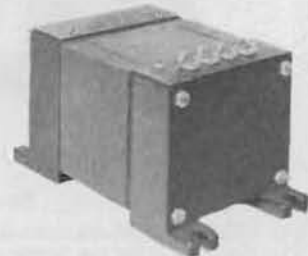

No. 152A

Code No.	Description	Used With
5AA	Toroidal type coil enclosed in a crosstalk-proof shell and mounted on a wooden base. It has two independent groups of windings; resistance of windings 74 ohms each. Base 11 x 8 $\frac{3}{4}$ inches.	Composite circuits in place of two No. 5K or two No. 5L Retardation Coils.
5AF	Toroidal type coil, in crosstalk-proof shell. Equipped with mounting brackets and has wooden base with 3 terminals. It has 4 windings, connected series aiding with tap brought out from the middle point of the series arrangement. Total resistance 330 ohms, base 3 $\frac{3}{8}$ x 3 $\frac{3}{8}$ inches.	Simplexing telephone line. Replaces No. 5AC Coil.
12G	Consists of winding with a resistance of 2.3 ohms and is equipped with movable core for varying the impedance. Size 3 $\frac{1}{2}$ x 1 x 1 $\frac{1}{2}$ inches.	Nos. 1312A and 6023A Telephone Sets.
12M	Resistance 2.3, similar to No. 12G but for portable sets. Base 3 $\frac{1}{4}$ x 1 inches.	No. 1314A Telephone Set
44F	Two toroidal coils, each enclosed in a crosstalk-proof shell and mounted on a single wooden base. Each coil has 4 inductive windings connected permanently in series (inductive aiding); the maximum resistance of the series arrangement (L-1—L-2) is 330 ohms. Terminals arranged so protector blocks on No. 53 mounting can be associated with the coil. Same as two No. 5AF coils on one base. Base 11 $\frac{3}{4}$ x 4 $\frac{3}{8}$ inches.	Used as phantom retardation coil; replaces No. 44C.
51A	Retardation coil of one winding equipped with two brass terminals bent up to an angle of 90 degrees with the head of the coil. Resistance 520 ohms. Height 1 $\frac{1}{4}$ inch, diameter 1 $\frac{1}{2}$ inch.	Nos. 295AK, special 300H and K Desk Set Boxes, Nos. 1293AD, AE, AK, AL and 1317W, AD, AE, and AW Telephone Sets.
51B	Similar to No. 51A excepting it is moisture-proof. Height 1 $\frac{1}{2}$ inch, diameter 1 $\frac{1}{2}$ inch.	No. 1336F Telephone Set.
78A	A laminated steel core mounted between two split wooden spool heads. Resistance 525 ohms. Mounted by means of angle pieces. Size 5 x 5 x 10 inches.	No. 61A Selector Apparatus Case.
152A	A shell type laminated silicon steel core provided with an air gap. Has an average effective inductance of approximately 2.7 henries with a superimposed direct current of .5 ampere. The DC resistance at 68 degrees Fahrenheit of the two windings in series is approximately 18.4 ohms. Size approximately 4 $\frac{1}{8}$ x 4 $\frac{3}{8}$ x 8 inches.	No. 60B Selector Apparatus Case. Entirely replaces the No. 5AD Retardation Coil.
158A	Potted in a sheet steel case, arranged for stud mounting. Core and windings are divided in two parts and the winding parts so interconnected as to obtain two independent inductive windings having substantially the same electrical characteristics and very low mutual coupling. Average DC resistance of windings (1-2) and (3-4) is 73 ohms each. Effective inductance of windings (1-2) and (3-4) connected in parallel ranges between 1.345 and 1.555 henries.	Intended for use in place of Nos. 5AA and 77A Retardation Coils in stud mounted DC Telegraph Composite Sets.

**RAILWAY TRAIN DISPATCHING TELEPHONE SYSTEMS
RESISTANCES**



No. 1



No. 34A

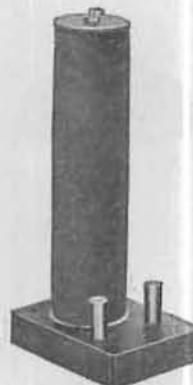

No. 35D



No. 18



No. 31A



No. 63

Code No.	Resistance (Ohms)	Used With
1F	1,000	Nos. 101A and 101B Selector Sets.
18A	37	No. 52A Selector Apparatus Case.
18G	200	No. 60A Selector Apparatus Case.
18AK	60	Nos. 51A, 52A, 53A and 60A Selector Apparatus Cases.
31A	1,200	Telegraph relays on composite circuits. Steel tube enameled resistance.
34A	200 to 30,000 9 terminals	Nos. 101A, 101B, 102A and 102B Selector Sets.
34B	100 to 3,100 6 terminals	Nos. 51C, 51D and 53A Selector Keys on intercalling circuits.
34C	4 to 3,124 9 terminals	Simplex train dispatching circuits.
34G	700 to 2,900 7 terminals	Dispatcher's Loud Speaking Telephone Circuit.
35D	250	Nos. 51A and 53A Selector Apparatus Cases. Enameled resistance.
38A	48,000	No. 160A Selector Sets.
63C	50	No. 60B Selector Apparatus Case.
63F	200	No. 60B Selector Apparatus Case.

Note—Resistance units in No. 34 Type Resistances are arranged so that various values may be obtained as follows:
No. 34A values from 200 to 30,000 ohms in steps of 200 ohms each.
No. 34B values from 100 to 3,100 ohms in steps of 100 ohms each.

No. 34C values from 4 to 3,124 ohms in steps of from 4 to 64 ohms each.
No. 34G values from 700 to 2,900 ohms in steps of from 200 to 500 ohms each.

RAILWAY TRAIN DISPATCHING TELEPHONE SYSTEMS

RINGERS



No. 38 Type



No. 51 Type



No. 60CG Ringer

Nos. 4, 32, 38, 43, 45, 51, 53 and 60 Types

Code No.	Resistance in Ohms	Gong No.	Used in
4BG	2500	29A	Nos. 1293AD and AE Telephone Sets.
32BG	2500	13	Nos. 1330E and F Telephone Sets.
38AG	1020	26A	Nos. 127E and 127 Special Extension Bells and No. 1317AH Telephone Set.
38BG	2500	26A	Nos. 127F Extension Bell, 1317P, S, W, AW and BK Telephone Sets.
38FG	1620	26A	No. 127G Extension Bell.
43NG	88	26A	No. 128H Extension Bell.
45BG	2500	20	Nos. 1336F, H and 1305AC Telephone Sets. Moisture-proofed.
*51AG	1020	29A	Nos. 1278G, and H Telephone Sets and 315H Desk Set Box.
*51BG	2500	29A	Telephone Sets and 300K and N Desk Set Boxes.
*51FG	1620	29A	Telephone Sets and 300L and N Desk Set Boxes.
53AG	1000	29A	No. 1317CG Telephone Set.
53BG	2500	29A	Nos. 1317CP and CS Telephone Sets.
53FG	1600	29A	Nos. 1317CN and CR Telephone Sets. No. 127J Extension Bell and Nos. 160A, B, C, R and 161A Selector Sets.
60CG	16	26A	Nos. 160C, R, AC, AR, BC and BR Selector Sets.

*The No. 51 Type Ringers have bent gong posts which permit of their use in woodwork drilled for ringers having three inch gongs; for example, drilled for the No. 38 Type Ringer.

RAILWAY TRAIN DISPATCHING TELEPHONE SYSTEMS

Ringers (Continued)

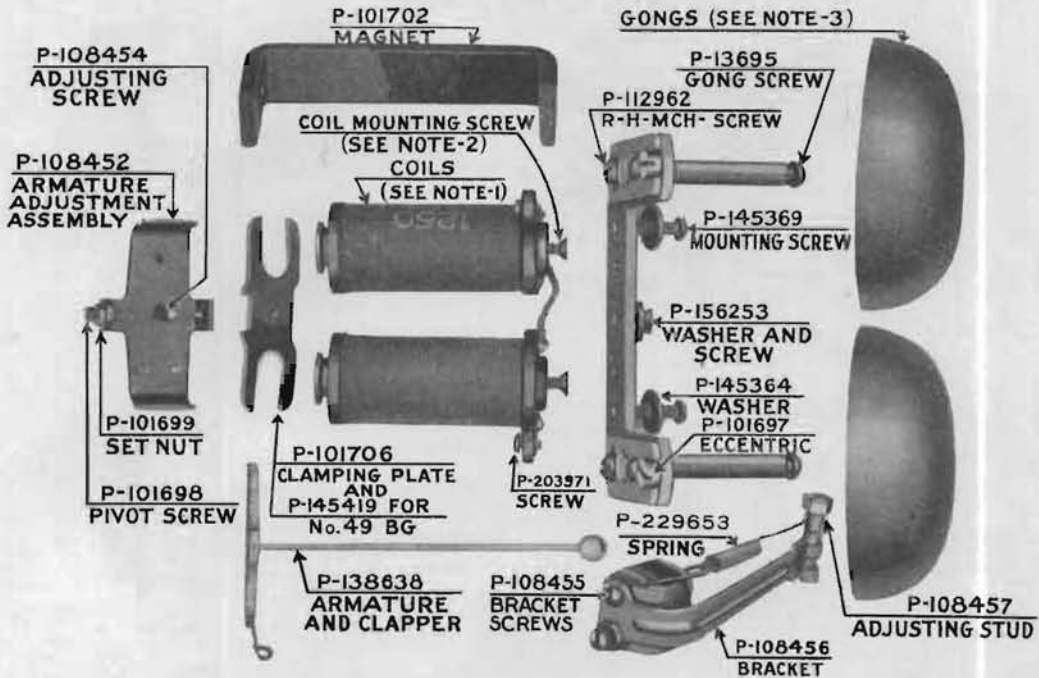

Repair Parts of Ringers

Repair parts for the Nos. 38, 51, 53 and 55 Type Ringers are the same as shown above with the following exceptions:

Description	Ringer	Ringer	Ringer	
	Coils (Note 1)	38AG } P-133726	38BG } P-133727	38FG } P-133729
		51AG } (500 ohms ca.)	51BG } (1250 ohms)	51FG } (800 ohms)
		53AG } (500 ohms)	53BG }	53FG }
	55AG—P-214144 (500 ohms)			
Coil Mounting Screw (Note 2)	38 Type			
	51 Type	P-40837	50 Type—P-38973	
	53 Type			

Note 3—Gongs for various type ringers are listed with the code numbers on the preceding page.

RAILWAY TRAIN DISPATCHING TELEPHONE SYSTEMS

Ringers (Continued)

No. 45 BG Ringer

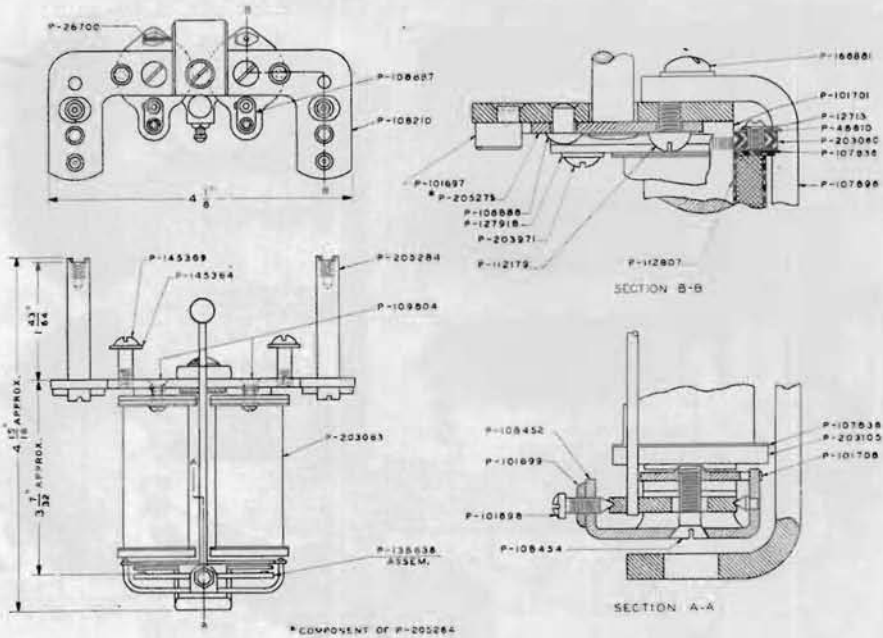

* COMPONENT OF P-205284

REPLACEMENT PARTS

Piece Part	No. Required	Material	Name
P-108452	1	—	Armature Adj. Assem.
P-138638	1	—	Clapper & Arm. Assem.
P-205284	2	—	Gong Post Assem.
P-203063	2	—	Coil Assem.
P-26700	1	—	Conductor, 1 1/2" long
P-101697	2	Brass	Eccentric
P-101698	1	Brass	Pivot Screw
P-101699	1	Brass	Hex. Nut
P-101706	1	Brass	Clamping Plate
P-203971	2	Brass	Button H. Mach. Screw
P-106888	2	Iron	Rivet
P-166881	1	Iron	Washer H. M. Screw
P-108210	1	Steel	Heel Iron
P-108454	1	Brass	F. H. Mach. Screw
P-109804	2	Iron	F. H. Mach. Screw
P-112179	2	Brass	R. H. Mach. Screw
P-107896	1	—	Magnet
P-12713	4	Brass	Eyelet
P-46610	2	Brass	Terminal
P-203105	2	Phenol Fibre	Spool Head
P-101701	2	Iron	Core
P-106887	2	Brass	Terminal
P-107836	4	Paper	Washer
P-112807	2	Paper	Insulator
*P-205275	2	Steel	Adj. Plate
P-127918	2	Brass	Special Hex. Nut
P-203060	4	Phenol Fibre	Spool Head
P-145369	2	Steel	R. H. Mach. Screw
P-145364	2	Steel	Washer

*Part of P-205284.

RAILWAY TRAIN DISPATCHING TELEPHONE SYSTEMS

Ringers (Continued)

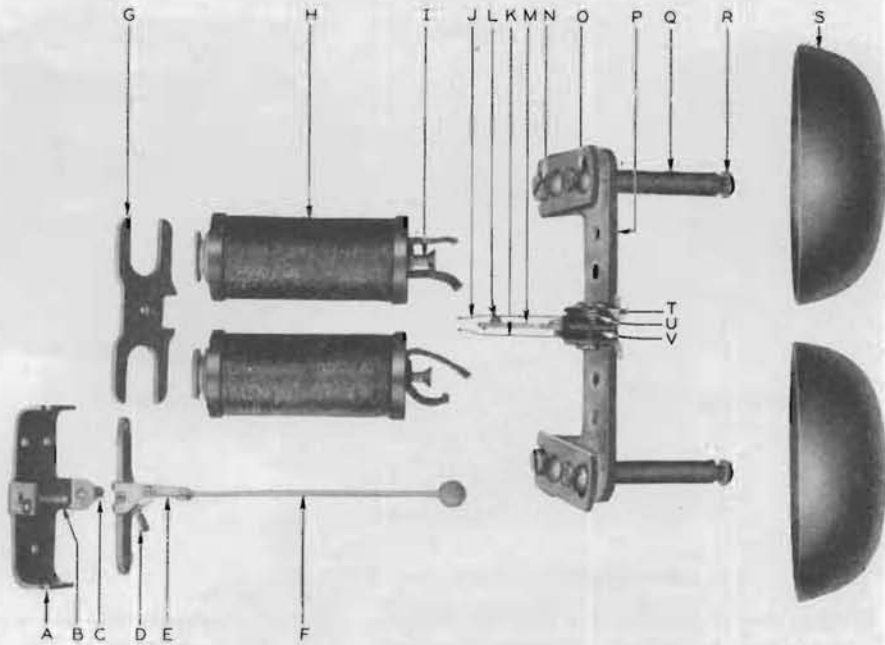

No. 60 Type Ringer

REPLACEMENT PARTS FOR No. 60CG RINGER

A	P-140855	Armature Adjuster	M	P-140847	Contact Terminal
B	P-108454	Adjusting Screw	N	P-101697	Eccentric
C	P-101698	Pivot Screw	O	P-112962	R.H. Machine Screw
	P-101699	Set Nut	P	P-140850	Heel Iron
D	P-140835	Spring	Q	P-205284	Gong Post
E	P-145539	Contact Arm	R	P-107918	Gong Mounting Screw
F	P-145541	Clapper and Armature	S	P-124456	Gong
G	P-140849	Clamping Plate	T	P-140894	Clamping Plate
H	P-140859	Coil Assembly		P-140862	Pile-up Screw
I	P- 40837	Coil Mounting Screw	U	P-140852	Terminal
J	P-140844	Contact Spring		P- 92956	Terminal Screw
K	P-140845	Contact Spring	V	P-140851	Bushing
L	P-140848	Rubber Separator		P-140857	Insulator

RAILWAY TRAIN DISPATCHING TELEPHONE SYSTEMS

SELECTIVE APPARATUS

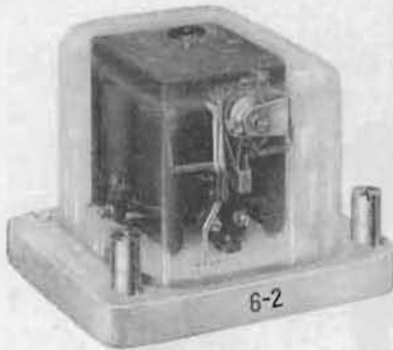

No. 50B Selector



No. 60AP Selector

Selectors

Code No.	Description	Resistance in Ohms	Used
*50A	Bridging selector mounted on a porcelain base and protected by a glass cover. Capacity 48 stations.	3750	At way stations on train dispatching circuits in Nos. 101A and 102A Selector Sets.
*50B	Group selector, first selects a group and then from this group the particular station desired. Capacity 65 stations.	16000	At way stations on train dispatching circuits in Nos. 101A and 102A Selector Sets.
*50C	Same as No. 50A except it is of low resistance and operates from a local battery in the set. Capacity 48 stations.	9.4	At way stations in No. 102C Selector Sets.
60AP	Alternating selector, mounted on phenol base and supplied with a glass cover. Operates on 17 impulses which give a total of 78 code settings. Also equipped for receiving time signals.	21000	At way stations in No. 160C or R Selector Sets.
60BP	Similar to No. 60AP except it is equipped with 4 ringing terminals so that four bells in the same station can be rung by the same selector. Not equipped for receiving time signal. Regularly set to operate on a total of 17 impulses to the first ringing terminal. Total code settings 28.	21000	At way stations in No. 160C or R Selector Sets.

*Specify on order the number of stations for which the selectors are desired. In the No. 50B Selector specify the group number and number of stations.

RAILWAY TRAIN DISPATCHING TELEPHONE SYSTEMS

Selective Apparatus (Continued)

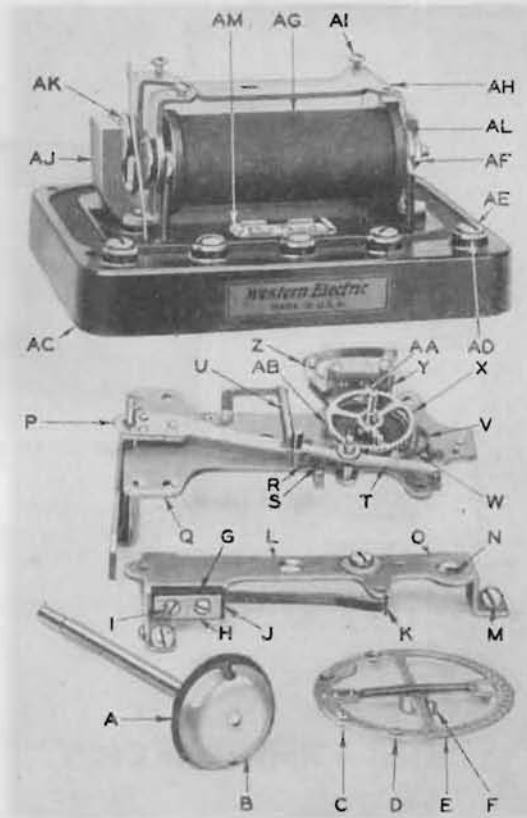

Replacement Parts for No. 60 Type Selectors

Symbol	Subject	60AP Selector	60BP Selector	Symbol	Subject	60AP Selector	60BP Selector
A	Felt Washer	P-91966	P-91966	W	Stepping Pawl Spring	P-93202	P-93202
B	Clamping Stud	P-207899	P-207899	X	Ratchet	P-137678	P-137678
C	Code Pin	P-137652	P-137652	Y	Terminal Plate	P-137658	P-137658
D	Code Nut	P-137651	P-137651	Z	Terminal Bridge Screw	P-94505	P-94505
E	Code Wheel	P-146196	P-146199	AA	Terminal Plate Screw	P-93836	P-93836
F	Code Wheel Screw	P-137650	P-137650	AB	Spiral Spring	P-137649	P-137649
G	Insulator Bushing	P-207896	P-207896	AC	Base	P-207897	P-207898
H	Clamping Plate	P-146610	P-146610	AD	Base Terminal	P-137683	P-137683
I	Clamping Plate Screw	P-93833	P-93833	AE	Terminal Screw	P-137685	P-137685
J	Insulator	P-137632	P-137632	AF	Core Lock Nut	P-121772	P-121772
K	Holding Spring	P-137636	P-137636	AG	Coil	P-228520	P-228520
L	Upper Plate	P-146308	P-146308	AH	Frame	P-146145	P-146145
M	Upper Plate Screw	P-147796	P-147796	AI	Frame Screw	P-121770	P-121770
N	Adjusting Screw	P-92642	P-92642	AJ	Magnet	P-145918	P-145918
O	Hexagon Nut	P-137686	P-137686	AK	Core	P-147431	P-147431
P	Armature	P-146148	P-146148	AL	End Play Washer	P-137641	P-137641
Q	Middle Plate	P-146306	P-146306		Card	P-92152	P-92152
R	Holding Pawl	P-137643	P-137643	AM	Card Holder	P-101963	P-101963
S	Holding Pawl Spring	P-137648	P-137648		Face Strip	P-101964	P-101964
T	Rocker Arm	P-146152	P-146152		Retaining Screw	P-223064	P-223064
U	Rocker Arm Spring	P-137692	P-137692		Glass Cover	P-162258	P-162258
V	Stepping Pawl	P-146149	P-146149				

RAILWAY TRAIN DISPATCHING TELEPHONE SYSTEMS

Selective Apparatus (Continued)

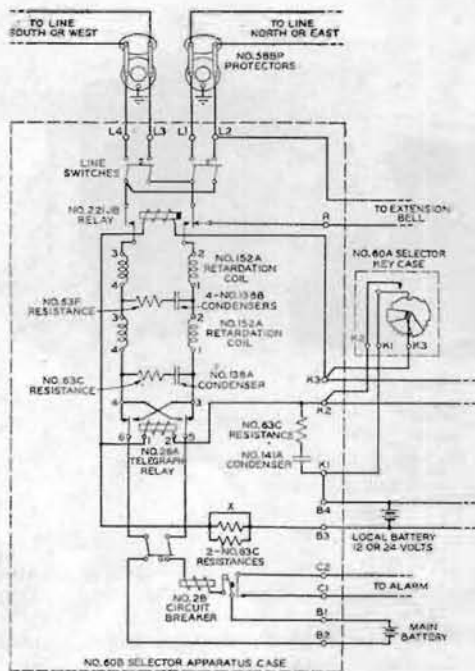

Schematic Wiring of No. 60B Selector Apparatus Case

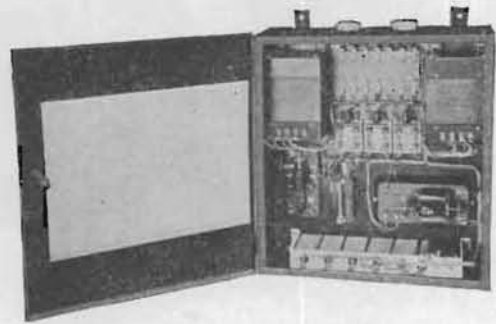

Photograph 60B Selector Apparatus Case

Selector Apparatus Cases

Code No.	Equipment	Overall Dimensions	Used At
60B	2 No. 152A Retardation Coils 1 No. 26A Relay 1 No. 221JB Relay 1 No. 2B Circuit Breaker 1 No. 629A Mounting Plate 4 No. 63C Resistances 1 No. 63F Resistance 4 No. 138B Condensers 1 No. 138A Condenser 1 No. 141A Condenser 3 No. 709 Trumbull Knife Switches DPST	1 ft. 4 $\frac{1}{8}$ in. x 1 ft. 8 $\frac{1}{2}$ in. x 6 $\frac{7}{16}$ in.	Dispatchers office on train dispatching systems (metal cabinet). Re- places No. 60A Selector Apparatus Case.
61A	1 No. 47A Repeating Coil 2 No. 21AA Condensers 1 700 ohm Ward Leonard Resistance DM 700 Type 1 No. 78A Retardation Coil 3 No. 709 Trumbull Porcelain Switches 2 No. 9171 Bryant Porcelain Receptacles 2 No. 12061 Ballast Lamps	2 ft. $\frac{5}{8}$ in. x 12 $\frac{5}{8}$ in. x 6 $\frac{7}{8}$ in.	Battery stations on inter- communicating mes- sage circuits.

RAILWAY TRAIN DISPATCHING TELEPHONE SYSTEMS

Selector Keys



No. 50A Selector Key

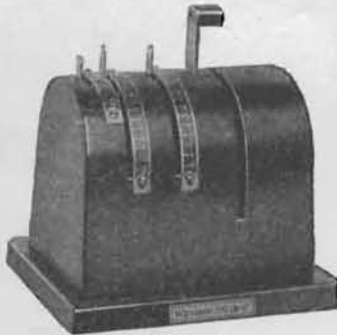

No. 61A Selector Key

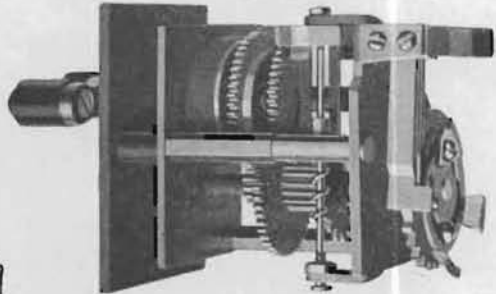

No. 60A Selector Key

NOS. 50, 53, 60 AND 61 TYPES

Code No.	Description	Used In
*50A	Individual key. Can be adjusted to select any station from 1 to 35.	Nos. 50A, B or C Selector Key Cases. At dispatcher's office. With No. 50A Selectors.
*50B	Individual key. Can be adjusted to select any station from 1 to 48.	Nos. 50A, B or C Selector Key Cases. At dispatcher's office. With No. 50A Selectors.
*50C	Individual key. Can be adjusted to select any station from 6-1 to 12-5.	Nos. 50A, B or C Selector Key Cases. At dispatcher's office. With No. 50B Selectors.
*50D	Individual key. Can be adjusted to select any station from 13-1 to 18-5.	Nos. 50A, B or C Selector Key Cases. At dispatcher's office. With No. 50B Selectors.
*50F	Individual key. Can be adjusted to select any station from 1-3 to 21-1.	Nos. 50A, B or C Selector Key Cases. At dispatcher's office. With No. 50F Selectors.
53A	Master calling key. Capacity 55 stations. Mounts 2 No. 34B Resistances.	Test boards in connection with No. 50B Selectors. Also at way stations on inter-calling circuits.
60A	Individual key. Can be adjusted to select any station from 1 to 78 and advancing all selectors to the time receiving position.	Nos. 60A, B, C, D or E Selector Key Cases. At dispatcher's office. With No. 60AP Selectors.
60B	Individual key. Can be adjusted for calling any of the code settings given for the No. 60B Selectors.	Nos. 60A, B, C, D or E Selector Key Cases. At dispatcher's office. With No. 60BP Selectors.
61A	Master key to control the sequence of calling impulses for all codes totalling 17 steps. Consists of a driving mechanism and impulse wheel mounted on a shaft and control springs mounted on the base. It is furnished with a slotted cover through which levers extend allowing changes to be made in the code settings to correspond with the codes of the Nos. 60AP and BP Selectors.	Circuits equipped with the Nos. 60AP and BP Selectors when set for a total of 17 steps to the first or A terminal. Also used on the inter-call circuits.
61B	Master key. Same as 61A except arranged to control the sequence of calling impulses for all codes for the No. 60A Selector when set for a total of 27 impulses and for the 60B Selector when set for a total of 27 impulses to the first or A terminal.	On circuits equipped with 60AP and BP Selectors when set for a total of 27 steps to the first or a terminal. Also used on inter-call circuits.

*These selector keys are of the older type and are listed for convenience in ordering for maintenance purposes and for extensions to existing circuits.

RAILWAY TRAIN DISPATCHING TELEPHONE SYSTEMS

Selector Keys (Continued)

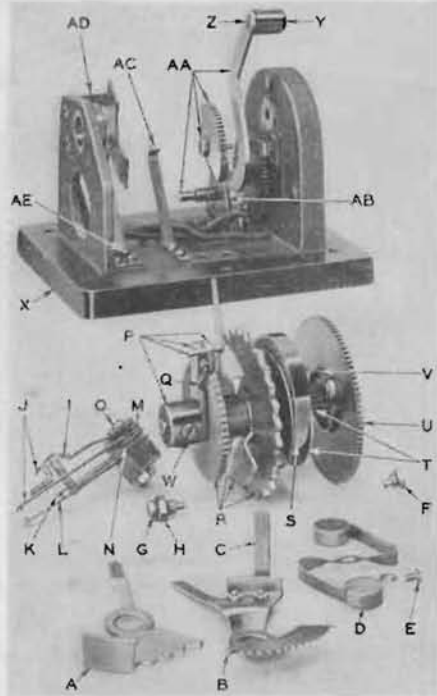
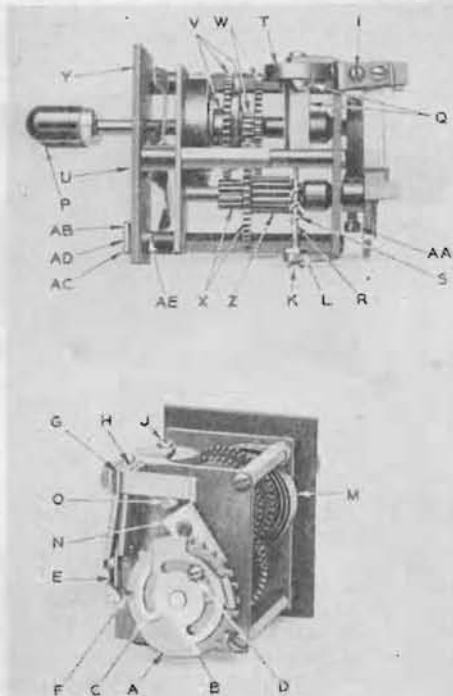

No. 60 Type

Symbol	Subject	60A Selector Key	60B Selector Key
A	Impulse Wheel	P-140791	P-140944
B	Bent Up Segment	P-140789	P-140942
C	Flat Segment	P-140788	P-140941
D	Segment Screw	P-115851	P-115852
E	Contact Spring	P-140782	P-140782
F	Contact Spring	P-140784	P-140784
G	Insulator Bushing	P-140787	P-140787
H	Insulator	P-93019	P-93019
I	Pileup Screw	P-115587	P-115587
J	Governor Pivot	P-93028	P-93028
K	Governor Pivot	P-93044	P-93044
L	Pivot Lock Nut	P-92122	P-92122
M	Main Spring	P-93040	P-93040
N	Stop	P-219298	P-219298
O	Stop Screw	P-219300	P-219300
P	Handle	P-94751	P-94751
Q	Governor	P-93393	P-93393
R	Governor Shaft	* P-93020	P-93020
S	Governor Worm	* P-93021	P-93021
T	Governor Cup	P-92113	P-92113
U	Mounting Screw	P-92132	P-92132
V	Ratchet Gear	P-93033	P-93033
W	Gear and Pinion	P-93036	P-93036
X	Gear and Pinion	P-93050	P-93050
Y	Face Plate	P-98914	P-98914
Z	Worm Wheel	P-93024	P-93024
AA	Screw	P-93487	P-93487
AB	Card	P-92152	P-92152
AC	Card Holder	P-101963	P-101963
AD	Face Strip	P-101964	P-101964
AE	Retaining Screw	P-107474	P-107474
	Large Flat Segment		P-142175

* To be assembled.

No. 61 Type

Symbol	Subject	61A Selector Key
A	Code Lever	Det. 49, A-121562
B	Code Lever	Det. 34, A-121560
C	Interlock Arm	Det. 61, A-121563
D	Governor	*Det. 2 & 4, A-121555
E	Governor Screw	P-115577

No. 61 Type (Continued)

Symbol	Subject	61A Selector Key
F	Pivot Screw	Det. 55A, A-121562
G	Pivot Screw	Det. 55, A-121562
H	Pivot Nut	P-95329
I	Locking Spring	Det. 47, A-121561
J	Contact Spring	*Det. 39 & 46, A-121561
K	Contact Spring	*Det. 40A, A-121561
L	Contact Spring	*Det. 38, A-121561
M	Insulator	Det. 41, A-121561
N	Bushing	Det. 43, A-121561
O	Pileup Screw	P-116861
P	Pawl Assembly	*Det. 28, 29, 30, 32, A-121559
Q	Pawl Spring	P-93204
R	Impulse and Ratchet Wheels	*Det. 34, 35, 36, 37, A-121560
S	Main Spring	Det. 21, A-121558
T	Spring Holder and Ratchet	*Det. 19, 20, 22, 23, 25, A-121558
U	Governor Gear	*Det. 8, 9, 10, 11, 10A, A-121556
V	Ratchet Spring	P-93030
W	Hub Screw	.138" x .32 x 1/8", A-121569
X	Base	Det. 1, A-124869
Y	Handle	P-101504
Z	Handle Screw	P-101482
AA	Operating Lever	*Det. 12, 13, 14, 16, 17, 18, 19, A-121557
AB	Latch Spring	P-93203
AC	Position Spring	Det. 50, A-121562
AD	Fixed Segment	Det. 51, A-121562
AE	Spring Screw	P-115578
	Cover	Det. 1-A, A-124867
		*61B Selector Key
A	Code Lever	Det. 49, A-121566
B	Code Lever	Det. 34, A-121565
R	Impulse and Ratchet Wheels	*Det. 34, 35, 36, 37, A-121565
AD	Fixed Segment	Det. 51 A-121566
	Cover	Det. 1-A, A-124868

Other parts same as for 61A Selector Key.

* To be assembled as per drawing A-121569.

** Parts same as for No. 61A Selector Key except as noted above.

RAILWAY TRAIN DISPATCHING TELEPHONE SYSTEMS

Selector Keys (Continued)

Nos. 62 and 63 Type

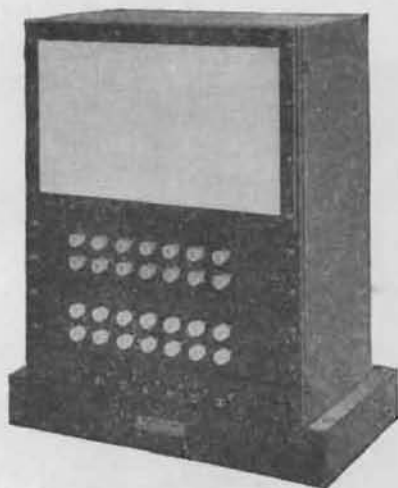

No. 62A Selector Key

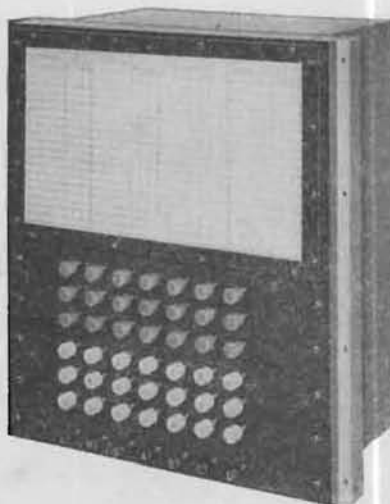

No. 63B Selector Key

The Nos. 62 and 63 Type Selector Keys are master calling keys arranged to operate any or all selectors on a line to their ringing position by pushing one small locking key in each of the two groups of keys.

The Nos. 62A and 62B Selector Keys are arranged for desk or table mounting and the main apparatus unit is arranged so that it can be removed from its base by means of a jack connection.

The Nos. 63A and 63B Selector Keys are arranged for mounting in the face equipment of a No. 604 P.B.X. switchboard between the stiles (10 $\frac{1}{4}$ " face mounting). They are arranged so that they may be removed from the switchboard either from the front or rear.

Code No.	Description	Remarks
62A	Arranged for desk or table mounting. Provides means for calling all selectors in the 17 step selector code as given in Table No. 1, page 10. These keys have two groups of 14 keys each and one group of 7 keys.	The overall dimensions are approximately 12 $\frac{1}{2}$ " high, 10 $\frac{1}{4}$ " wide and 6 $\frac{1}{2}$ " deep. The metal frame and cover are finished in black.
62B	Desk or table mounting. Provides means for calling all selectors in the 27 step selector code as given in Table No. 2, page 10. These keys have two groups of 21 keys each and one group of 7 keys.	The overall dimensions are approximately 12 $\frac{1}{2}$ " high, 10 $\frac{1}{4}$ " wide and 6 $\frac{1}{2}$ " deep. The metal frame and cover are finished in black.
63A	Switchboard mounting. Provides means for calling all selectors in the 17 step selector code as given in Table No. 1, page 10. These keys have two groups of 14 keys each and one group of 7 keys.	The overall dimensions are approximately 10 $\frac{3}{8}$ " high, 9 $\frac{3}{4}$ " wide and 6 $\frac{1}{4}$ " deep. The metal frame and cover are finished in aluminum.
63B	Switchboard mounting. Provides means for calling all selectors in the 27 step selector code as given in Table No. 2, page 10. These keys have two groups of 21 keys each and one group of 7 keys.	The overall dimensions are approximately 10 $\frac{3}{8}$ " high, 9 $\frac{3}{4}$ " wide and 6 $\frac{1}{4}$ " deep. The metal frame and cover are finished in aluminum.

Note: For further information regarding the operation of these keys, refer to page 11.

RAILWAY TRAIN DISPATCHING TELEPHONE SYSTEMS

Selector Keys (Continued)

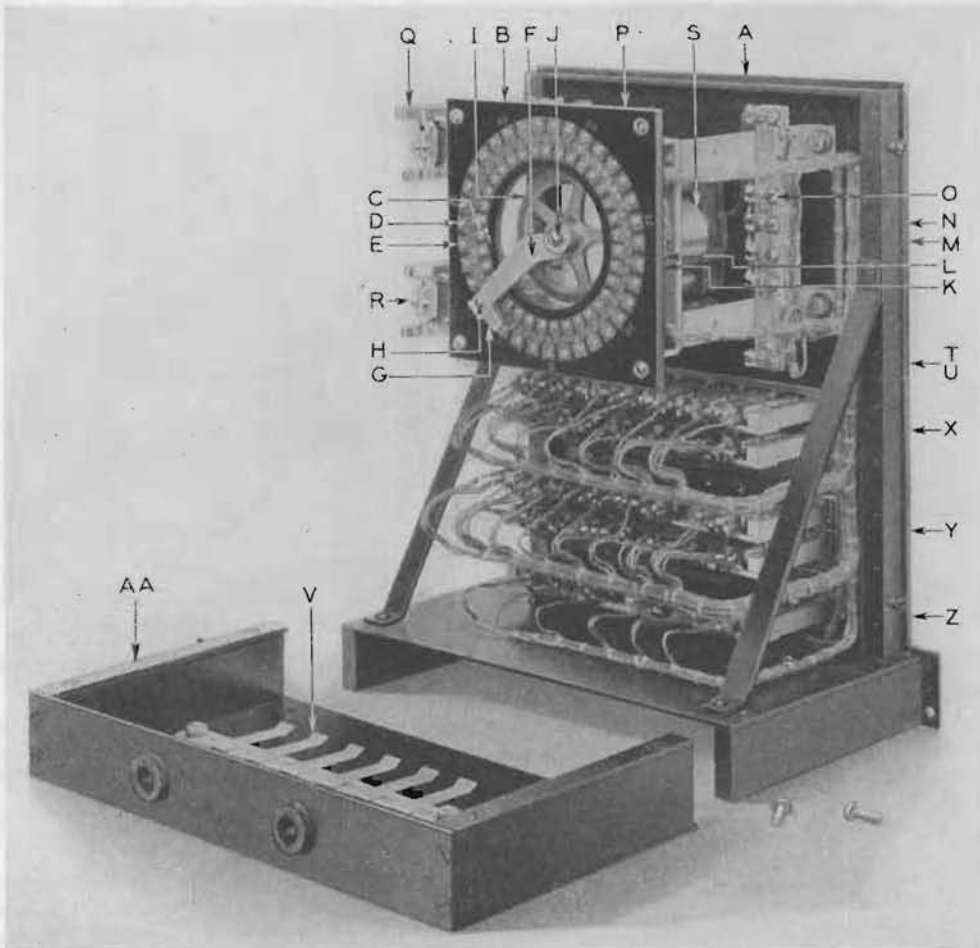

62 Type Selector Key

Symbol	Subject	62A Selector Key	62B Selector Key	Symbol	Subject	62A Selector Key	62B Selector Key
A	Distributor Panel, Complete	P-235881	P-235881	P	Resistance—Ward Leonard	Type O— 45 Ohms	Type O— 45 Ohms
B	Terminal Plate, Complete	P-235864	P-235864	Q	Relay—Start	R-1027	R-1027
C	Inner Segment	P-235866	P-235866	R	Relay—Stop	R-332	R-332
D	Outer Segment	P-235865	P-235865	S	Telechron Motor— Type B3, 1 RPS	60 cycles 110 volts	60 cycles 110 volts
E	Segment Screw	P-115586	P-115586	T	Lamp	No. 2F	No. 2F
F	Contact Arm	P-235868	P-235868	U	Lamp Socket	No. 13A	No. 13A
G	Contact Spring	P-235869	P-235869	V	Base Terminal Spring	P-235856	P-235856
H	Contact Spring Screw	P-114485	P-114485	X	Key Panel—Red Buttons	542A Key	543A Key
I	Gear	P-235867	P-235867	Y	Key Panel—White Buttons	542B Key	543B Key
J	Gear Mounting Screw	P-119251	P-119251	Z	Key Panel—Black Buttons	541A Key	541A Key
K	Pinion Mounting Screw	P-157519	P-157519	AA	Base—Complete	P-235859	P-235859
L	Pinion	P-235870	P-235870		Cover	P-235843	P-235843
M	Designation Card	P-244445	P-244445		Circuit Label	P-244441	P-244442
N	Window	P-235883	P-235883				
O	Terminal	P-124619	P-124619				

RAILWAY TRAIN DISPATCHING TELEPHONE SYSTEMS

Selector Keys (Continued)

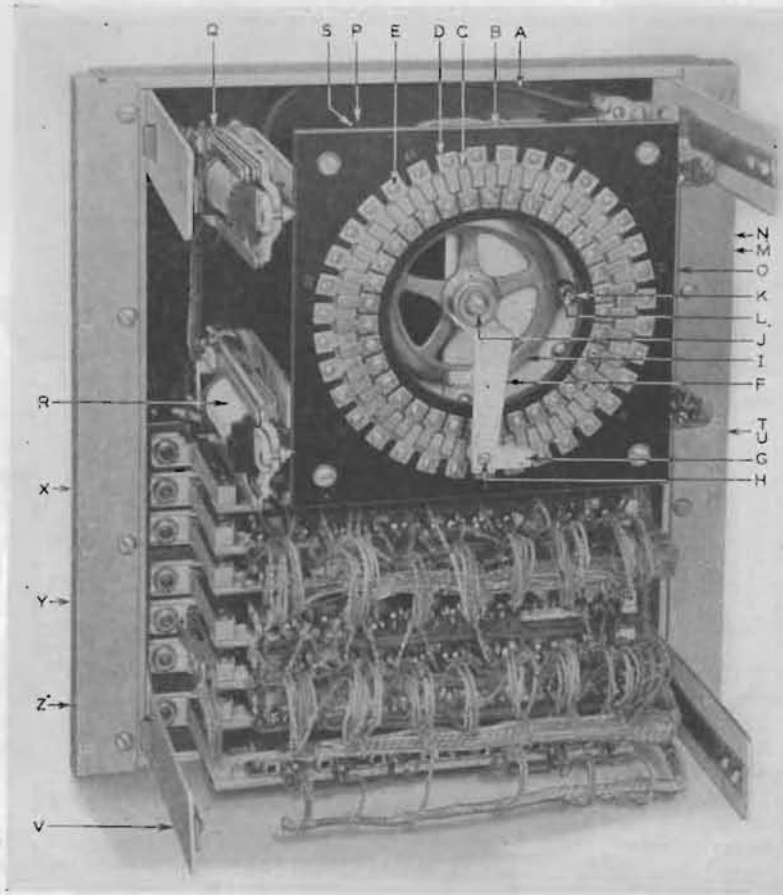

63 Type Selector Key

Symbol	Subject	63A Selector Key	63B Selector Key	Symbol	Subject	63A Selector Key	63B Selector Key
A	Distributor Panel, Complete	P-235880	P-235880	P	Resistance—Ward Leonard	Type O— 45 Ohms	Type O— 45 Ohms
B	Terminal Plate, Complete	P-235864	P-235864	Q	Relay—Start	R-1027	R-1027
C	Inner Segment	P-235866	P-235866	R	Relay—Stop	R-332	R-332
D	Outer Segment	P-235865	P-235865	S	Telechron Motor— Type B3, 1 RPS	60 cycles 22 volts	60 cycles 22 volts
E	Segment Screw	P-115586	P-115586	T	Lamp	No. 2F	No. 2F
F	Contact Arm	P-235868	P-235868	U	Lamp Socket	No. 13A	No. 13A
G	Contact Spring	P-235869	P-235869	V	Cover Support	P-235850	P-235850
H	Contact Spring Screw	P-114485	P-114485	X	Key Panel—Red Buttons	542A Key	543A Key
I	Gear	P-235867	P-235867	Y	Key Panel—White Buttons	542B Key	543B Key
J	Gear Mounting Screw	P-119251	P-119251	Z	Key Panel—Black Buttons	541A Key	541A Key
K	Pinion Mounting Screw	P-157519	P-157519		Cover	P-235842	P-235842
L	Pinion	P-235870	P-235870		Circuit Label	P-244443	P-244444
M	Designation Card	P-244445	P-244445				
N	Window	P-235883	P-235883				
O	Terminal	P-124619	P-124619				

RAILWAY TRAIN DISPATCHING TELEPHONE SYSTEMS

Selector Key Cases



No. 60E Selector Key Case



No. 60A Selector Key Case

Code No.	Capacity Keys	Description	Dimensions
60A	24	Cabinet for mounting No. 60 Type Selector Keys. Four rows of six keys per row. Woodwork golden oak finish.	12 ³ / ₄ in. x 15 ¹ / ₄ in. x 5 ⁵ / ₈ in.
60B	36	Cabinet for mounting No. 60 Type Selector Keys. Four rows of nine keys per row. Woodwork golden oak finish.	12 ³ / ₄ in. x 21 ¹ / ₄ in. x 5 ⁵ / ₈ in.
60C	48	Cabinet for mounting No. 60 Type Selector Keys. Four rows of twelve keys per row. Woodwork golden oak finish.	12 ³ / ₄ in. x 27 ¹ / ₄ in. x 5 ⁵ / ₈ in.
60D	60	Cabinet for mounting No. 60 Type Selector Keys. Four rows of fifteen keys per row. Woodwork golden oak finish.	12 ³ / ₄ in. x 33 ¹ / ₄ in. x 5 ⁵ / ₈ in.
60E	12	Cabinet for mounting No. 60 Type Selector Keys. Three rows of four keys per row. Woodwork golden oak finish.	12 ³ / ₄ in. x 5 ⁵ / ₈ in. x 5 ⁵ / ₈ in.

Selector Key Spaces

Code No.	Description	Used In
50A	Key spaces, black finish.	Nos. 50A, B and C, and Nos. 60A, B, C, D and E Selector Key Cases in spaces not equipped with keys.

Selector Sets

The following selectors and associated apparatus are the older type DC and are listed for convenience in ordering sets for maintenance and extensions to existing circuits:

Code No.	Equipment	Dimensions	Used At
*101A	Box equipped with: 1 No. 101402 Bell. 2 No. 51F Retardation Coils. 1 No. 21U Condenser. 1 No. 1F Resistance. 1 No. 50A Selector.	13 ³ / ₄ in. x 9 ¹ / ₄ in. x 6 ¹ / ₄ in.	Way stations on train dispatching circuits operated on central energy basis.
*101B	Same as No. 101A, except equipped with No. 50B Selector.		
**102A	Box equipped with: 1 No. 101404 Bell. 2 No. 51F Retardation Coils 1 No. 5G Resistance. 1 No. 50A Selector. Arranged for, but not equipped with two dry cells.	19 ³ / ₄ in. x 9 ¹ / ₄ in. x 6 ¹ / ₄ in.	Way stations on train dispatching circuits operated on local battery basis.

RAILWAY TRAIN DISPATCHING TELEPHONE SYSTEMS

Selector Sets (Continued)

	Equipment	Dimensions	Used At
**102C	Similar to No. 102A		
**102C	Similar to No. 102Z. 1 No. 50C Selector. 1 No. 101404 Bell. 1 No. 190M Relay. 1 No. 5G Resistance. 2 No. 51F Retardation Coils. 1 Special No. 43 Retardation Coil.	19¾ in. x 9¼ in. x 6¼ in.	Way stations on train dispatching circuits operated on local battery basis.

*Nos. 101A and 101B Sets are arranged for, but not equipped with, two No. 34A Resistances.

**Nos. 102A and 102C Sets are arranged for but not equipped with, one No. 34A Resistance. These resistances are ordered separately in accordance with the circuit requirements.

AC Selector Sets

RECOMMENDED FOR ALL NEW INSTALLATIONS



No. 160C Selector Set Equipped with No. 60 Type Selector

Code No.	Equipment	Dimensions	Used At
160C	Metal Box equipped with: 1 No. 60CG Ringer. 1 No. 138B Condenser. 1 No. 141H Condenser.	13 in. x 7 in. x 5½ in.	Way stations on AC train dispatching and message circuits when condensers are desired in the selector circuit. For use with No. 60AP or BP Selector. Replaces Nos. 160AC and BC Selector Sets.
160R	Metal Box equipped with: 1 No. 60CG Ringer. 1 No. 141H Condenser.	13 in. x 7 in. x 5½ in.	Same as No. 160C except it is used when selectors are operated through repeating coils. For use with No. 60AP or BP Selector. Replaces Nos. 160AR and BR Selector Sets.

* **Note:** The Nos. 160C and 160R Selector Sets consist of a housing and the necessary associated apparatus and wiring for mounting a No. 60AP or BP Selector. The selector, however, is not furnished as a part of the set and must be ordered separately.

161A	Wooden Box equipped with: 1 No. 60AP Selector 1 No. 47A Repeating Coil. 2 No. 21AB Condensers. 1 No. 21U Condenser. 2 No. 51F Retardation Coils. 1 No. 60C Ringer. 2 No. 26A Gongs.	6½ in. x 9¼ in. x 17 in.	Way stations in intercall circuits with No. 61A Selector Apparatus Case and No. 61A Selector Key.
------	--	--------------------------	---

RAILWAY TRAIN DISPATCHING TELEPHONE SYSTEMS SWITCHES



No. 1B Foot Switch



No. 1A Foot Switch Attachment

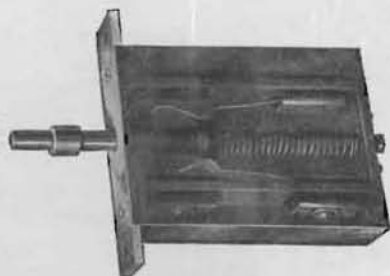

No. 1A Booth Switch

Booth Switch

Description

Code No.

1A For disconnecting siding telephones from the line when the telephone is located in a locked booth. Operates when hasp is placed over the staple and held in place by padlock.

Foot Switches

Code No.

	Springs	Used
1B	Makes one contact.	In dispatcher's telephone set.
3B	Makes two and breaks one contact.	In way station telephone sets.
3C	Makes three and breaks two contacts.	In way station telephone sets with No. 501B Desk Set Boxes.
3D	Makes four and breaks two contacts.	In towers with No. 501B Desk Set Boxes and No. 6052A Amplifier.

Foot Switch Attachments

Use and Description

Code No.	Length Inches	
1A	12	With all types foot switches.
1B	24	With all types foot switches.
2A	23	A $\frac{3}{4}$ inch black enameled conduit equipped with a $\frac{3}{4}$ inch T. & B. bushing (List No. 97760) at one end also includes pipe strap No. 97295 and two wooden screws for mounting. Used to protect wires entering foot switches.

Switchhooks

SPRING ARRANGEMENTS

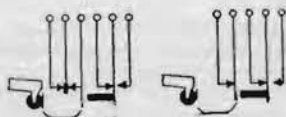

No. 140AG, Nos. 143AA & AC Switchhooks



Nos. 140S, 143J, Nos. 140W and Y and AE, 143AB and 143AB Switchhooks



No. 143Y Switchhook

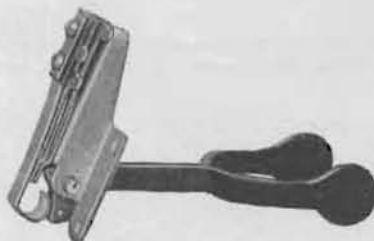

No. 140S Switchhook

RAILWAY TRAIN DISPATCHING TELEPHONE SYSTEMS

Switches (Continued)

Code No.	Description
140S	Black finished, self contained switchhook. See illustration for spring arrangement.
140W	Black finished. Similar in design to No. 140S. See illustration for spring arrangement.
140AG	Black finished. Similar in design to No. 140S. See illustration for spring arrangement.
143J	Black finished, self contained switchhook. All parts treated to effectively resist the action of moisture and fumes. See illustration for spring arrangement.
143Y	Same as No. 143J except not moisture-proofed.
143AA	Black finished, self contained switchhook. Similar in design to No. 143Y. See illustration for spring arrangement.
143AB	Black finished. Similar in design to No. 143Y. See illustration for spring arrangement.
143AC	Black finished, self contained switchhook. For use with the head band type of receiver. See illustration for spring arrangement.
143AE	Black finished. Similar in design to No. 143AC. See illustration for spring arrangement.

Push Button

Code No.	Description	Used In
1003A	Breaks one and makes two contacts	Nos. 1293AD, AE, AK, AL, 1317W, AD, AE, AW and 1336F Telephone Sets.
1006A	Breaks one and makes one contact.	No. 1317BA Telephone Set.
1013A	One break before make and one break before two make contacts are operated.	No. 1317BU Telephone Set.
1014A	One set of break before make-make contacts and one set of break before make contacts.	No. 501A Subscriber Set.

RAILWAY TRAIN DISPATCHING TELEPHONE SYSTEMS

TELEPHONE SETS



No. 1278G Telephone Set

No. 1293AD Telephone Set

No. 1305AC Telephone Set

NOTE: Batteries are not supplied with telephone sets and should be ordered separately.

Code No.	Description
1278G	Weatherproof metal set particularly adapted for street railway service. Five bar AC generator and 1000 ohm unbiassed ringer. Includes: 1 No. 48C Generator 1 No. 25E Repeating Coil. 1 No. 29 Induction Coil. 2 No. 1 Protector Blocks. 2 No. 2 Protector Micacs. 2 No. 2 Protector Micas.
1293AD	Small wall telephone set, having the battery mounted separately. Provided with high efficiency transmission circuit. For use as siding telephone on train dispatching circuits. Employs push buttons for use when talking. Contains: 1 No. 4BG Ringer. 1 No. 21AA Condenser. 1 No. 29 Induction Coil. 1 No. 51A Retardation Coil. 1 No. 1003A Push Button for $\frac{3}{8}$ in. mounting

2 500 volt, 1 ampere Fuses.
 1 No. 5B Lock.
 1 Door Switch for opening circuit when door is closed.
 1 Special No. 51AG Ringer.
 1 No. 1001H Hand Set.
 2 Dry Cells furnished only when ordered.
 1 No. 143AA Switch Hook for $\frac{1}{2}$ in. mounting.
 1 No. 3E Transmitter Bracket.
 1 No. 508 Receiver with 2 ft. No. 446 Cord.
 1 No. 349 Transmitter.
 2 No. 329 Cords, 6 in.



No. 1312A Telephone Set

Code No.	Description
1293AE	For use on sidings. Contains: 1 No. 349 Transmitter 1 No. 186 Receiver. 1 No. 546 Cord, 2 ft. long. 1 No. 4BG Ringer. 1 No. 21AA Condenser. 1 No. 143AC Switchhook.
1293AK	Same as the No. 1293AD, less ringer.
1293AL	Same as the No. 1293AE, less ringer.
1293BC	A high efficiency wall type central battery telephone set designed for use on lines where a large number of sets are required. Black finished. Contains: 1 No. 3E Transmitter Bracket. 1 No. 21AL Condenser. 1 No. 42 Induction Coil. 1 No. 1013A Push Button. 1 No. 143AE Switchhook.
1305AC	Code ringing, insulated magneto set intended to be used on railroads in block and other miscellaneous circuits. Arranged so that a condenser can be connected in the receiver circuit if desired. Consists of: 1 No. 45BG Ringer. 1 No. 48S Generator (insulated crank) 1 No. 3B Transmitter Bracket per D-6169. 1 No. 144 Receiver.
1312A	Standard wall type composite telephone set. Contains: 1 No. 12G Retardation Coil. 1 No. 21D Condenser. 1 No. 21U Condenser. 1 No. 21H Condenser. 1 No. 143AB Switchhook. 1 Special No. 390B Key. 1 No. 1C Howler. 1 No. 5 Induction Coil. 1 Interrupter P-101495. 1 $2\frac{1}{2}$ ft. No. 521 Receiver Cord. 1 No. 604A Transmitter. 1 No. 144 Receiver.
6023A	Desk type composite telephone. Consists of: 1 No. 311A Desk Set Box. 1 No. 1040U Desk Stand. 1 No. 8D Connecting Block. 1 No. 465A Key

RAILWAY TRAIN DISPATCHING TELEPHONE SYSTEMS

Telephone Sets (Continued)



No. 1317 Telephone Set (Closed)



No. 1317 Telephone Set (Open)

Code No.	Description
1317P	Local battery wall telephone for heavily loaded lines where code ringing is employed. Contains: 1 No. 323 Transmitter. 1 No. 144 Receiver. 1 No. 521 Receiver Cord, 2½ ft. 2 No. T1A Cords, 6 in. 1 No. 13 Induction Coil. 1 No. 38BG Ringer. 1 No. 48A Generator. 1 No. 143Y Switchhook. 2 No. 540 Cords. 1 No. 8A Transmitter Bracket.
1317S	Same as No. 1317P, excepting that a No. 21W Condenser is wired in series with the receiver.
1317W	Wall type telephone set for use on standard railway dispatcher's telephone circuits at sidings and similar places for use of conductors and trainmen. Provided with high efficiency transmission circuit. Employs push button for use when talking. Five bar AC generator and 2500 ohm unbiassed ringer. Contains: 1 No. 48A Generator. 1 No. 38BG Ringer. 1 No. 21AA Condenser. 1 No. 29 Induction Coil. 1 No. 51A Retardation Coil. 1 No. 8A Transmitter Bracket. 1 No. 143AA Switchhook. 1 No. 1003A Push Button for ½ in. woodwork. 1 No. 446 Receiver Cord, 2 ft. 1 No. 349 Transmitter. 1 No. 508 Receiver. 2 No. T1A Cords, 6 in. 2 No. 540 Cords.
1317AD	Same as No. 1317W Telephone Set, excepting No. 38BG Ringer is omitted. Can be equipped with No. 38 Type Ringer if desired.
1317AE	Same as No. 1317W Telephone Set, excepting No. 38BG Ringer is omitted and set is equipped with head receiver.
1317AH	Wall type local battery telephone for moderately loaded lines where code ringing is employed. Three bar AC generator and 1000 ohm unbiassed ringer. Contains: 1 No. 22A Generator. 1 No. 38AG Ringer. 1 No. 143Y Switchhook. 1 No. 13 Induction Coil. 1 No. 8A Transmitter Bracket. 1 No. 521 Cord, 2½ ft. 1 No. 323 Transmitter. 1 No. 144 Receiver. 2 No. T1A Cords, 6 in. 2 No. 540 Cords.
1317AW	Same as No. 1317W, excepting that it is equipped with: 1 No. 143AC Switchhook for ½ in. mounting. 1 No. 186 Head Receiver. 2 No. 546 Receiver Cords.
1317BK	For use on telephone lines exposed to high tension wire. Ringer is omitted and generator handle is insulated. All metal parts arranged for grounding. Contains: 1 No. 359 Transmitter. 1 No. 144 Receiver. 1 No. 521 Cord, 2½ ft. 2 No. 540 Cords. 2 No. T1A Cords, 6 in. 1 No. 21W Condenser. 1 No. 13 Induction Coil. 1 Special No. 48R Generator per D13730. 1 Switchhook D19513 for ½ in. woodwork. 1 No. 8A Transmitter Bracket.
1317BU	A highly efficient telephone set designed for use on lines where a large number of sets are required. For use primarily in railroad work and employs a head band receiver. Contains: 1 No. 42 Induction Coil. 1 No. 21AL Condenser. 1 No. 143AE Switchhook for ½ in. woodwork. 1 No. 1013A Push Button for ¾ in woodwork. 1 Special No. 48A Generator. 1 No. 349 Transmitter. 1 No. 189 Receiver. 1 No. 516 Cord, 2 ft. 2 No. T1A Cords, 6 in. 2 No. 540 Cords. 1 No. 8A Transmitter Bracket.

RAILWAY TRAIN DISPATCHING TELEPHONE SYSTEMS

Telephone Sets (Continued)

Code No.	Description
1317CN	For use on medium loaded code ringing lines. Arranged for two cells of dry batteries. Contains: 1 No. 143Y Switchhook for $\frac{1}{2}$ in. woodwork. 1 No. 13 Induction Coil. 1 No. 8A Transmitter Bracket. 1 Special No. 53FG Ringer. 1 No. 323 Transmitter. 1 No. 144 Receiver. 1 No. 521 Cord, $2\frac{1}{2}$ ft. 1 No. 540 Cord. 2 No. T1A Cords, 6 in. 1 Special No. 50F Generator.
1317CG	Same as No. 1317CN, except furnished with No. 53AG Ringer. For use on lightly loaded lines, code ringing.
1317CP	Same as No. 1317CN, except furnished with a Special No. 53BG Ringer (2500 ohms). For use on heavily loaded lines, code ringing.
1317CR	Same as No. 1317CN, except equipped with a Special No. 40F Generator and a Special No. 21W Condenser in the receiver circuit.
1317CS	Same as No. 1317CP, except equipped with No. 21W Condenser in receiver circuit.
1317DU	Same as No. 1317BU, except No. 48 type Generator is omitted.

Portable Telephone Sets



No. 1314A Portable Set



No. 1314A Set Open front view)

Code No.	Description
1314A	Portable composite telephone set. Contains: 1 No. 12M Retardation Coil. 1 No. 140F Switchhook. 1 Special No. 390 Key per D11567. 1 No. 21D Condenser. 1 No. 21U Condenser. 1 No. 21H Condenser. 1 No. 1B Howler. 1 No. 3B Binding Post. 3 Special No. 3C Binding Posts per D51199 1 No. 384 Cord, 3 ft. 1 No. 179 Cord, $8\frac{1}{2}$ in. 1 No. 267 Cord with rail clamp, 10 ft. 1 No. 5 Induction Coil. 1 Interrupter P101495. 1 No. 606A Transmitter 1 No. 133 Receiver.

Arranged for but not equipped with four standard dry batteries unless specified in order. The weight of the set complete is about 26 lbs. Approximate dimensions $11\frac{1}{2} \times 12 \times 7\frac{1}{2}$ inches. No. 4 Line Pole used but should be ordered separately.



No. 1330E Telephone Set



No. 1330F Portable Set

RAILWAY TRAIN DISPATCHING TELEPHONE SYSTEMS

Portable Telephone Sets (Continued)

Code No.	Description										
1330E	<p>Portable railway magneto telephone set. For use on long heavily loaded lines. Used with Nos. 3 or 5 Line Poles. Five bar AC generator and 2500 ohm biased ringer. Contains:</p> <table border="0"> <tr> <td>1 Special No. 48A Generator.</td> <td>1 No. 540 Cord.</td> </tr> <tr> <td>1 No. 32BG Ringer.</td> <td>2 Special No. 2C Binding Posts.</td> </tr> <tr> <td>1 No. 21F Condenser.</td> <td>2 Dry Cells furnished when specified in order.</td> </tr> <tr> <td>1 No. 29 Induction Coil.</td> <td></td> </tr> <tr> <td>1 No. 1001C Hand Set.</td> <td></td> </tr> </table> <p>The weight of the set complete is about 28 lbs. The size is 12¼ x 13¼ x 5¼ inches.</p>	1 Special No. 48A Generator.	1 No. 540 Cord.	1 No. 32BG Ringer.	2 Special No. 2C Binding Posts.	1 No. 21F Condenser.	2 Dry Cells furnished when specified in order.	1 No. 29 Induction Coil.		1 No. 1001C Hand Set.	
1 Special No. 48A Generator.	1 No. 540 Cord.										
1 No. 32BG Ringer.	2 Special No. 2C Binding Posts.										
1 No. 21F Condenser.	2 Dry Cells furnished when specified in order.										
1 No. 29 Induction Coil.											
1 No. 1001C Hand Set.											
1330F	<p>Same as No. 1330E Telephone Set, except that it is equipped with:</p> <ul style="list-style-type: none"> 1 No. 146 Plug and One 6 ft. No. 509 Cord for making connection with line through No. 186 Jack. <p>Condenser furnished only when specified.</p>										
1331E	<p>A local battery magneto portable railroad telephone set for lightly loaded lines. For use with Nos. 3 or 5 Line Poles three bar AC generator and 2500 ohm buzzer. Contains:</p> <table border="0"> <tr> <td>1 No. 3B 2500 ohm Buzzer.</td> <td>1 No. 1001C Hand Set.</td> </tr> <tr> <td>1 No. 29 Induction Coil.</td> <td>2 No. 2C Binding Posts.</td> </tr> <tr> <td>1 No. 22A Generator.</td> <td>2 No. 790 Eveready dry batteries furnished only when specified in order.</td> </tr> <tr> <td>1 No. 21F Condenser.</td> <td></td> </tr> </table> <p>The weight of the set complete is about 17 lbs. The size is 11½ x 10½ x 4¾ inches.</p>	1 No. 3B 2500 ohm Buzzer.	1 No. 1001C Hand Set.	1 No. 29 Induction Coil.	2 No. 2C Binding Posts.	1 No. 22A Generator.	2 No. 790 Eveready dry batteries furnished only when specified in order.	1 No. 21F Condenser.			
1 No. 3B 2500 ohm Buzzer.	1 No. 1001C Hand Set.										
1 No. 29 Induction Coil.	2 No. 2C Binding Posts.										
1 No. 22A Generator.	2 No. 790 Eveready dry batteries furnished only when specified in order.										
1 No. 21F Condenser.											
1331F	<p>Same as No. 1331E Telephone Set, excepting that it is equipped with:</p> <table border="0"> <tr> <td>1 No. 146 Plug.</td> <td>1 No. 21F Condenser.</td> <td rowspan="2">} If specified on order</td> </tr> <tr> <td>1 No. 509 Cord, 6 ft. long, for making connection to the line through 186 or 187 Jacks.</td> <td>2 No. 790 Batteries.</td> </tr> </table>	1 No. 146 Plug.	1 No. 21F Condenser.	} If specified on order	1 No. 509 Cord, 6 ft. long, for making connection to the line through 186 or 187 Jacks.	2 No. 790 Batteries.					
1 No. 146 Plug.	1 No. 21F Condenser.	} If specified on order									
1 No. 509 Cord, 6 ft. long, for making connection to the line through 186 or 187 Jacks.	2 No. 790 Batteries.										



No. 1332A Portable Set



No. 1375B Portable Set

Code No.	Description						
1332A	<p>Telephone Set in portable leather case with a shoulder carrying strap. For use in connection with Nos. 3 or 5 Line Poles on train dispatching circuits. Contains:</p> <table border="0"> <tr> <td>1 No. 29 Induction Coil.</td> <td>1 No. 1001C Hand Set.</td> </tr> <tr> <td>1 No. 21BW Condenser.</td> <td>2 No. 792 Eveready dry batteries furnished only when ordered.</td> </tr> <tr> <td>2 No. 2C Binding Posts.</td> <td></td> </tr> </table> <p>The complete set weighs approximately 6 lbs. The size is 9½ x 7½ x 4 inches.</p>	1 No. 29 Induction Coil.	1 No. 1001C Hand Set.	1 No. 21BW Condenser.	2 No. 792 Eveready dry batteries furnished only when ordered.	2 No. 2C Binding Posts.	
1 No. 29 Induction Coil.	1 No. 1001C Hand Set.						
1 No. 21BW Condenser.	2 No. 792 Eveready dry batteries furnished only when ordered.						
2 No. 2C Binding Posts.							
1332E	<p>Same as No. 1332A, excepting that it is equipped with a No. 3B 2500 ohm Buzzer.</p>						
1375B	<p>Telephone Set in portable leather case with adjustable hand or shoulder carrying strap. Apparatus moisture-proofed and mounted on an aluminum frame. Contains:</p> <table border="0"> <tr> <td>1 No. 1001H Hand Set.</td> <td>1 Special No. 2150 ohm Buzzer (D21141).</td> </tr> <tr> <td>1 Special No. 31 Induction Coil (D17624).</td> <td>1 No. 703 Eveready Battery.</td> </tr> <tr> <td>1 No. 29E Generator.</td> <td></td> </tr> </table> <p>Complete set weighs approximately 10½ lbs. The size is 9¾ inches high, 3¾ inches deep and 6¾ inches wide. This telephone set can be equipped with the No. 1001G Hand Set where a lighter weight is desired.</p>	1 No. 1001H Hand Set.	1 Special No. 2150 ohm Buzzer (D21141).	1 Special No. 31 Induction Coil (D17624).	1 No. 703 Eveready Battery.	1 No. 29E Generator.	
1 No. 1001H Hand Set.	1 Special No. 2150 ohm Buzzer (D21141).						
1 Special No. 31 Induction Coil (D17624).	1 No. 703 Eveready Battery.						
1 No. 29E Generator.							
1398A	<p>Local battery, portable, moisture-proof, magneto telephone set enclosed in wooden case and equipped with a handle or shoulder strap. Contains:</p> <table border="0"> <tr> <td>1 No. 29E Generator.</td> <td>1 No. 21K Condenser.</td> </tr> <tr> <td>1 No. 31 Induction Coil (D17624).</td> <td>1 No. 703 Eveready Battery.</td> </tr> <tr> <td>1 Buzzer (D21141).</td> <td>1 No. 1001H Hand Set.</td> </tr> </table>	1 No. 29E Generator.	1 No. 21K Condenser.	1 No. 31 Induction Coil (D17624).	1 No. 703 Eveready Battery.	1 Buzzer (D21141).	1 No. 1001H Hand Set.
1 No. 29E Generator.	1 No. 21K Condenser.						
1 No. 31 Induction Coil (D17624).	1 No. 703 Eveready Battery.						
1 Buzzer (D21141).	1 No. 1001H Hand Set.						

RAILWAY TRAIN DISPATCHING TELEPHONE SYSTEMS

Telephone Sets (Continued)

Weatherproof Telephone Sets



No. 1336F Closed



No. 1336F Open

Code No.

Description

- 1336F** An iron box, local battery telephone set for heavily loaded lines for use out of doors on train dispatching circuits. Provided with high efficiency transmission circuit. All parts treated to effectively resist the action of moisture and fumes. Employs push button for use when talking. Five bar AC generator and 2500 ohm unbiased ringer. Contains:
- | | |
|-----------------------------|--|
| 1 No. 48C Generator. | 1 Special No. 1002A Push Button. |
| 1 No. 143K Switchhook. | 1 No. 508 Receiver. |
| 1 No. 45BG Ringer. | 2 No. 385 Transmitter Cords. |
| 1 No. 32 Induction Coil. | 1 No. 384 Receiver Cord, 10½ in. |
| 1 No. 51B Retardation Coil. | 1 No. 540 Cord. |
| 1 No. 601A Transmitter. | 3 ½ x ¾ x 2¼ inch leather cable holders. |
| 1 No. 21AA Condenser. | 2 Dry cells (when specified in the order). |
- 1336H** Circuits are arranged so that it is unnecessary to use a push button for talking. Contains:
- | | |
|-------------------------|----------------------------------|
| 1 No. 144 Receiver. | 1 No. 48C Generator. |
| 1 No. 601A Transmitter. | 1 No. 45BG Ringer. |
| 1 No. 540 Cord. | 1 No. 21AA Condenser. |
| 1 No. 384 Cord, 10½ in. | 1 Special No. 30 Induction Coil. |
| 2 No. 385 Cords, 7 in. | 1 No. 143AA Switchhook. |

RAILWAY TRAIN DISPATCHING TELEPHONE SYSTEMS

TELEPHONE OUTFITS

LOUD SPEAKING

No. 12A Loud Speaking Telephone Outfit

The No. 12A Loud Speaking Telephone Outfit is intended for use in train dispatching circuits at Dispatchers' Stations and consists of:

- 1 No. 519A Subscribers Set.
- 1 No. 216A Vacuum Tube.
- 1 No. 543W Receiver.

Note: A No. 579A Loud Speaking Telephone or a KS6368 Horn with a No. 549 Receiver may be used in place of the No. 543W Receiver in this outfit.

No. 519A SUBSCRIBERS SET

The No. 519A Subscribers Set consists of an oak cabinet 9 $\frac{1}{4}$ inches wide, 16 $\frac{3}{4}$ inches high and 6 $\frac{3}{16}$ inches deep in which is mounted the following apparatus:

- 1 No. 100L Vacuum Tube Socket.
- 1 No. 19DP Resistance.
- 1 No. 19DR Resistance.
- 1 No. 19DN Resistance.
- 1 No. 34H Resistance.
- 1 No. 100A Retardation Coil.
- 1 No. 43 Induction Coil.
- 1 No. 44 Induction Coil.
- 1 No. 218F Input Transformer.
- 2 No. 21AK Condensers.
- 2 No. 21F Condensers.
- 1 No. 21D Condenser.
- 1 No. 272A Key.

The No. 519A Subscribers Set functions similarly to the No. 502A Subscribers Set and in addition is equipped with one stage of amplification which is operated on a direct current power supply. This set operates with a No. 543W Loud Speaking Receiver.

The set is provided with a key to switch in either the loud speaker or a regular dispatcher's head receiver. The amplification is such that satisfactory volume may be obtained over a 200 or 300 mile line (open wire).

DIRECTIONS

Make connections to line, foot switch, jack box, transmitter battery and amplifier "A" and "B" current supplies as indicated. Adjust current through filament of tube to approximate .95 ampere by means of R3 and R4. This current may be measured on an ammeter connected across terminals 13 and 14 with the strap between these two removed. After adjusting current, strap should be replaced. To adjust for loudness connect flexible leads from terminals 20 and 22 across different sections of R1 until desired volume is obtained. Connect flexible lead from terminal 21 across enough of R1 so that when foot switch is operated to talk, the set does not sing and the volume is not too great.

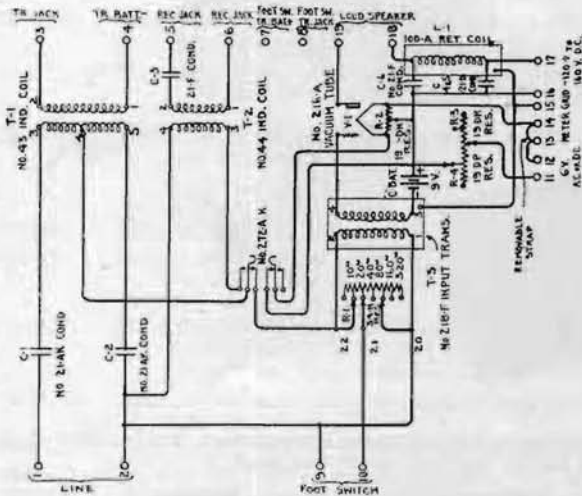

Schematic of No. 519A Subscribers Set

No. 216A VACUUM TUBE

A No. 216A Vacuum Tube is required for this set but is not a part of it. The heating current for the filament of the tube may be derived from either 6 volt AC or DC source of energy. The tubes are sold only with the No. 12A Loud Speaking Telephone Outfit or as a replacing part.

No. 6052A AMPLIFIER.

The No. 6052A Amplifier is used in conjunction with a No. 501B Desk Set Box at Way Stations and with a No. 502A Desk Set Box at Dispatchers' Stations.

No. 6040A AMPLIFIER.

The No. 6040A Amplifier being electrically the same as the No. 6052A except for the frequency of the power source required for its operation, may be used under otherwise identical conditions.

Note: For further information regarding Loud Speaking Telephone Equipment see Page 18.

RAILWAY TRAIN DISPATCHING TELEPHONE SYSTEMS

TIME SENDING SET

No. 60A TIME SENDING SET

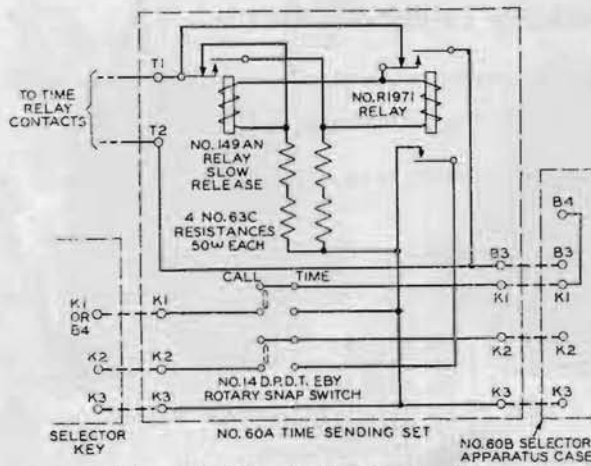

The 60A Time Sending Set is intended for use in conjunction with the 60B Selector Apparatus Case and the time repeating relay at the dispatcher's station, to transmit time impulses over the system so that the bell in each of the way station sets will tap and give a signal corresponding to each closure of the local contact of the time repeating relay.

Consists of a black finished metal surface cabinet containing a black phenol fibre mounting plate on which is mounted the following equipment:

- 1 No. R1971 Relay.
- 1 No. 149AN Relay.
- 1 DPDT Rotary Snap Switch.
- 4 No. 63C Resistances.

Approximate overall dimensions are 6 $\frac{3}{16}$ " wide x 7 $\frac{5}{8}$ " high x 6 $\frac{1}{4}$ " deep.

Entirely replaces the D14386 Time Sending Set.

For further information regarding the operation of this equipment refer to Page 14.

NO. 341A TRANSFORMER



The No. 341A Transformer has a shell type silicon steel core clamped between angle iron brackets which also provide a mounting for the transformer and for the terminal connecting block.

Code No.	No. of Coils	No. of Windings Each Coil	Resistance, Ohms		Approx. Dimensions	Approx. Weight
			Primary	Secondary		
341A	1	4 { 2 Primary 2 Secondary }	90	175	{ 6" x 5 $\frac{5}{8}$ " x 5 $\frac{3}{4}$ " }	20 lbs.

The primary windings and the secondary windings are each balanced from a resistance, inductance and capacity standpoint to within 200 crosstalk units to permit the coil to be used on simplex telephone circuits arranged for duplex telegraph without interference from the telegraph on the side or phantom telephone circuits.

Note: The No. 341A Transformer is especially designed for repeating the low frequency (3 $\frac{1}{4}$ cycles) selector impulses for long lines with a large number of selectors. The impedance at 900 cycles of the two secondary windings connected in series aiding is approximately 6,000 ohms and of the two primary windings in series aiding is approximately 12,000 ohms. The loss from bridging the transformer on a line as a simplex bridge is, therefore, very small. The loss in telephone transmission due to inserting this transformer in the center of an electrically long line of No. 9 B & S non-loaded open copper wire is approximately 5 decibels.

RAILWAY TRAIN DISPATCHING TELEPHONE SYSTEMS

TRANSMITTER ARMS

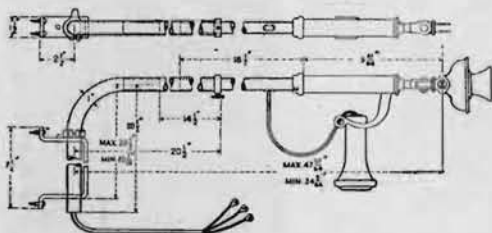

No. 1020CC Trans. Arm

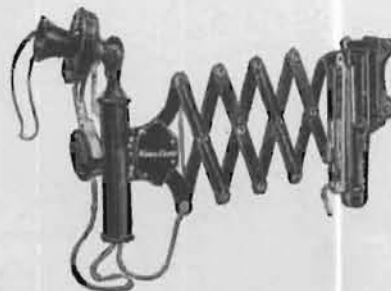

No. 1048DD Trans. Arm

Code No.	Description
1020CC	For regular local or central battery service. Used on flat top desks. Includes: 1 No. 20CC Transmitter Arm. 1 No. 323 Transmitter. 1 No. 144 Receiver.
1020C	For way station use on train dispatching circuits, Includes: 1 No. 20C Transmitter Arm. 1 No. 349 Transmitter. 1 No. 186 Receiver.
1020E	Includes: 1 No. 20E Transmitter Arm. 1 No. 349 Transmitter. 1 No. 186 Receiver.
1048DA	Adjustable folding arm, having telephone set incorporated in it. Mounts on side of a roll top desk. Includes: 1 No. 148DA Transmitter Arm. 1 No. 349 Transmitter.
1048DB	Adjustable folding arm, having telephone set incorporated in it. Mounts on sides of flat top desk or on wall. Includes: 1 No. 148DB Transmitter Arm. 1 No. 349 Transmitter.
1048DC	Same as No. 1048 DA, except mounts on top of flat top desk.
1048DD	Same as No. 1048DA except mounts on wall in way stations where it is desired to place a flat top desk against the wall.
1048GA	Equipped with a No. 349 Transmitter, No. 186 Receiver, No. 416 Cord, 8 ft., No. 554 Cord, 2 1/2 ft., No. 330 Cord, 9 7/8 in. long. Mounts on side of roll top desk.
1048GB	Same as No. 1048GA except mounts on wall or side of flat top desk.
1048GC	Same as No. 1048 GA except mounts on top of flat top desk.
1048GD	Same as No. 1048GA except mounts on wall in way stations where it is desired to place a flat top desk against the wall.
1120C	Transmitter arm same as the No. 1020C except that the 189 Receiver is used instead of the No. 186.
1148DA	Same as No. 1048DA except that it is equipped with low wound No. 189 Receiver.
1148DB	Same as No. 1048DB except that it is equipped with low wound No. 189 Receiver.
1148DC	Same as No. 1048DC except that it is equipped with low wound No. 189 Receiver.
1148DD	Same as No. 1048DD except that it is equipped with low wound No. 189 Receiver.

Train dispatching at way stations with a desk set box employing a four conductor cord and an induction coil having the primary and secondary windings insulated from each other.

Used at way stations with the Nos. 501A and B Desk Set Boxes.

Used with Nos. 501A and B Desk Set Boxes.

Used with Nos. 501A and B Desk Set Boxes.

Used with No. 501A and B Desk Set Boxes.

Used with Nos. 501A and B Desk Set Boxes.

RAILWAY TRAIN DISPATCHING TELEPHONE SYSTEMS

TRANSMITTER ARM BRACKETS

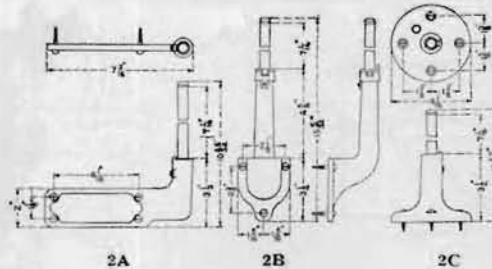

Transmitter Arm Brackets

Code No.	Description	Dimensions, Inches		Use
		Length of Rod	Overall Length	
2A	Consists of an iron base equipped with a steel rod about which the arm rotates	$7\frac{1}{16}$	$10\frac{23}{32}$	Mounts on the side of roll top desks.
2B	Same as the No. 2A except equipped with a collar assembled on the rod for the purpose of stopping the rotation of the transmitter arm in any one of the four predetermined positions.	$7\frac{1}{16}$	$15\frac{3}{32}$	Mounts on wall or side of flat top desks.
2C	Similar to the No. 2A.	$7\frac{1}{16}$	$10\frac{23}{32}$	Mounts on the top of a flat top desk.

TRANSMITTER BRACKETS

Code No.	Description	Use
3E	For mounting insulated transmitters.	Nos. 1293AD, AE, AK, AL and 1305AC Telephone Sets.
8A	Black finish bracket, for mounting transmitters on wooden telephone sets.	Nos. 1317P, S, W, AD, AH, AW, AE, BU, CN, CP, CR, CS and CG Telephone Sets.

TOOLS



No. 48 Tool



No. 144 Tool



No. 115 Tool



No. 145 Tool

Code No.	Description
48	Used for adjusting Nos. 50A and 50B Selectors. Consists of a wrench and screw driver. Will fit $\frac{1}{4}$ inch and $\frac{1}{32}$ inch nuts.
115	Used for changing Nos. 50A and 50B Selectors to call different stations. It is a small double ended tool, one end consisting of a wrench for $\frac{1}{4}$ inch hexagonal nut; the other end a small wire hook.
144	Used for changing Nos. 60A, 60B, 60AP and 60BP Selectors to call different stations. Consists of a socket wrench and screw driver.
145	Used for changing Nos. 60A and 60B Selectors to call different stations. Small double ended tool, one end consisting of a wrench for $\frac{1}{8}$ inch hexagonal nut; the other end a small wire hook.

RAILWAY TRAIN DISPATCHING TELEPHONE SYSTEMS TESTING APPARATUS

Test Sets



No. 60B Test Set



No. 1017 Type Test Set

**Code
No.
60B**

Description

Intended for use in the field for electrically testing No. 60 type Selectors and No. 160 type Selector Sets. Consists of a black finished metal box having a hinged cover and a carrying handle. Contains a fibre panel on which are mounted the following:

- 1 Weston No. 506 Milliammeter.
- 1 Polynet Type VC 1946 Wire Wound Volume Control.
- 3 No. 92 Type Keys.
- 1 No. R323 Relay.
- 1 No. 138B Condenser.
- 3 No. 768 Eveready Batteries required (must be ordered separately).
- 8 Terminal Punchings.

The terminal punchings are provided for use in making external connections to the Nos. 60, 61 or 62 type Selector Keys. An opening in the panel and other means are provided for internally connecting in the test circuit, a No. 60 type Selector Key when it is desired to use this key in this manner for operating the selector under test.

Approximate overall dimensions of the No. 60B Test Set with cover closed, are 8¼" long, 6" deep and 9" high. Approximate weight including batteries 14 lbs.

NO. 1017C TEST SET consists of a wooden box telephone set equipped with a regular battery talking circuit consisting of a standard transmitter, induction coil, receiver and a special three cell dry battery unit. It can be used either on magneto or central battery lines. Will ring through 5,000 ohms. Contains:

**Code No.
1017C**

Description

- | | |
|--------------------------|---|
| 1 No. 2D Buzzer. | 1 No. 703 Eveready Battery
(must be ordered separately). |
| 1 No. 29F Generator. | 1 Special Switch. |
| 1 No. 572 Cord. | 3 No. 3C Binding Posts. |
| 1 No. 13 Induction Coil. | |
| 1 No. 515 Receiver. | |
| 1 No. 266 Transmitter. | |

THE NO. 1017E TEST SET is similar to the No. 1017C except it is equipped for use on either composed or straight telephone lines. Contains:

1017E

- | | |
|--------------------------|---|
| *1 No. 29F Generator. | 1 No. 714 Eveready Battery (must be
ordered separately). |
| 1 No. 2E Buzzer. | 1 No. 572 Cord, 2 ft. |
| 1 No. 515 Receiver. | 1 No. 6000A Interrupter. |
| 1 No. 13 Induction Coil. | |
| 1 No. 266 Transmitter. | |

* This generator will operate a No. 56A Drop through 11,500 ohms resistance.

The above sets have a birch mahogany finish. Size of case, length 6¾", width 4¾" and height 7¾". Weight 7 lbs.

D86418

Similar to a No. 1017E Test Set except that it includes an exploring coil, special switching device, and a modified circuit for controlling the test tone for the exploring coil. This set is intended to fulfill the standard uses for the No. 1017 Type Test Sets and in addition includes a fault direction locating feature for use in testing open wire lines. The No. 515 Receiver and No. 266 Transmitter are required for operation but must be ordered separately.

RAILWAY TRAIN DISPATCHING TELEPHONE SYSTEMS

Testing Apparatus (Continued)



No. 43A Test Set



No. 1020C Test Set

CABLEMAN'S TEST SET

Code No.

Description

43A

Splicer's Portable Test Set. Intended for use in connection with the installation and maintenance of cable in manual or dial telephone areas. Consists of a buzzer circuit which provides tone for identifying wires for balance testing and for running down resistance faults on short non-loaded cable by the exploring coil method; together with auxiliary circuits which provide for a battery for detecting defective pairs by receiver battery tests or for energizing the transmitter of a talking set and a ringer buzzer by means of which the splicer may be called from a central office when communication with him is desired. Woodwork birch, finish olive-green.

Contains:

- | | |
|------------------------|--|
| 10 Binding Posts. | 1 No. 15 Lungen Buzzer, Size No. 2,
wound to 40 ohms. |
| 1 No. 21F Condenser. | 2 No. 771 Eveready Batteries required
(must be ordered separately). |
| 1 No. 21R Condenser. | 1 No. 13 Induction Coil. |
| 1 No. 2D Buzzer. | |
| 2 SPST Snap Switches. | |
| 2 No. 1AG Resistances. | |

1020C

Designed for use by cable repairmen as a portable test set for locating shorts, grounds, crosses, split pairs and wet spots in cables. The case has a birch mahogany finish and weighs 12½ lbs. without batteries. Size 12½" wide, 6⅞" deep and 10⅞" high. Consists of the Nos. 20C and 1019C Test Sets, the latter being contained in the case of the former:

THE NO. 1019C TEST SET consists of the No. 19C Test Set equipped with one No. 747 Cord, one No. 186 Plug and one No. 528 Receiver.

THE NO. 19C TEST SET consists of an exploring coil, a condenser and three jacks enclosed in a nickel silver case.

THE NO. 20C TEST SET consists of the following apparatus:

- | | |
|------------------------|---|
| 3 No. 540 Cords | 1 Interrupter. |
| 1 No. 18AC Resistance. | 1 2-Point Switch. |
| 1 No. 21K Condenser. | 4 Dry Cells (must be ordered separately). |
| 1 Vibrator. | |

1120C

This Test Set is the same as the No. 1020C Test Set except that it contains a No. 1119C Test Set instead of a No. 1019C.

THE NO. 1119C TEST SET consists of a No. 19C Test Set equipped with one No. 584 Cord, one No. 186 Plug, one No. 1A Headband and two No. 502 Receivers.

SWITCHING AND TESTING PANELS

We are prepared to furnish switching and testing panels to take care of any requirements. These panels are equipped with switches and are used for testing and patching purposes on train dispatching and simplex block circuits.

Prices furnished on request.

RAILWAY TRAIN DISPATCHING TELEPHONE SYSTEMS TRANSMITTERS



No. 323 Transmitter



Head Telephone Set with No. 386 Transmitter



No. 285 Transmitter

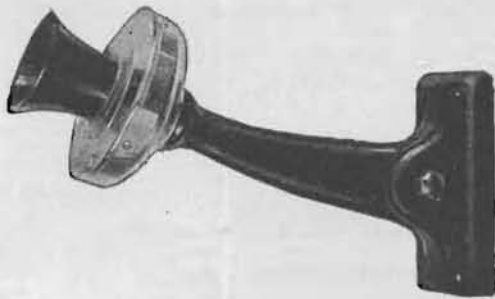

No. 353 Transmitter

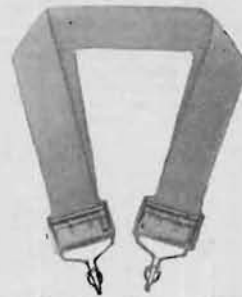

No. 3A Transmitter Attachment

Code No.	Description	Used
244	An insulated high resistance nickel finish transmitter. Consists of a cylindrical brass case with a perforated metal mouth piece and an inner case. Provided with No. 16 Button.	With No. 1001H Hand Set, Nos. 1278G, H and 1375B Telephone Sets.
266	An insulated high resistance nickel finish transmitter, provided with aluminum punch cover, but without a mouth piece so that it can be mounted inside of a box. Cords enter through brass bushing on the lower side. Equipped with No. 9 Button.	Used in Nos. 1017C and E Tests Sets.
285	An insulated low resistance transmitter similar to the No. 244. Uses a special No. 16 Button. Nickel.	On No. 1001C Hand Set, Nos. 1330E, F, 1331E, F, 1332A, and E Portable Telephone Sets.
323	A high resistance insulated black finished transmitter, provided with mounting lug and clamping bolt. Replaces Nos. 291W 317W and 329W Transmitters.	On Nos. 1317P, S, AH, AW, BK, CG, CN, CP, CR, CS, DU and 6023A Telephone Sets; Nos. 1020AL, U, 1040AL and U Desk Stands; and No. 1020CC Transmitter Arm.
349	An insulated black finished transmitter similar to the No. 323 except that it is equipped with a low resistance button. Replaces No. 280W, also No. 284W except for replacement purposes.	With Nos. 1293AD, AE, AK, AL, BC, 1317W, AD, AE and BU Telephone Sets; Nos. 1020C, E, 1048DA, DB, DC, DD, GA, GB, GC, GD, 1120C, 1148DA, DB, DC, and DD Transmitter Arms; Nos. 1042AB, BR and 1142AB Desk Stands.
353	A high resistance insulated bracket type transmitter. Equipped with two T1A Cords, 9 1/8 inches. Case, bracket and arm finished in black. Replaces No. 350 Transmitter.	Magneto and central battery wall telephones, requiring insulated bracket type transmitter such as No. 1317BK Telephone Set.
359	A centrally damped transmitter similar to No. 323 except it is equipped with a reinforced mouthpiece.	With No. 1305AC Telephone Set.
386	A low resistance insulated aluminum centrally damped local battery chest transmitter. Replaces No. 283 Transmitter.	With No. 375 Cord in dispatcher telephone sets.
601A	An insulated, low resistance, centrally damped, granular carbon transmitter equipped with a reinforced composition mouth piece and a black finished bell having a flat back arranged to mount on a transmitter bracket in the No. 336 Type Subscriber Set. Replaces No. 292W Transmitter.	With the Nos. 1336F and H Telephone Sets.
603A	A black finished, centrally damped, insulated, low resistance, granular carbon transmitter unit mounted on a short black finished hollow transmitter arm which is in turn pivoted to a bracket in such a manner that the transmitter may be swung in a vertical plane. The transmitter unit is equipped with a reinforced mouth piece. Two No. 323 Cords, 8' long are connected to the transmitter terminals. Replaces No. 282W Transmitter.	Railway train dispatching systems.

RAILWAY TRAIN DISPATCHING TELEPHONE SYSTEMS

Transmitters (Continued)

Code No.	Description	Used
604A	Consists of a No. 354 type high resistance Transmitter mounted on a black finished hollow transmitter arm which is in turn pivoted to a bracket in such a manner that the transmitter can be swung in a vertical plane. Two No. 356 Cords pass through the transmitter arm with the cord tip ends connected to the transmitter terminals and the other end soldered to terminals in the back of the bracket. Replaces No. 286W Transmitter.	With No. 1312A Telephone Sets.
605A	A centrally damped, insulated, low resistance, granular carbon transmitter, having a nickel finished brass bell and a face plate of polished aluminum. Horn mouth piece. Arranged to mount on transmitter arms. Replaces No. 287W Transmitter.	Railway train dispatching systems.
606A	A black finished, centrally damped, insulated, high resistance, granular carbon transmitter. Equipped with a reinforced mouth piece and a bell having no lug and arranged to mount on transmitter arms. Replaces No. 228W Transmitter.	With the No. 1314A Telephone Set and Railway Train Dispatching Systems.
607A	Consists of a No. 606 type Transmitter mounted on a black finished transmitter arm, which is in turn pivoted to a bracket in such a manner that the transmitter may be swung in a vertical plane. A No. 13 Induction Coil is mounted in the bracket on which four insulated terminals and one grounded terminal are mounted. Leads from the four terminals of the induction coil are connected to the four insulated terminals on the bracket. Replaces No. 259 W Transmitter.	Railway Train Dispatching Systems.

TRANSMITTER ATTACHMENTS

Used for supporting chest type transmitter

Code No.	Description	Code No.	Description
2A	Buckle only.	3B	Buckles and black colored tape.
3A	Buckles and slate colored tape.	3C	Buckles and white colored tape.

RAILWAY TRAIN DISPATCHING TELEPHONE SYSTEMS

BATTERIES AND SUPPLIES

Dry Batteries for Telephone Service



Gray Label

COLUMBIA GRAY LABEL DRY CELLS

This battery is specially designed for telephone work. It is noted for its long life and satisfaction on light-drain service. A patented Eveready feature—the new metal top protects against leakage, bulging and breakage. Made in 6 inch size only. Fahnestock Spring Binding Posts are furnished without extra charge when requested.



Long Life

EVEREADY EXTRA LONG LIFE TELEPHONE CELLS

It is the longest lasting battery manufactured for telephone work. The many hours of extra service obtained from this battery more than compensates for its slight extra cost. It has the new metal seal top—all armored construction. Made in 6 inch size only.

DESCRIPTION

Type	Voltage	Diameter Inches	Height Inches	Approx. Weight of Standard Packages lbs.	Quantity in Standard Package
Columbia Gray Label Telephone	1½	2½	6	56	25
Eveready Long Life Telephone	1½	2½	6	57	25



Eveready Columbia

EVEREADY COLUMBIA DRY CELLS

Eveready Columbia No. 6 Dry Cell with the new Metal Top—a patented Eveready feature—protects against leakage, bulging and breakage. Renowned for its long life and excellent service for all Dry Cell uses. Its exceptionally long life and quick recuperation have made the Eveready No. 6 Dry Cell famous for ignition, radio and other heavy duty service. It is the best general purpose dry cell. Made in 6 inch size only.

DESCRIPTION

Type	Voltage	Diameter Inches	Height Inches	Approx. Weight of Standard Packages lbs.	Quantity in Standard Package
Eveready Columbia Dry Cell	1½	2½	6	57	25

OVAL COLUMBIA BATTERIES FOR PORTABLE TELEPHONES

For Use With Portable Telephones

This Cell is equipped with Screw Binding Posts

List No.	Size of Zinc Cans Inches	Weight Per Cell Ozs.
04	1¼ x 2¼ x 4	11¼

EVEREADY FLASHLIGHT BATTERIES

Size Overall

List No.	No. of Cells	Height Ins.	Width Ins.	Depth Ins.	Standard Package	Used
703	3	2 ¹³ / ₃₂	2 ⁷ / ₁₆	²⁷ / ₃₂	10	In the Nos. 1017B, C, E Test Sets and No. 1375B Telephone Set.
790	2	4 ¹³ / ₁₆	1 ¹¹ / ₃₂	—	120	In the Nos. 1330E, F, 1331E and F Telephone Sets.
792	2	2 ²¹ / ₃₂	1 ²¹ / ₃₂	²⁷ / ₃₂	1	In the Nos. 1332A and E Telephone Sets.

RAILWAY TRAIN DISPATCHING TELEPHONE SYSTEMS

Batteries and Supplies (Continued)

Complete Cell



Cell in Tray



Complete Renewal

EDISON PRIMARY BATTERIES AND RENEWALS

GENERAL

Edison Primary Batteries are furnished in capacities ranging from 75 to 1000 ampere hours. The 75, 250 and 500 ampere hour cells are the sizes best adapted to telephone work.

The characteristics of this battery, which make it particularly well suited for telephone service, are: uniform voltage under continuous discharge; extremely low and constant internal resistance; freedom from depreciation when the circuit is open; long life, with no attention between renewals; indicator panels in plates, which accurately show the approach of exhaustion, thus making it possible to maintain a circuit indefinitely without battery failure; immunity from polarization when continually discharged at or below recommended rates. Each cell consists of the following:

Permanent Parts

Jar, heat resisting glass.
Porcelain cover.
Set of terminal nuts and washers.

Active Materials

Assembled Element (Electrodes).
Can of Caustic Soda.
Bottle of special battery oil.

For initial installations, complete cells are ordered which include all of the parts listed above. When a cell exhausts, the active materials (elements, caustic soda and oil) only are required, the permanent parts being continued in service indefinitely. The active materials are designated as a renewal by means of which an exhausted cell is restored to its original capacity.

Special heat resisting glass jars are used with Edison Primary Cells. These jars, which were developed for use with this form of battery, withstand the variations in temperatures to which they are subjected when the electrolyte is being mixed and are not affected by the solution. They make for convenience in checking the condition of the elements and solution lines.

The open circuit voltage of all Edison Primary Cells when new is 0.9. The closed circuit voltage is very constant and ranges from 0.6 to 0.65 depending on the rate of discharge and the degree of exhaustion.

Type S75
CellType S252
CellType S502
CellType S504
Cell

Type S-75 Cell

The type 75 cell meets the demand for a small cell of dependable capacity, capable of delivering comparatively strong currents, practically free from shelf depreciation and selling at a low price. Inexpensive jars of ordinary glass are used and the entire cell is discarded at exhaustion. The overall dimensions are 3 inches in diameter by 7½ inches high.

RAILWAY TRAIN DISPATCHING TELEPHONE SYSTEMS

*Batteries and Supplies (Continued)***Type S-75**

The maximum recommended continuous current is 0.65 ampere. Maximum recommended intermittent current, 1 ampere. The type 75 is a highly efficient telephone cell and is also suitable for any service where the current requirements come within the recommended discharge limits. For voltage see general descriptive matter.

Type S-252 Cell

This cell is used extensively in railway telephone service for dispatchers and way station transmitters; in many cases the way station transmitter battery also supplies the current for selective ringing. It is a particularly well balanced cell, as regards relation of electrodes to electrolyte, with the element carried high in the jar and clear of the dense solution at the bottom of the cell.

The maximum recommended current is as follows: continuous 1 ampere, intermittent 1.5 amperes. For voltage see general descriptive matter.

Capacity 250 ampere hours.
Rectangular heat resisting glass jar.
Size overall, $3\frac{3}{8} \times 5\frac{7}{8} \times 12$ inches.
Jar only, inside, $2\frac{7}{8} \times 5\frac{1}{4} \times 10$ inches.

Description

Type S-252 Cell Complete.
Type S-250 Renewal Complete.

Separate Parts

Type 252 Jar.
Type 252 Cover.
Wing Nuts and Washers per set.
Type S-250 Element.
Type 250 Caustic Soda, per can.
Type 250 Oil, per bottle.

Type S-502 and S-504 Cells

These cells have a capacity of 500 ampere hours and are furnished with either rectangular shaped jars (S-502) or barrel shaped jars (S-504). They are recommended for the dispatcher's and busy way station transmitters, the operators transmitter on magneto switchboards, interrupters and pole-changers, private branch exchanges, inter-communicating systems, etc. They provide the most economical battery for circuits that consume 500 ampere hours in two years or less, the cost of active materials, per unit of energy, being extremely low.

The maximum recommended continuous current is 2 amperes. Maximum recommended intermittent current is 3 amperes. For voltage see general descriptive matter.

Type S-502 Cell

Capacity 500 ampere hours.
Rectangular heat resisting glass jar.
Size overall, $5\frac{3}{4} \times 6\frac{3}{4} \times 12\frac{1}{4}$ inches.
Jar only, inside dimensions $5 \times 6 \times 10$ inches.

Description

Type S-502 Cell.
Type S-500 Renewal.

Separate Parts

Type 502 Jar.
Type 502 Cover.
Wing nuts and washers, per set.
Type S-500 Element.
Type 500 Caustic Soda, per can.
Type 500 Oil, per bottle.

Type S-504 Cell

Capacity 500 ampere hours.
Barrel Shaped heat resisting glass jar.
Size overall, $7 \times 11\frac{5}{8}$ inches.
Jar only, inside dimensions $6 \times 9\frac{1}{2}$ inches.

Description

Type S-504 Cell.
Type S-500 Renewal.

Separate Parts

Type 504 Jar
Type 504 Cover.
Wing nuts and washers, per set.
Type S-500 Element.
Type 500 Caustic Soda, per can.
Type 500 Oil, per bottle.

RAILWAY TRAIN DISPATCHING TELEPHONE SYSTEMS

Batteries and Supplies (Continued)

Exide-Chloride Storage Batteries

In Sealed Glass

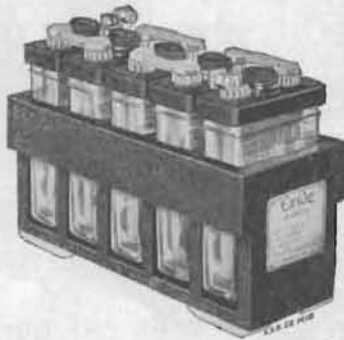

5 Cell BTMH2 Unit

RATED CAPACITIES

Type Cell	In Ampere Hours		
	At 72-Hour Rate to 1.85 Volts	At 8-Hour Rate to 1.75 Volts	At 3-Hour Rate to 1.75 Volts
	BTMH-2	8.4	6
CTMH-2	16.8	12	8.7
PTMH-2	33.6	24	16.8
ETMH-2	50.4	36	24.0

This type of Exide-Chloride is especially suitable for service where a small capacity is required. The positive plate is the well known Manchester type and the negative plate is the familiar Box Negative type. Units are assembled, sealed and charged and filled with electrolyte and include the necessary bolt connectors on the terminal cells of each unit. The PTMH-2 and ETMH-2 units are equipped with chest handles on the crates.

TABLE OF DIMENSIONS AND WEIGHTS

Number of Cells in Crates	BTMH-2 UNITS					CTMH-2 UNITS				
	Overall Dimensions in Inches			Approximate Weight in Pounds		Overall Dimensions in Inches			Approximate Weight in Pounds	
				Complete Unit A.S. & C. Unpacked	Packed for L.C.L. Shipment				Complete Unit A.S. & C. Unpacked	Packed for L.C.L. Shipment
	Length	Width	Height	Complete Unit A.S. & C. Unpacked	Packed for L.C.L. Shipment	Length	Width	Height	Complete Unit A.S. & C. Unpacked	Packed for L.C.L. Shipment
2 Cells—1 Row	5 $\frac{1}{2}$	4 $\frac{13}{16}$	9 $\frac{7}{8}$			11.0	15	6 $\frac{1}{8}$		
3 Cells—1 Row	7 $\frac{7}{8}$	4 $\frac{15}{16}$	9 $\frac{7}{8}$	16.0	23	8 $\frac{1}{16}$	7 $\frac{3}{8}$	11 $\frac{7}{8}$	36.0	45
4 Cells—1 Row	10 $\frac{1}{8}$	4 $\frac{15}{16}$	9 $\frac{7}{8}$	21.0	30	11 $\frac{3}{16}$	7 $\frac{1}{2}$	11 $\frac{7}{8}$	47.0	59
5 Cells—1 Row	12 $\frac{1}{8}$	4 $\frac{15}{16}$	9 $\frac{7}{8}$	26.0	37	13 $\frac{7}{8}$	7 $\frac{3}{8}$	11 $\frac{7}{8}$	58.0	73
6 Cells—1 Row	14 $\frac{1}{8}$	4 $\frac{15}{16}$	9 $\frac{7}{8}$	31.0	44	16 $\frac{1}{2}$	7 $\frac{1}{2}$	11 $\frac{7}{8}$	69.0	87
7 Cells—1 Row	17 $\frac{1}{8}$	4 $\frac{15}{16}$	9 $\frac{7}{8}$	36.0	53	19 $\frac{1}{16}$	7 $\frac{1}{2}$	11 $\frac{7}{8}$	80.0	102
8 Cells—1 Row	19 $\frac{1}{8}$	4 $\frac{15}{16}$	9 $\frac{7}{8}$	42.0	61	21 $\frac{1}{16}$	7 $\frac{1}{2}$	11 $\frac{7}{8}$	91.0	115
9 Cells—1 Row	21 $\frac{1}{8}$	4 $\frac{15}{16}$	9 $\frac{7}{8}$	46.0	67	24 $\frac{1}{4}$	7 $\frac{1}{2}$	11 $\frac{7}{8}$	102.0	129
10 Cells—1 Row	24 $\frac{1}{4}$	4 $\frac{15}{16}$	9 $\frac{7}{8}$	51.0	74	26 $\frac{3}{8}$	7 $\frac{1}{2}$	11 $\frac{7}{8}$	113.0	143
11 Cells—1 Row	26 $\frac{3}{8}$	4 $\frac{15}{16}$	9 $\frac{7}{8}$	56.0	81	29 $\frac{1}{16}$	7 $\frac{1}{2}$	11 $\frac{7}{8}$	124.0	156
12 Cells—1 Row	28 $\frac{1}{8}$	4 $\frac{15}{16}$	9 $\frac{7}{8}$	61.0	88	32 $\frac{1}{16}$	7 $\frac{1}{2}$	11 $\frac{7}{8}$	135.0	170
6 Cells—2 Rows	7 $\frac{7}{8}$	9 $\frac{3}{8}$	9 $\frac{7}{8}$	32.0	45	14 $\frac{9}{16}$	8 $\frac{1}{16}$	11 $\frac{7}{8}$	70.0	77
8 Cells—2 Rows	10 $\frac{1}{8}$	9 $\frac{3}{8}$	9 $\frac{7}{8}$	42.0	61	11 $\frac{3}{16}$	14 $\frac{1}{8}$	11 $\frac{7}{8}$	92.0	116
9 Cells—2 Rows	12 $\frac{1}{8}$	9 $\frac{3}{8}$	9 $\frac{7}{8}$	46.0	70	13 $\frac{7}{8}$	14 $\frac{1}{8}$	11 $\frac{7}{8}$	103.0	133
10 Cells—2 Rows	12 $\frac{3}{8}$	9 $\frac{3}{8}$	9 $\frac{7}{8}$	52.0	75	13 $\frac{1}{8}$	14 $\frac{1}{8}$	11 $\frac{7}{8}$	114.0	144
11 Cells—2 Rows	14 $\frac{1}{8}$	9 $\frac{3}{8}$	9 $\frac{7}{8}$	56.0	83	16 $\frac{1}{8}$	14 $\frac{1}{8}$	11 $\frac{7}{8}$	125.0	160
12 Cells—2 Rows	14 $\frac{3}{8}$	9 $\frac{3}{8}$	9 $\frac{7}{8}$	61.0	88	16 $\frac{3}{8}$	14 $\frac{1}{8}$	11 $\frac{7}{8}$	135.0	171
Single Cell—No Crate	2 $\frac{3}{16}$	4 $\frac{9}{16}$	8 $\frac{7}{16}$	4.5	6	2 $\frac{1}{16}$	6 $\frac{3}{8}$	10 $\frac{1}{8}$	10.4	13

Electrolyte per BTMH-2 Cell—1 pound.

Electrolyte per CTMH-2 Cell—3 $\frac{1}{4}$ pounds.

RAILWAY TRAIN DISPATCHING TELEPHONE SYSTEMS

Exide-Chloride Storage Batteries (Continued)

TABLE OF DIMENSIONS AND WEIGHTS

Number of Cells in Crates	PTMH-2 UNITS					ETMH-2 UNITS				
	Overall Dimensions in Inches			Approximate Weight in Pounds		Overall Dimensions in Inches			Approximate Weight in Pounds	
				Complete Unit A.S. & C. Unpacked	Packed for L.C.L. Shipment				Complete Unit A.S. & C. Unpacked	Packed for L.C.L. Shipment
	Length	Width	Height	Complete Unit A.S. & C. Unpacked	Packed for L.C.L. Shipment	Length	Width	Height	Complete Unit A.S. & C. Unpacked	Packed for L.C.L. Shipment
2 Cells—1 Row	6 ¹³ / ₁₆	8	16 ³ / ₈			42	52	7 ⁷ / ₁₆		
3 Cells—1 Row	9 ⁷ / ₈	8	16 ³ / ₈	60	73	10 ¹³ / ₁₆	10 ⁹ / ₁₆	16 ³ / ₈	91	105
4 Cells—1 Row	12 ¹³ / ₁₆	8	16 ³ / ₈	78	95	14 ¹ / ₁₆	10 ⁹ / ₁₆	16 ³ / ₈	118	137
5 Cells—1 Row	15 ³ / ₄	8	16 ³ / ₈	97	117	17 ⁷ / ₁₆	10 ⁹ / ₁₆	16 ³ / ₈	146	168
6 Cells—1 Row	18 ¹¹ / ₁₆	8	16 ³ / ₈	115	140	20 ⁹ / ₁₆	10 ⁹ / ₁₆	16 ³ / ₈	173	201
7 Cells—1 Row	21 ⁵ / ₈	8	16 ³ / ₈	133	162	23 ¹³ / ₁₆	10 ⁹ / ₁₆	16 ³ / ₈	201	233
8 Cells—1 Row	24 ³ / ₈	8	16 ³ / ₈	152	184	27 ¹ / ₁₆	10 ⁹ / ₁₆	16 ³ / ₈	230	266
9 Cells—1 Row	27 ¹ / ₂	8	16 ³ / ₈	170	207	30 ⁵ / ₁₆	10 ⁹ / ₁₆	16 ³ / ₈	258	297
10 Cells—1 Row	30 ⁷ / ₁₆	8	16 ³ / ₈	188	228	33 ⁹ / ₁₆	10 ⁹ / ₁₆	16 ³ / ₈	286	329
11 Cells—1 Row	33 ⁵ / ₈	8	16 ³ / ₈	206	249
12 Cells—1 Row	36 ³ / ₄	8	16 ³ / ₈	225	271
6 Cells—2 Rows	9 ⁷ / ₈	15 ³ / ₈	16 ³ / ₈	118	143	10 ¹³ / ₁₆	20 ¹ / ₂	16 ³ / ₈	178	206
8 Cells—2 Rows	12 ¹³ / ₁₆	15 ³ / ₈	16 ³ / ₈	155	188	14 ¹ / ₁₆	20 ¹ / ₂	16 ³ / ₈	235	270
9 Cells—2 Rows	15 ³ / ₄	15 ³ / ₈	16 ³ / ₈	174	215	17 ⁷ / ₁₆	20 ¹ / ₂	16 ³ / ₈	263	306
10 Cells—2 Rows	18 ¹¹ / ₁₆	15 ³ / ₈	16 ³ / ₈	192	232	17 ¹³ / ₁₆	20 ¹ / ₂	16 ³ / ₈	290	333
11 Cells—2 Rows	21 ⁵ / ₈	15 ³ / ₈	16 ³ / ₈	211	258	20 ⁹ / ₁₆	20 ¹ / ₂	16 ³ / ₈	318	368
12 Cells—2 Rows	24 ³ / ₈	15 ³ / ₈	16 ³ / ₈	229	275	20 ⁵ / ₁₆	20 ¹ / ₂	16 ³ / ₈	345	395
Single Cell—No Crate	2 ⁷ / ₈	6 ¹³ / ₁₆	14 ¹³ / ₁₆	17	21	2 ¹³ / ₁₆	9 ⁷ / ₈	14 ¹³ / ₁₆	26	31

Electrolyte per PTMH-2 Cells, 4³/₄ pounds.

Electrolyte per ETMH-2 Cell—7³/₄ pounds.

INDEX

Material	Page	Material	Page
Adapters, Condenser	37	Key Spaces, Selector	94
Amplifiers	19, 20	Layout of System	3-6
Apparatus Cases, Selector	7, 88	Lead Covered Cable	31
Arms, Transmitter	105, 106	Line Material	Information on Request
Attachments, Foot Switch	96	Line Poles	69
Attachments, Transmitter	110	Loud Ringing Extension Bells	28
Batteries and Supplies	111-115	Loud Speaking Telephone Equipment	18, 20, 103
Battery Boxes	28	Micas, Protector	74
Battery Requirements	21-23	Mountings, Gong	51
Bells	17, 28	Mountings, Jack	66
Binding Posts	30	Panels, Switching and Testing	108
Booth Switches	96	Plugs	70, 71
Boxes, Battery	28	Poles, Line	69
Boxes, Desk Set (Subscriber Sets)	15, 17, 47, 48	Portable Telephone Sets	100, 101
Boxes, Hand Generator	50	Posts, Binding	30
Boxes, Jack	15, 62-65	Protectors	18, 72
Brackets, Condenser	37	Protector Blocks	73, 74
Brackets, Transmitter	106	Protector Micas	74
Cables	31	Push Button Switches	97
Cable Terminals	31-33	Punchings, Terminal	30
Cases, Selector Apparatus	7, 88	Receivers	76-78
Cases, Selector Key	94	Rectifier, Vacuum Tube	21-23, 74
Circuit Breakers	7, 33	Relays	7, 75
Code Settings for Selectors	10	Repeating Coils	23-26, 79
Coils, Induction	52, 53	Resistances	20, 81
Coils, Repeating	23, 26, 79	Retardation Coils	7, 80
Coils, Resistance	20, 81	Ringers	16, 82-85
Coils, Retardation	7, 80	Selectors	16, 86, 87
Combined Jacks and Signals	65, 66	Selector Apparatus Cases	7, 88
Condensers	34-36	Selector Keys	8-13, 89-93
Condensers, Adapters, Brackets, Straps	37	Selector Key Cases	94
Connecting Blocks	28	Selector Key Spaces	94
Cords	39-41	Selector Sets	15, 94, 95
Cord Tips	42-44	Sets, Telephone	27, 98-102
Designation Strips	44	Sets, Test	27, 107, 108
Desk Set Boxes (Subscriber Sets)	15, 17, 47, 48	Set, Time Sending	14, 104
Desk Stands	45, 46	Signals, Combined with Jacks	65, 66
Dispatcher's Station Circuit	58	Stands, Desk	45, 46
Dry Batteries	111	Straps, Condenser	37
Extension Bells	28	Strips, Designation	44
Emergency Cable	31	Subscriber Sets	(See Desk Set Boxes)
Foot Switches	20, 96	Switches, Booth	96
Foot Switch Attachments	96	Switches, Foot	20, 96
Fuses	48, 49	Switches, Push Button	97
Generators	50	Switch Hooks	96, 97
Generator Boxes	50	Telephone, Loud Speaking	18, 20, 103
Gongs, Gong Mountings	51	Telephone Sets	27, 98-102
Hand Generator, Boxes	50	" (Portable)	100, 101
Hand Sets	52	Telephones, Weatherproof	102
Head Bands, Receiver	78	Terminals, Cable	31-32
Head Sets	52	Terminal Punchings	30
Hook Switches	96, 97	Test Sets	27, 107, 108
Howlers	52	Time Sending Set	14, 104
Indicator Fuses	48, 49	Tips, Cord	42-44
Induction Coils	52, 53	Tools	106
Interior Cable	31	Transformers	23-26, 104
Interrupters	52, 53	Transmitters	109, 110
Jacks	54-57, 60-62	Transmitter Arms	105, 106
Jack Boxes	15, 62-65	Transmitter Arm Brackets	106
Jacks for Pole Mounting	62	Transmitter Attachments	110
Jack Mountings	66	Transmitter Brackets	106
Jacks, Combined Jacks and Signals	65, 66	Tubular Fuses	49
Keys	67-68	Vacuum Tube Rectifier	21-23, 74
Key Cases, Selector	94	Way Station Circuit	59
Key Levers	68	Way Station Equipment	15-18
Keys, Selector	8-13, 89-93	Weatherproof Telephones	102

DISTRIBUTOR IN THE UNITED STATES

Graybar

ELECTRIC COMPANY

Akron
Albany
Asheville
Atlanta
Baltimore
Beaumont
Birmingham
Boston
Brooklyn
Buffalo
Charlotte
Chicago
Cincinnati
Cleveland
Columbus

Dallas
Davenport
Dayton
Denver
Detroit
Duluth
Durham
Flint
Fort Worth
Grand Rapids
Hammond
Harrisburg
Hartford
Houston
Indianapolis

Jacksonville
Kansas City
Knoxville
Los Angeles
Louisville
Memphis
Miami
Milwaukee
Minneapolis
Mount Vernon
Nashville
Newark
New Haven
New Orleans
New York (2)

Norfolk
Oakland
Oklahoma City
Omaha
Philadelphia
Pittsburgh
Portland
Providence
Reading
Richmond
Roanoke
Rochester
St. Louis
St. Paul

Salt Lake City
San Antonio
San Francisco
Savannah
Seattle
Spokane
Syracuse
Tacoma
Tampa
Toledo
Washington
Wichita
Worcester
Youngstown

A NATIONAL ELECTRIC SERVICE

DISTRIBUTOR FOR CANADA AND NEWFOUNDLAND

Northern  *Electric*
COMPANY LIMITED

General Sales Offices: 1261 Shearer Street, Montreal, P. Q.

A NATIONAL ELECTRICAL SERVICE

ST. JOHN N. B. HALIFAX QUEBEC MONTREAL OTTAWA TORONTO HAMILTON LONDON WINDSOR NEW LISKEARD SUBURRY WINNIPEG REGINA CALGARY EDMONTON VANCOUVER

FOREIGN DISTRIBUTORS

International Standard Electric Corporation

67 Broad Street

New York, U. S. A.

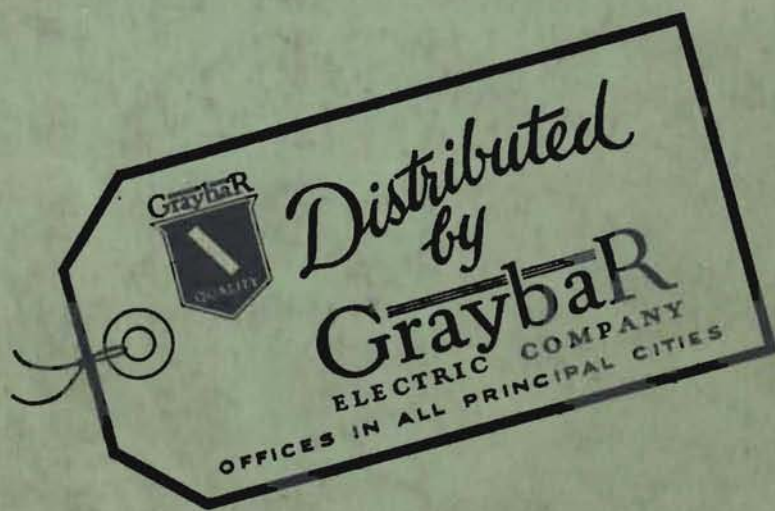

*Distributed
by*

GraybaR

ELECTRIC COMPANY

OFFICES IN ALL PRINCIPAL CITIES