

# TELEPHONE COMMUNICATION SYSTEMS

---

VOLUME I  
EARLY SYSTEMS AND STATION EQUIPMENT



GRADUATE ENGINEERING  
AND  
INFORMATION SYSTEMS EDUCATION

## TELEPHONE COMMUNICATION SYSTEMS

This material is prepared for training purposes only and is the property of Western Electric Company, Incorporated, and is loaned on condition that it be returned to the Company upon termination of employment or upon request by the Company prior thereto. No reproduction of this material, in whole or in part, and no disclosure of any part of this material to other than fellow employees, as may be necessary in connection with work assignments, may be made without prior permission in writing from the Company.

## PREFACE

Connecting any two phones among the millions of subscribers is accomplished by telephone switching systems. The process, although not simple, is normally taken for granted in our everyday use of telephone services. This is indeed a compliment to the Bell System people who have developed, engineered, and maintained the many types of telephone systems. The switching equipment in the Central office is considered by many to be the heart of the telephone highway, for without it the telephone never would have progressed to the highly developed and integrated entity it is today.

Although the switching equipments may be considered the "heart," the other parts of the telephone network are equally important. For without the connecting wires and cables, the subscribers' equipment and the power plant, there could be no universal telephone network and no Direct Distance Dialing.

Switching is a highly dynamic field. From the first crude switching arrangements developed by the Holmes Electric Company in Boston in 1877 to the highly sophisticated No. 1 ESS system developed by the Bell System Laboratories in the early 1960's, the telephone switching system has indeed come a long way. What the future holds can only be speculated upon: on the horizon, we now see new developments, such as the use of satellites, lasers, and holography in communications.

Each subject covered in this text could be developed much more extensively; however, our objective is not to print a comprehensive treatise on telephony, but rather to treat each subject briefly presenting a general technical explanation of its operation and function.

This text has been prepared for Graduate Engineering Education courses presented at the Western Electric Corporate Education Center. Its contents are the result of over 12 years of development, starting from a group of handouts given to students and leading to the book we have today. Although much of the material and ideas were taken from various Bell System sources, a great deal of the book can be attributed to the members of the Graduate Engineering Education staff. Acting as writers, instructors, and editors, each diligently worked in assembling a well organized telephone communications text. Their collective efforts are sincerely appreciated, and are hereby gratefully acknowledged.

J. E. GARRETT  
Manager, Graduate Engineering  
and Information Systems Education

Corporate Education Center  
Hopewell, New Jersey

## CHAPTER 5

### PANEL SWITCHING SYSTEM

#### 5.1 INTRODUCTION

The panel system is a local dial switching system that was developed so that dial operation might be applied in large metropolitan areas where the number of central offices to be served created complicated trunking problems. In the panel system, direct control of the switches by the subscribers' dial is abandoned in favor of a register or sender in which the dialed pulses are stored until the equipment is ready to use them. This allows the selecting apparatus more time to hunt over large trunk groups than is normally permitted between the digits dialed by a subscriber. The system is applied only in the larger areas because it does not compete economically with the step-by-step system in exchange areas with a small number of central offices or in communities with only a small number of subscribers lines.

#### 5.2 APPARATUS ELEMENTS

##### A. PANEL SELECTORS

In order to understand fully the operation of the panel type dial system it is necessary to study the mechanical details of the various pieces of apparatus. The principal piece of apparatus which gives the system its name is the panel type selector, so called, because the terminals over which the selector passes, are arranged in a flat rectangular bank or panel. This is used throughout the system in various forms, differing in size, in detailed arrangements and in electrical connections, but all having the same general mechanical construction. We will begin by considering the general construction and describe later the detailed differences which distinguish the various selectors.

Figure 5-1 is a general view of a selector frame. It will be observed that all apparatus is mounted upon a structural iron framework securely bolted to the floor and to the ceiling. In Figure 5-1 there will be seen several banks of terminals mounted one above the other.

Figure 5-2 shows one of these banks removed from the frame. It consists of flat strips of brass having projecting lugs, separated by strips of insulating material and clamped together by long bolts passing through holes in all of the strips. The lugs are so arranged that they project on both sides of the bank and are repeated thirty times on the front and thirty times on the rear of each strip. A set of three strips constitutes the terminals of one line or trunk and they are designated "tip," "ring" and "sleeve" terminals as in manual practice.

The terminals of the lines or trunks then appear in vertical rows, each row containing 100 lines or trunks in each bank and there are thirty such rows on the front and thirty on the rear, so that, each line or trunk appears sixty times in each bank. Connections to the lines or trunks are made by wire soldered to lugs at one or both ends of the bank. In actual practice, in those selector frames where these terminals represent trunks, only 90 of the 100 possible trunks in each bank are used as trunks, the remaining 10 being required for other purposes.

The selectors consist of hollow brass rods, one mounted opposite each vertical row of three terminals and arranged to slide up and down. Since there are 60 vertical rows, 60 selectors can be accommodated on each frame, 30 on each side. The selector tubes carry sets of spring fingers or "brushes" in front of each bank which may be made to rub on the terminals when the selector is driven up or down. Connections from the brushes are carried through the rods to sliding contacts at the top.

In the middle of the frame at the bottom are long rolls covered with cork composition which are constantly revolved by an electric motor through the medium of gears. The lower roll rotates in such a direction as to drive the selector upward and the upper roll in the opposite direction to drive the selector downward. Each selector tube is attached at its lower end to a flat strip of bronze called a "rack," which normally stands just in front of the revolving rolls but not touching them. In front of each rack is an electro-mechanical device called a "clutch." A separate clutch, selector rod and drive unit are shown in Figure 5-3. When an electric current is passed through one of the magnets of the clutch, a roller attached to its armature presses the rack against one of the revolving cork covered rolls which, by friction, moves the selector up or

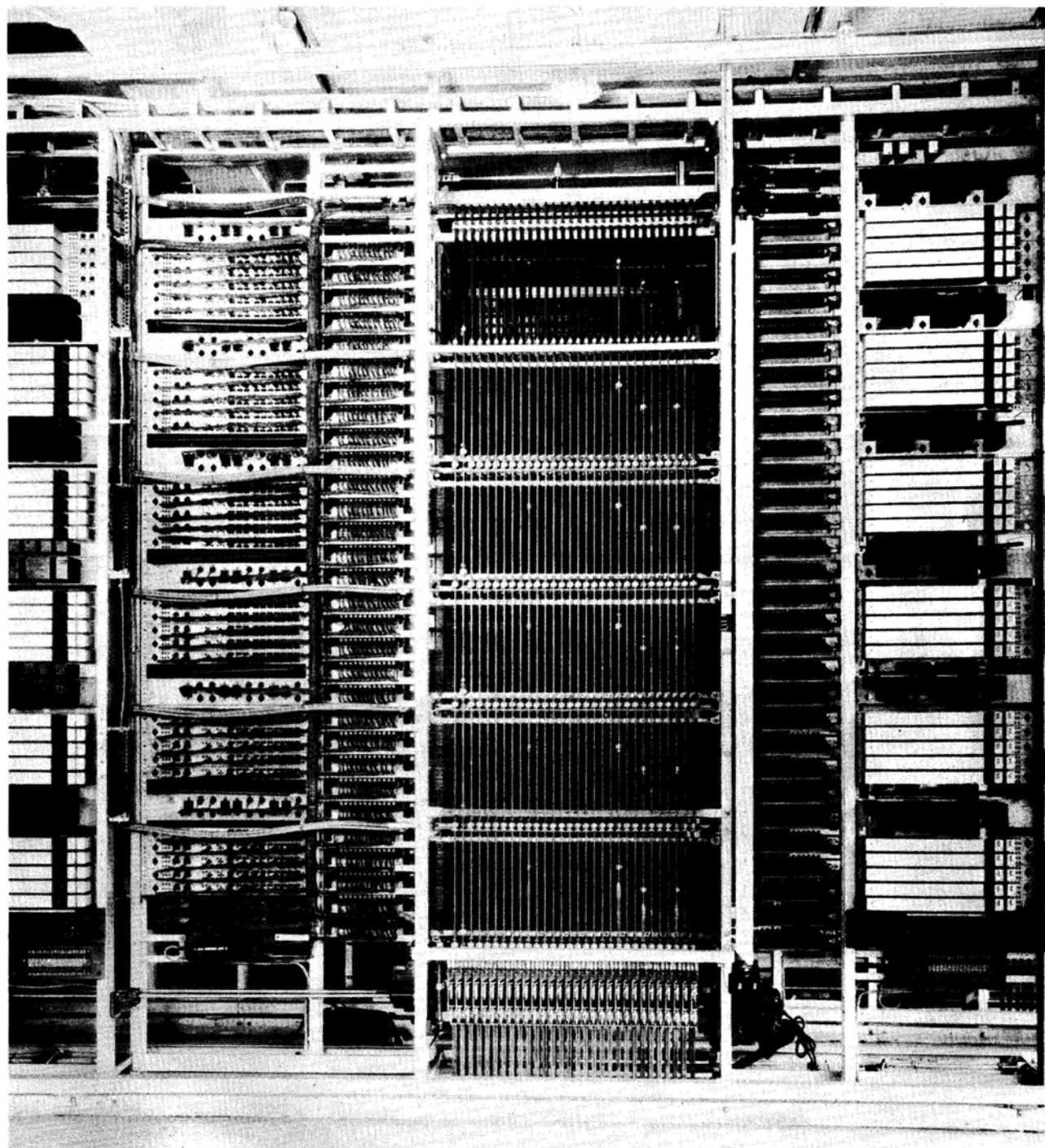

Figure 5-1 Typical Panel Dial Selector Frame

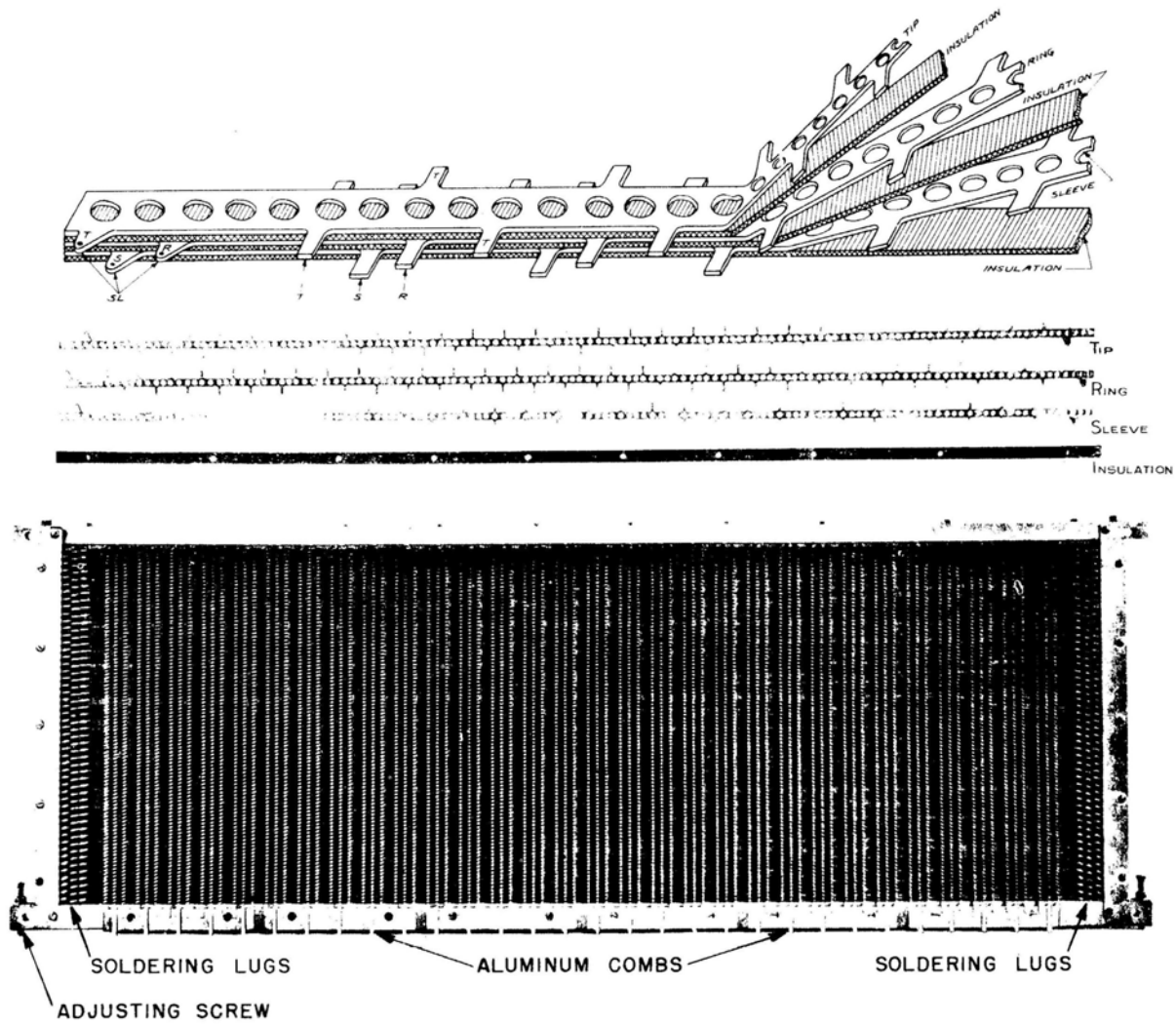

Figure 5-2 Panel Multiple Bank

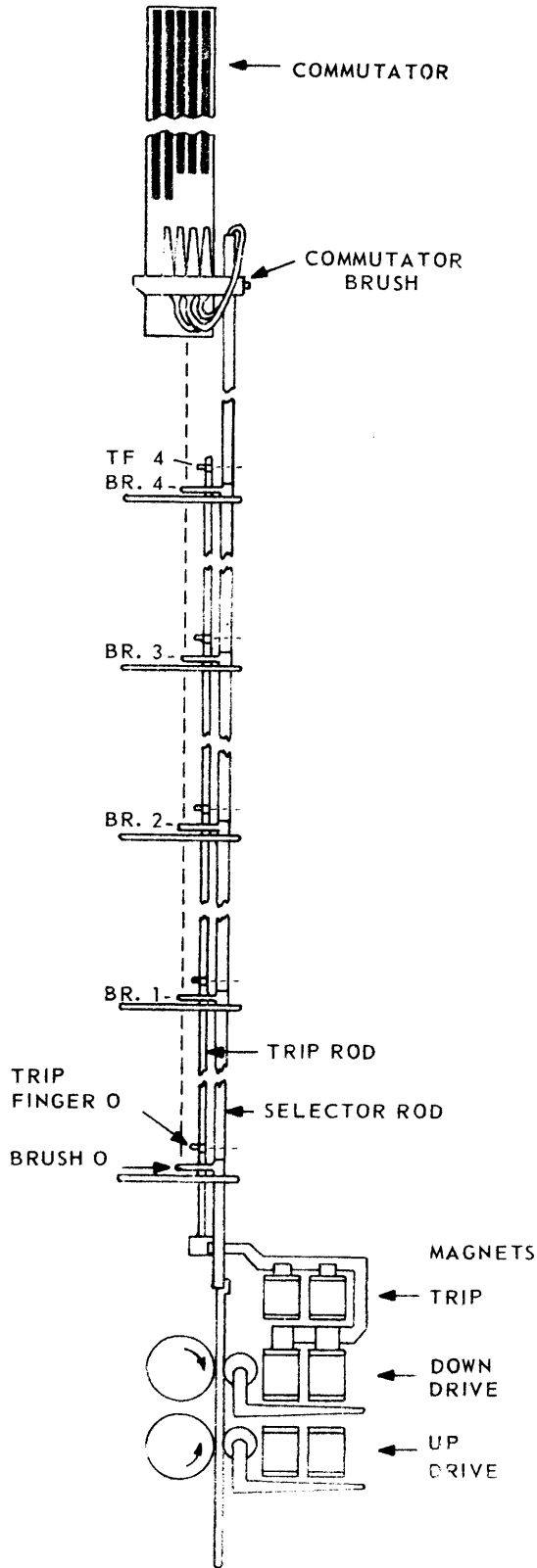

Figure 5-3 Selector Rod, Drive Mechanism, and Clutch Assembly



down. A spring pawl just above the upper roller of the clutch drops into notches punched in the rack, which can be seen in Figure 5-4, and prevents the selector from falling when it has been raised. An arm on the armature of the down drive magnet of the clutch withdraws the pawl when the selector is driven downward. The rack, brushes, and upper part of the clutch are clearly shown in Figure 5-4.

Corresponding terminals of the five brushes on each selector tube are connected together by wires which pass inside the tube and come out at the top where they are connected to another brush of different construction mounted at the extreme top of the tube. This brush slides on a "commutator" which consists of brass bars molded in insulating material and serving to conduct current which enters the commutator through the moving selector brushes. The commutator and the commutator brush also control electrically the movement of the selector, as will be described later. The commutator and commutator brush are shown in Figure 5-5.

The selector brushes which are shown in detail in Figure 5-6 do not normally touch the terminals, their fingers being held apart by two little hard rubber rollers which are forced between them. When the selector rises, no contact is made with any of the terminals unless one of the brushes is closed or "tripped" by withdrawing the rubber rollers which hold the brush open. One method of tripping a desired brush is described in the following. Between each selector tube and its terminals and encircled by the fingers of the brushes, is a small vertical brass rod arranged to be partially rotated by a magnet at the top of the clutch (see Figure 5-4). This rod carries five spring-mounted latches and is called the "trip rod." Either in the normal position or when full rotated, the latches of the trip rod do not interfere with the movement of the selector, but if the selector is raised to a certain point and the trip rod then rotated, one of the latches will catch on a projection of the associated brush and be held there while the other latches continue to rotate with the trip rod. This projection is attached to the hard rubber rollers which hold the brush open and any further upward movement of the selector will now cause the hard rubber rollers to be withdrawn and the brush to close and make contact with the terminals of the bank. When the selector descends again, a long trigger

attached to the hard rubber rollers strikes the framework and restores the brush to its normally open position just as it reaches the lowest point of its travel.

The brushes on the selector tube and the latches on the trip rod are placed equal distances apart but the latches are not the same distance apart as the brushes. There is, therefore, a certain position of the selector in which the first latch on the trip rod will, if the rod is turned, catch the projection on the first brush but in this position none of the other latches will catch the projections on the other brushes, being too high. Similarly, there is a certain position in which only the second brush will be caught, the latch for the first brush being too low and the latches for the other brushes being too high. This is shown diagrammatically in Figure 5-7. Thus by moving the selector up to a certain point before turning the trip rod, any one brush on that selector can be tripped at once. By this plan any terminal in any of the five banks can be reached by the selector although the total travel of the selector is only the height of one bank.

On the line finder frame a different method of brush tripping is used. Here any one of the thirty selectors on either side of the frame may rise in response to a start signal from the subscribers line, however, once selection has started, only one elevator can updrive. In this case the trip rods are mounted horizontally at the bottom of each of the 10 banks. The trip fingers are so located that when a trip magnet operates, the fingers swing over the trip levers of all the idle finder brushes in the bank in which the subscribers line appears. Any normal elevator if then made to rise, will have the plunger of that brush pulled out, allowing the brush to make contact with the bank terminals as the line finder rises. The other brushes on the rod, not being tripped, do not touch the bank terminals.

#### B. SEQUENCE SWITCH

The circuits which control the movements of panel type selectors are necessarily complicated and their operation requires the making and breaking of a large number of connections. Some of these connections are established or broken by means of relays. To reduce the

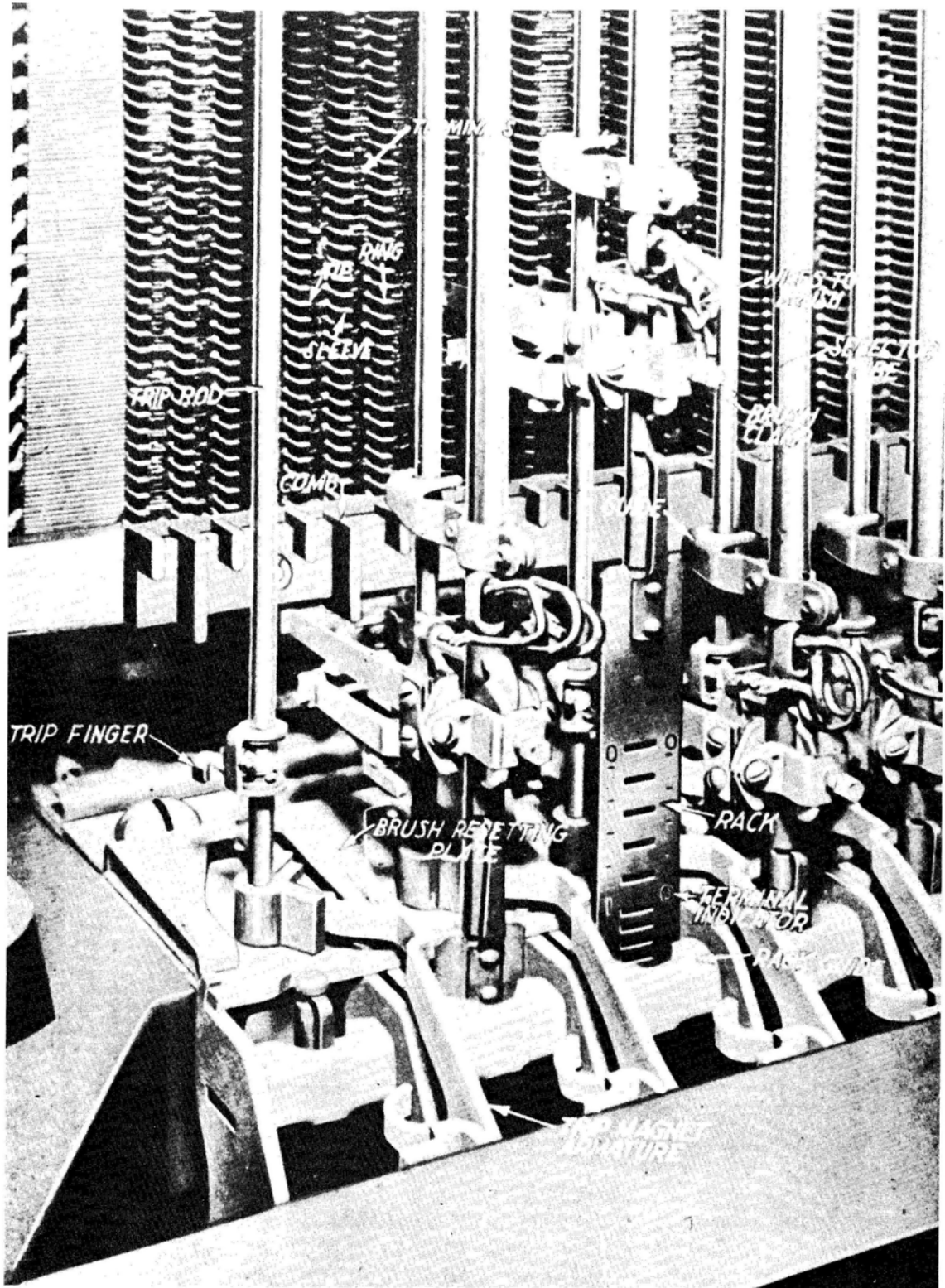

Figure 5-4 Panel Type Selecting Mechanism

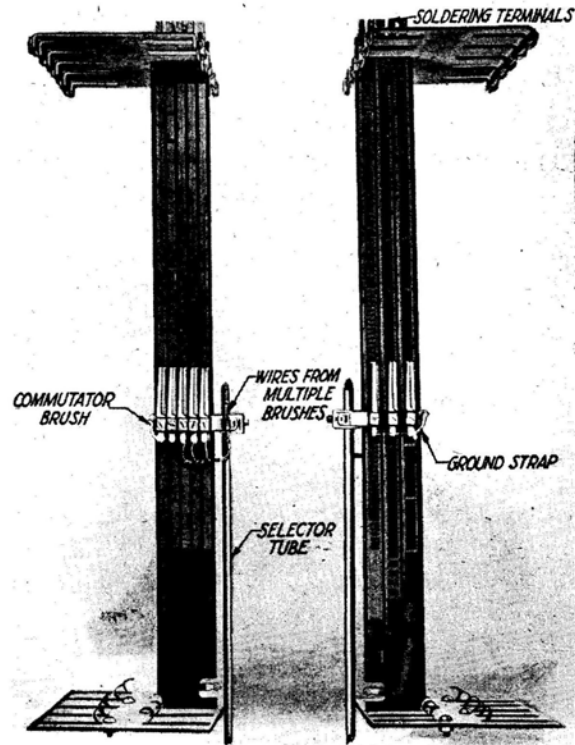

Figure 5-5 Panel Commutator Mechanism

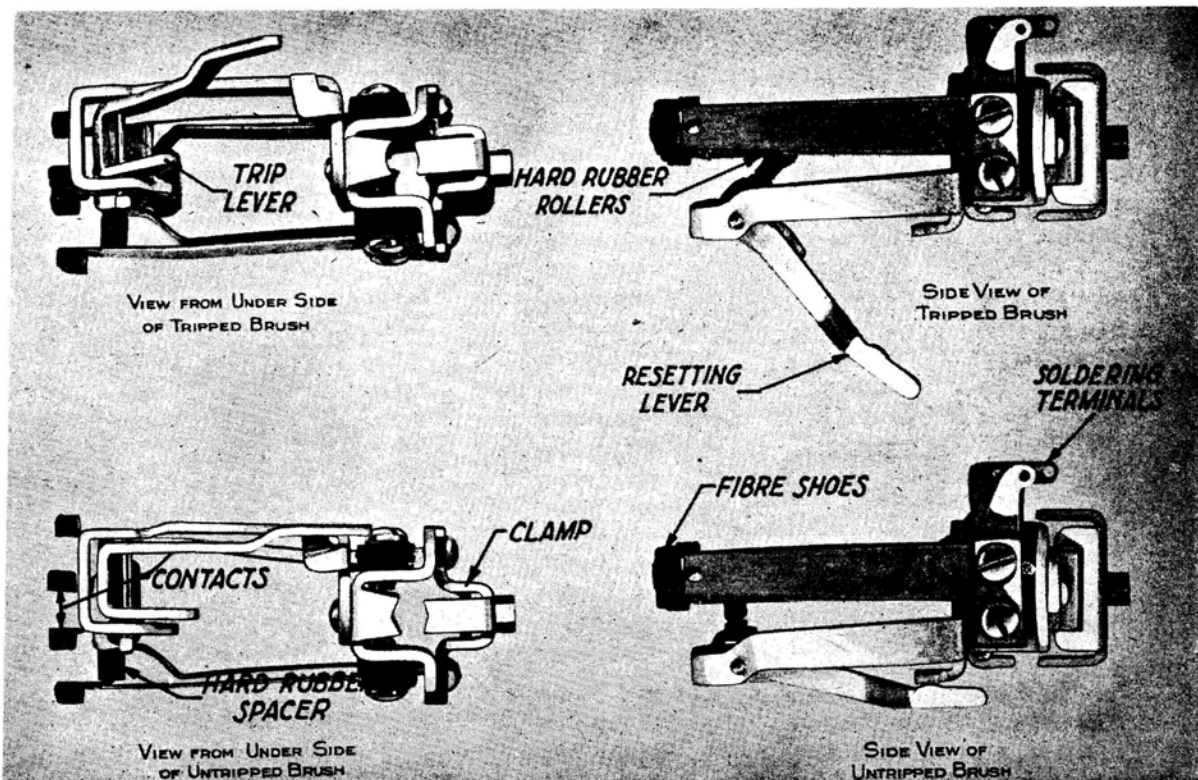

Figure 5-6 Panel Brush Mechanism

number of relays required, a special form of switch called a "sequence switch" has been developed which, in general, performs the functions of a group of relays. Figure 5-8 shows one of these switches, one of which is associated with each selector.

The sequence switch consists of a number of discs or "cams," each composed of two plates of metal riveted one on each side of a disc of insulating material and all mounted on a square shaft which can be revolved. Four contact springs rest on each disc and a fluted cam with a spring roller at the end of the shaft serves to hold the shaft in any one of eighteen positions. These positions are indicated by a numbered wheel at the opposite end of the shaft. The metal plates are cut out with irregular notches so that in certain positions of the shaft certain contact springs rest on the metal of the plates and others on the insulating material; while in other positions, different springs rest on the metal and the insulation, respectively. Turning the shaft therefore, serves to make and break the connections between contact springs in various combinations. As one of these switches will accommodate as many as 24 cams, each of which has four contact springs, there may be 96 separate wires connected to the switch which by turning the shaft can be connected or disconnected in 18 different arrangements. Each arrangement is capable of an almost infinite number of variations by changing the shape and size of the notches in the metal plates. Contacts may be made or broken simultaneously or separated by exact time intervals, which is difficult to do by means of relays.

The functions of a sequence switch in controlling a selector are enumerated in Table 5-1. Position number 1 is the normal position of the switch when the selector is not in use. As soon as the selector has been chosen to be used in making a call, it is necessary to select an idle sender. This is not done by the sequence switch but it serves to make certain electrical connections for this purpose when it is turned to position Number 2. Until the idle sender has been found, nothing more can be done; so the sequence switch is turned to position Number 3, where the connections are arranged to wait for the sender. In the same way, for each new operation to be performed, the sequence switch is turned to a new position and in that position makes the proper electrical connections for that operation.

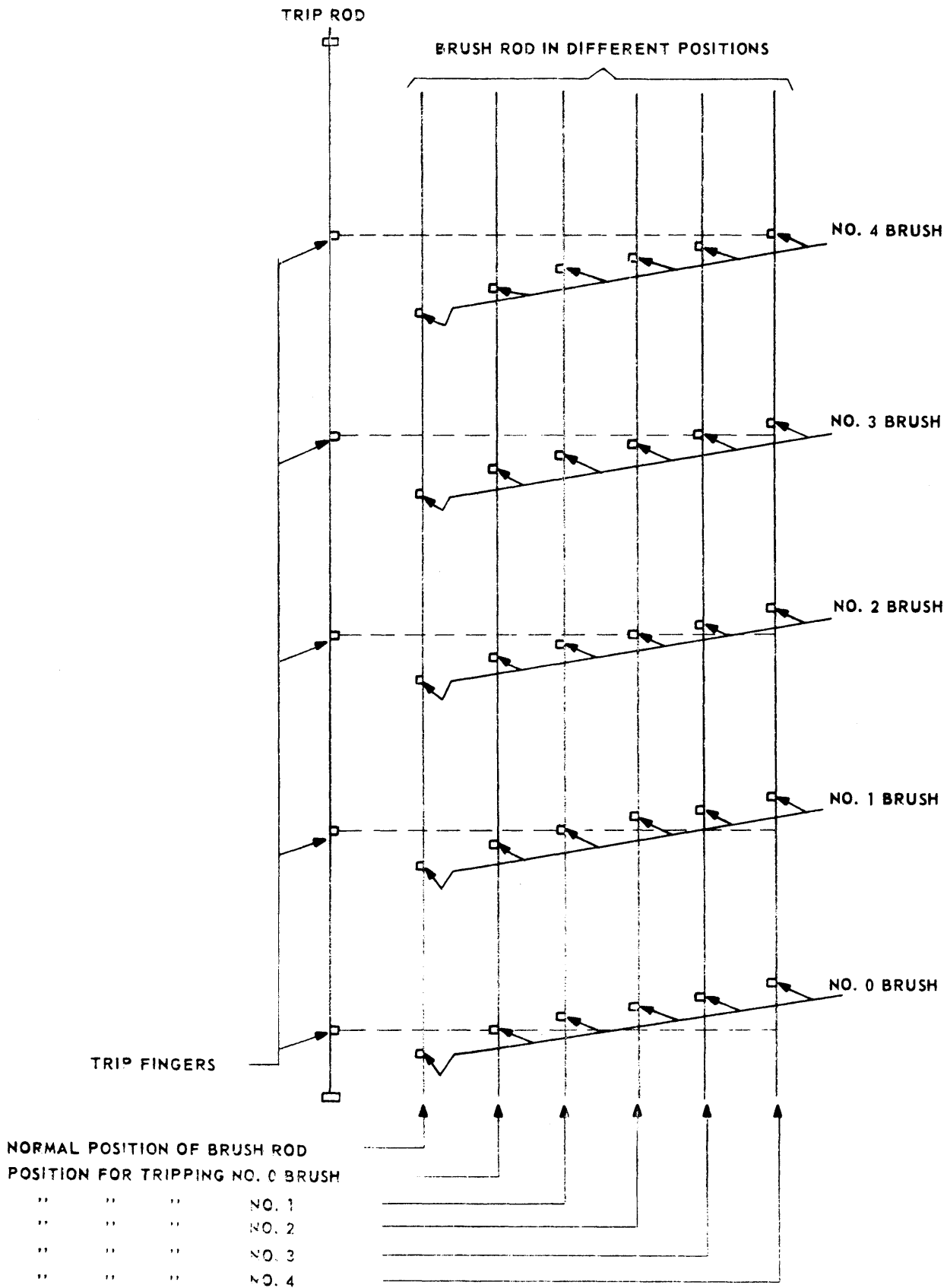

Figure 5-7 Brush Selection

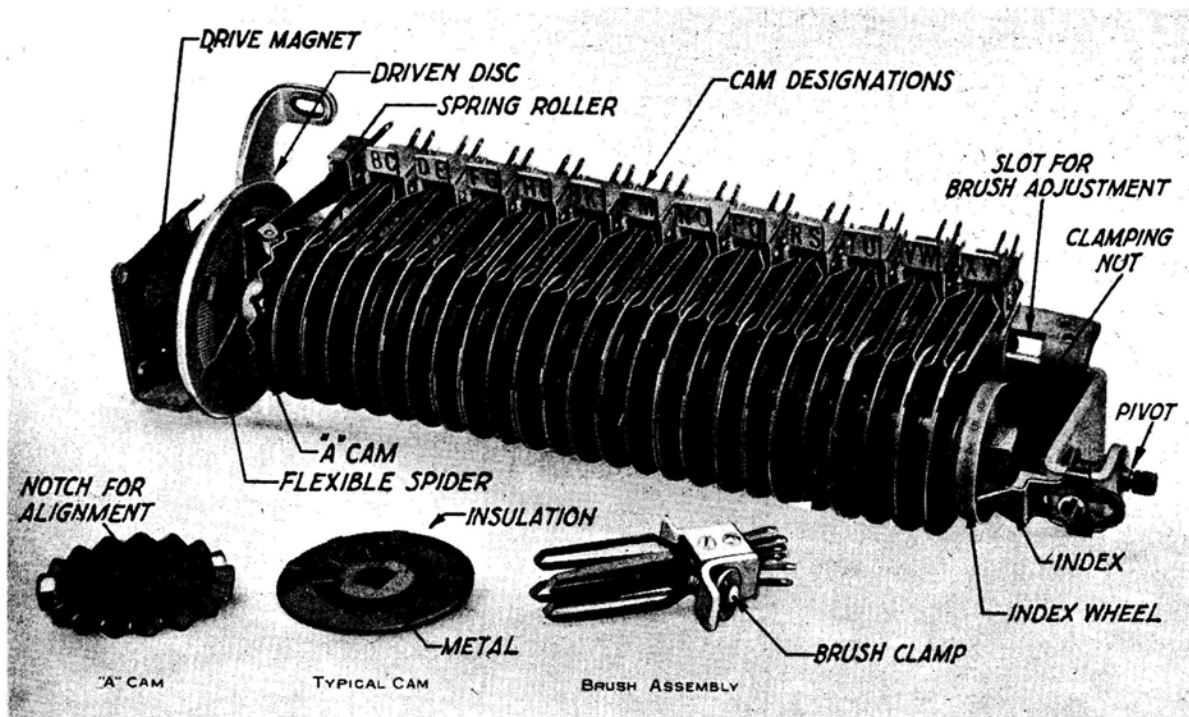

Figure 5-8 Sequence Switch

The sequence switch is turned by a friction drive mechanism at the end of its shaft. Next to the fluted cam is an iron disc mounted on a flexible bronze spider. With the sequence switch mounted on the framework, this disc stands close to but not touching a horizontal iron disc on a vertical brass shaft which is constantly revolved by the same motor which drives the cork covered rollers for the selector drive. Close to the first disc is an electromagnet. When current is applied to this magnet, the flexible mounted disc is drawn against the revolving disc and the sequence switch shaft is driven around by friction. The current on the magnet is maintained by a contact spring on the fluted cam which does not allow the switch to stop until it falls into an insulated notch in the fluted cam. It is only necessary, therefore, to put current on the magnet momentarily and the switch will revolve to the next position at which there is a notch in the fluted cam. If there is no notch in a position, the switch will not stop in that position. Each time the switch stops it is necessary to apply current momentarily to the magnet to make it turn to the next position.



TABLE 5-1  
DISTRICT SEQUENCE SWITCH

Position	Corresponding Circuit Condition
1	Normal.
2	Selecting an idle sender.
3	Waiting for sender.
4	Selecting brush.
5	Waiting for sender.
6	Selecting group.
7	Waiting for relays.
8	Hunting idle trunk.
9	Waiting for sender.
10	Selection of brushes, groups, etc. beyond the district selector.
11	Waiting for sender.
12	Talking (nonloaded trunk).
13	Talking (medium-loaded trunk).
14	Waiting for operator to answer.
15	Talking to operator.
16	All trunks busy.
17	Operating message register.
18	Returning apparatus to normal.

### 5.3 EQUIPMENT ELEMENTS

The switching network, of the Panel System, consists of line finders, district and office frames, and incoming and final multiple banks.

#### A. LINE FINDER FRAME

The line finder frame provides a means of associating subscribers' lines with central office equipment used in establishing connections. The frame consists of ten multiple banks each of which has a capacity of forty lines. This is known as a 400-point frame. An earlier frame made provision for 300 points but is no longer used. Subscribers' lines are terminated on the multiple banks and have access to selectors. Traffic density through the frame is determined by the calling pattern of the subscribers on the frame. It is desirable, then, to provide a flexible pattern of selectors to the



400 lines. This is accomplished by providing an arrangement of splitting the banks and allowing the 400 lines to have access to twenty, twenty-eight, forty, or sixty selectors.

With many lines being served by few selectors there is a need for some preference arrangement on the line finder frame. To accomplish this, the multiple bank is split in the center and a reversal is inserted between the two halves of the bank. The split forms two subgroups, A and B, and half of the selectors serve each subgroup. The reversal in the bank changes the preference of the subscribers' line in each subgroup. He may be last preference in subgroup A, but he would have first preference in subgroup B. Figure 5-9 shows a line finder bank split into subgroups A and B served by sixty selectors. Figure 5-10 shows other possible arrangements of the line finder group.

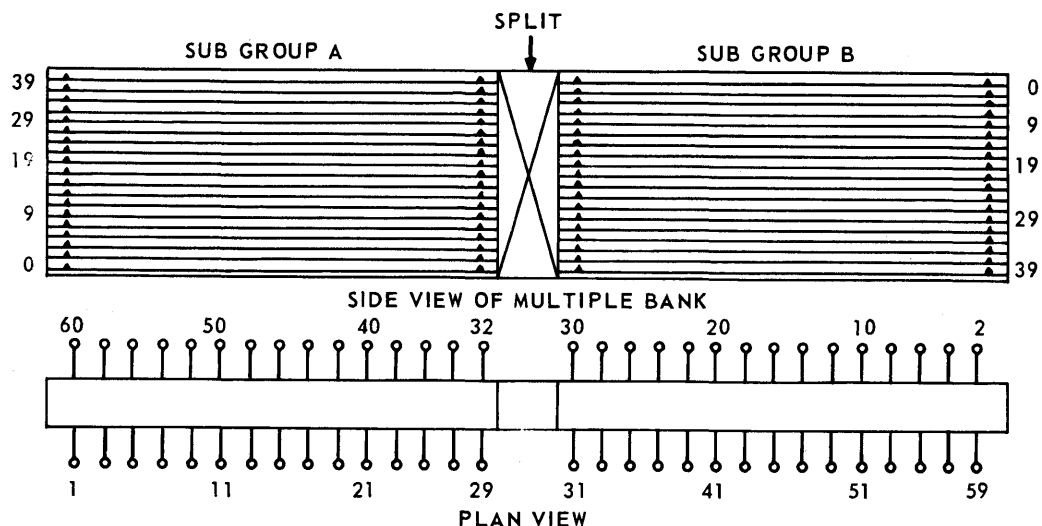

ARRANGEMENT OF MULTIPLE BANK USED FOR TERMINATING 400 LINES PER FRAME  
400 LINES MULTIPLIED BEFORE A MAXIMUM OF 60 LINE FINDERS

Figure 5-9 Line Finder Group

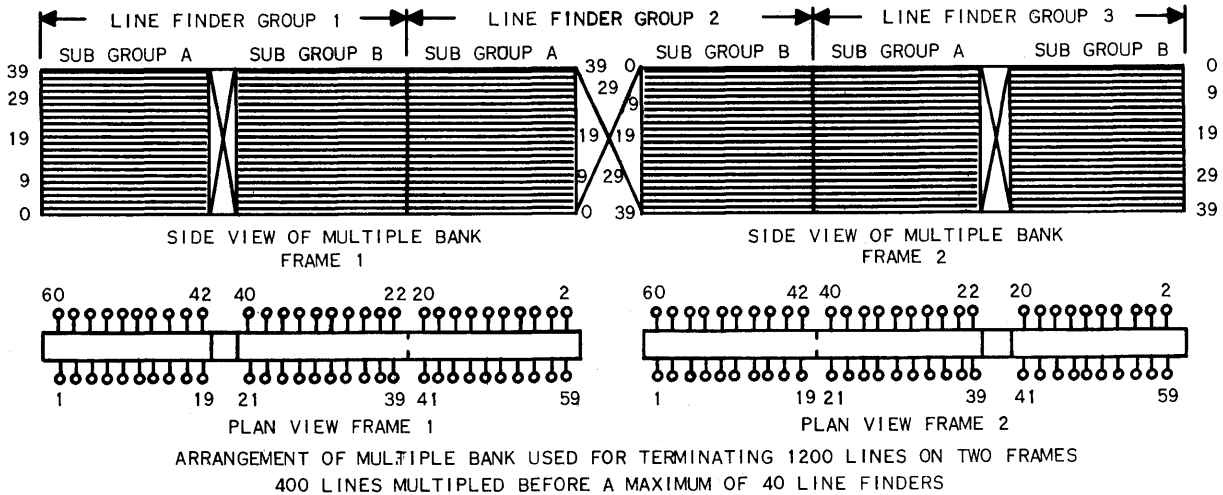
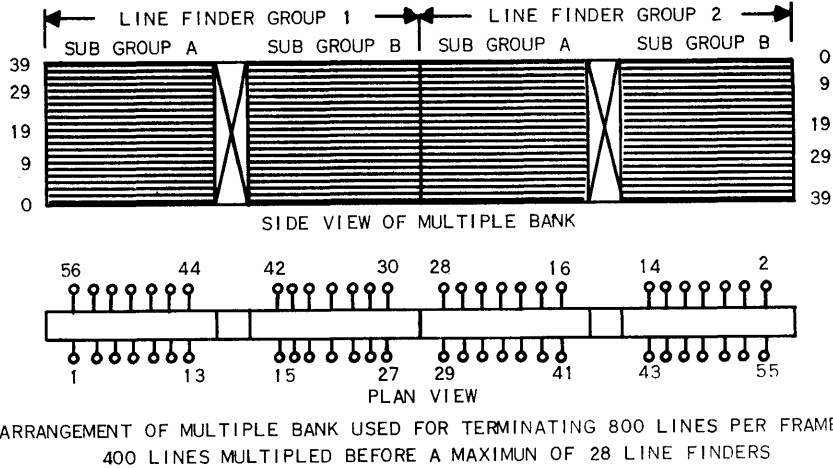

Figure 5-10 Arrangements of Line Finder Multiple Banks

**B. DISTRICT FRAME**

The district frame provides the proper routing for the originating call. At this frame appear trunks to other offices, to operator or desk positions, or to office frames containing trunks to other offices.

The district frame consists of five multiple banks of 100 terminals per bank and has a capacity for 60 selectors together with the associated mechanism. Each bank is made up of ten sets of terminals consisting of eight sets of 11 terminals each and two sets of six terminals each. The last terminal in each set is wired as an overflow terminal, leaving 90 terminals in each bank available for assignment as trunks or paths. In case more than ten trunks are required for a trunk group the overflow terminal is so wired that it will test busy instead of giving an overflow. In this way, it is possible to establish trunk groups of more than 10 trunks and to arrange for a selector to hunt over the entire group for an idle trunk. Figure 5-11 illustrates a district frame trunk assignment in an office without office frames.

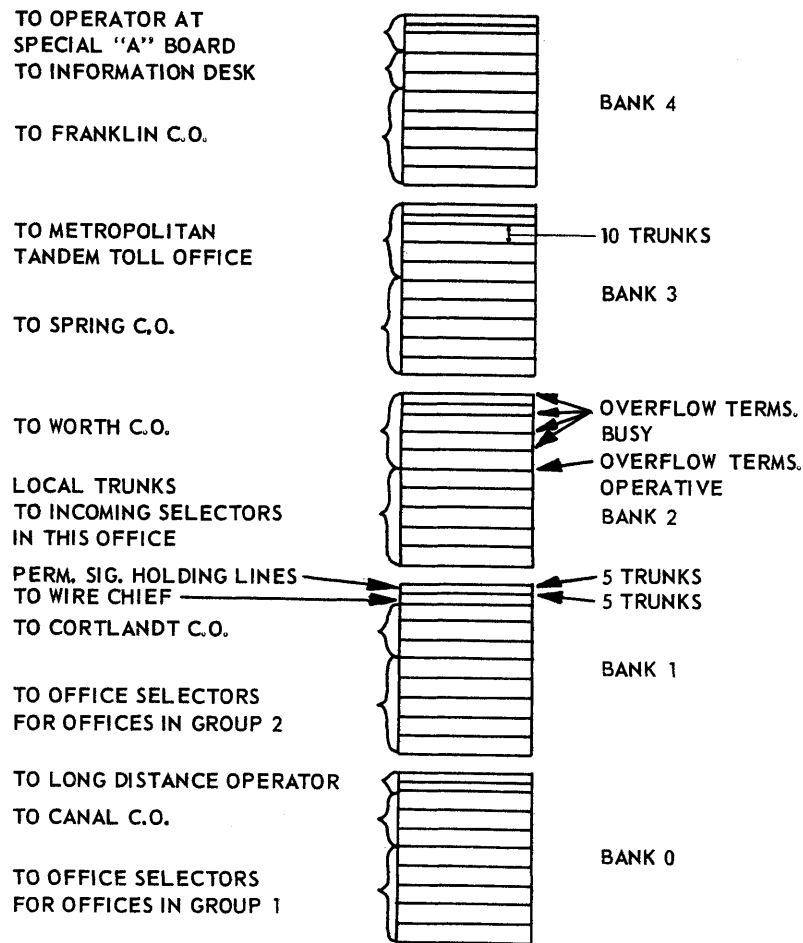

Figure 5-11 Terminal Banks of District Frame

C. OFFICE FRAME

Office frames are installed to provide additional outgoing trunk capacity when the requirements exceed the capacity of the district frame. The capacity of the district and office frames as well as the provision of trunk and overflow terminals within the banks, is similar. Office frames are separated into a number of groups known as office multiples. Each office multiple contains outgoing trunk capacity to a particular group of offices and consists of one or more office frames. The number of office multiples provided is dependent on the number of offices to be served and the number of trunks required to those offices. In large exchanges it may be necessary to provide several office multiples with a number of office frames in each multiples. Figure 5-12 shows the trunking between district and office frames.

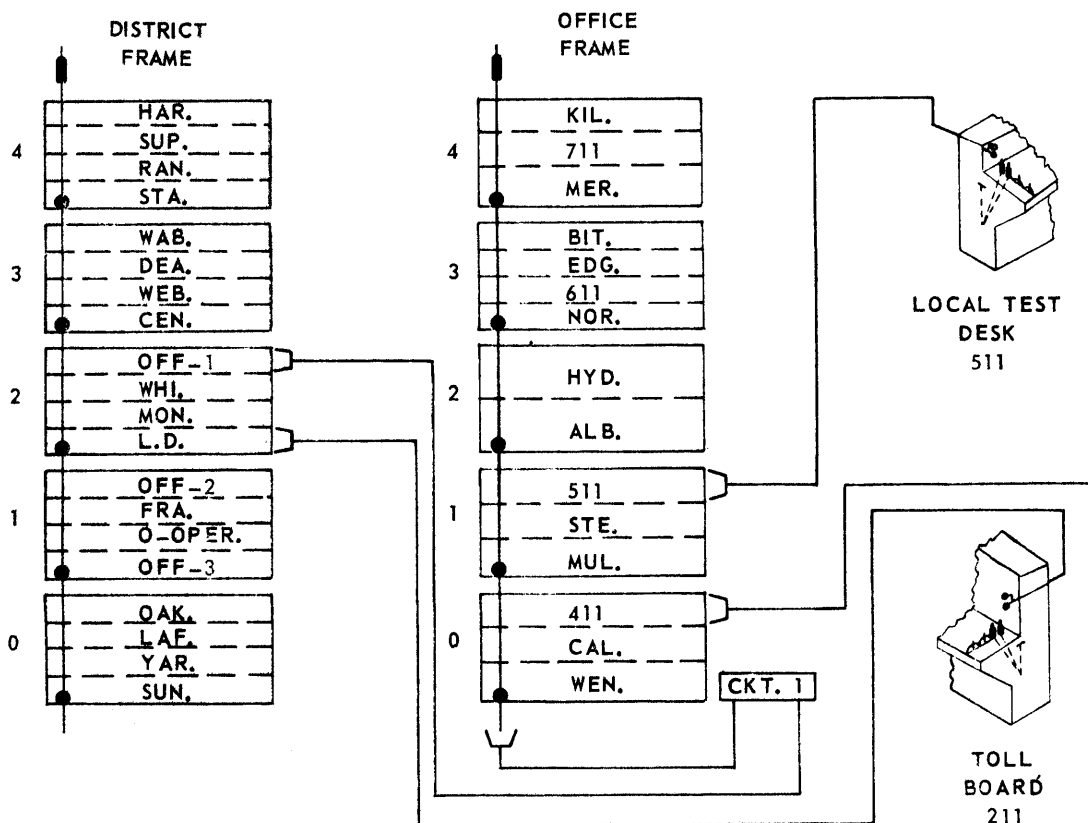

Figure 5-12 Trunking Between District and Office Frames

D. INCOMING FRAME

The purpose of the incoming frame is to make connection between a path or trunk incoming from a dial or manual office to equipment serving a particular 500 numbers. It also supplies the proper ringing current to ring the called station when the line has been selected on the final frame. This frame is similar to the district frame in that it contains five banks of 100 terminals per bank and capacity for 60 selectors. It differs, however, in that each bank is made up of four groups of terminals consisting of 24 trunk terminals and one overflow terminal. Thus, 500 terminals are arranged to provide 20 groups or choices, each of which has access to equipment serving 500 numbers, or a maximum capacity of 10,000 numbers or terminals for a full sized unit. Figure 5-13 shows the trunking between incoming and final frames. Due to circuit requirements, separate groups of incoming selectors are provided for handling calls from dial, manual and toll offices.

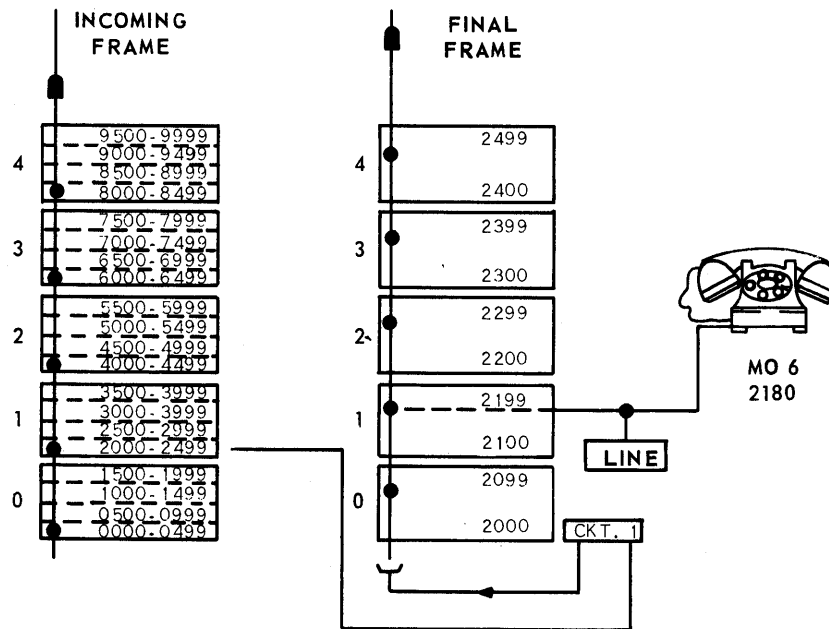

Figure 5-13 Trunking Between Incoming and Final Frames

### E. FINAL FRAME

The final frame is the last step in the connection of a call to a dial telephone. Its function is to make a connection between the path from the incoming frame and the terminal of the called station. This frame is similar to the district and incoming frames in that it contains five banks of 100 terminals per bank and capacity for 60 selectors. However, instead of the multiple banks of trunk terminals, this frame has multiple banks of subscribers' terminals. On district, office and incoming frames the selector picks an idle terminal in a particular group while on the final frame, the selector picks a particular terminal corresponding to a subscriber's number; that is, it is of the particular-terminal selecting type rather than of the hunting type. In the case of a P.B.X. or multi-line group the wiring is so arranged that the final selector selects the first idle trunk in the P.B.X. group.

Normally, one final frame with capacity for 60 final selectors is sufficient to handle calls for a particular group of 500 numbers. However, more than one frame can be provided if conditions require more than 60 selectors. For example, if more than 60 and less than 90 final selectors are required, one final frame bridged with one-half of another constitutes a final choice. Similarly, two final frames can be bridged together, giving a maximum of 120 final selectors for a choice. Also, if less than 60 selectors are required, two-thirds or one-half of a frame can be utilized to make up a final choice.

### F. SENDER CONNECTORS

#### (a) Sender Selector

In older offices, a branch of the line finder-district selector circuit terminates on the brushes of a rotary type switch known as a "sender selector." This switch is provided with a semi-circular multiple bank, upon the multiple contacts of which terminate trunks leading to a maximum group of 22 senders. The purpose of this switch is to select an idle sender and associate it with a line finder-district selector unit (that is, with the

calling line) when a call is initiated. The group of senders is multiplied through the banks of as many sender selectors as will constitute a load for the sender group. The sender selector is of the "stay-put" type, that is, it does not return to normal after it has completed its functions. When it is used on a second call it starts to test for an idle sender at the point where a sender was connected on the previous call. Figure 5-12 shows the relative position of the sender selector in the train of selection.

(b) Panel Link Frame

A later development in the panel system utilizes a link in place of a sender selector as a means for associating a sender with a line finder-district selector unit. The link permits the use of larger groups of senders with consequent reduction in the total number of senders required. The earlier type or rotary link gives access to a group of 44 senders while the latest type of panel link gives access to a group of 100 senders. The general operation of both types is similar, the rotary type utilizing rotary switches and the panel type utilizing selectors and multiple banks.

The link is a double-ended type of selector and is mounted on a link frame which has capacity for 30 links. One end of the link has access to a sender selector bank with capacity for 100 sets of terminals and the other end has access to a district finder bank with capacity for 20 or 40 sets of line finder-district selector circuits. Both of these banks are mounted on the link frame. The smaller size district finder bank is used for line finder groups of 28 or 40 units while the larger bank is used for groups of 60 or 80 line finders.

### G. SENDER

The sender is the unit of equipment which controls the establishment of a connection through the required selectors and trunks. Each sender comprises relays and other apparatus mounted in metal cabinets and 11 rotary switches and 6 sequence switches mounted outside the cabinet. Sender operation is electro-mechanical.

As previously mentioned, in the panel system, direct control of the switches by the subscriber's dial is abandoned. It is the function of the sender - 1) to record and hold the number dialed, 2) convert it into terms of selector, brush and group selections and 3) control the selectors in accordance with them. The sender, therefore, is the major control element of the panel system.

When a sender has been connected to a subscriber's line through the link frame, dial tone is returned to the subscriber which signals him to start circuit impulses which operate the line relay and, through its contacts, a chain of sensitive relays. While these relays are able to follow the rapid pulses, they do not have enough contacts to store them. At the end of each train of pulses which comprise a digit, the information dialed is transferred to a train of register relays and the counting relays return to normal to follow the next train of pulses. As many as eight trains of register relays are provided to accommodate a 3-digit office code, a 4-digit number and a party letter, and each train is called in successively to record and store the successive digits.

When the first three digits representing the office code have been dialed, recorded and stored, the sender calls in a decoder. The decoder looks at the first three digits and determines the location of the called office trunks on the district frame. This information is passed back to the sender over six relay control leads. While this operation was in process, the sender was accepting the remaining digits from the dialing station.

### H. DECODER CONNECTOR FRAME

The decoder completes its operations in about 0.3 seconds so that one decoder may serve many calls if it is connected into a circuit only during the time it is



required. This is accomplished by the decoder connector. Dependent upon the number of senders and decoders, arrangements are provided so that all senders have access to all decoders on a preference basis. This prevents loading up one decoder. The connections are completed through relay chains and are released upon completion of the decoder function.

#### I. DECODER

As previously discussed, the sender is connected to the decoder and submits to it the three-digit office code. The office code is registered and checked in the decoder and then, through a translating relay chain, a particular route relay is operated, one of 800 possible choices. The route relay in operating, grounds six leads which terminate on the cross-connecting frame and which are designated by the letters "CL," "DB," "DG," "OB," "OG," and "CR." These indications are transferred back to the sender where they are locked into the sender register. The sender then sends a disconnect signal which results in restoring the decoder and disconnecting it.

#### J. EQUIPMENT FOR DIRECT DISTANCE DIALING

##### (a) The Auxiliary Sender

The auxiliary sender is a wire-spring relay equipment unit, four of which mount in a single frame. It is used in a decoder panel office to provide the Direct Distance Dialing feature for the subscribers. The auxiliary sender registers the last two digits on a 10-digit DDD call, thus supplementing the eight-digit capacity of the subscriber sender in the Panel office. When the outgoing trunk is selected, the auxiliary sender tests to make sure a remote incoming sender is attached. It then signals the subscriber sender to pass the eight digits stored in it on a PCI basis to the auxiliary sender. The auxiliary sender outputpulses to the distant office on a multifrequency basis. With the completion of outputpulsing, it notifies the subscriber sender so that both senders may release. Figure 5-14 shows a block diagram of auxiliary senders applied to a Panel Office.

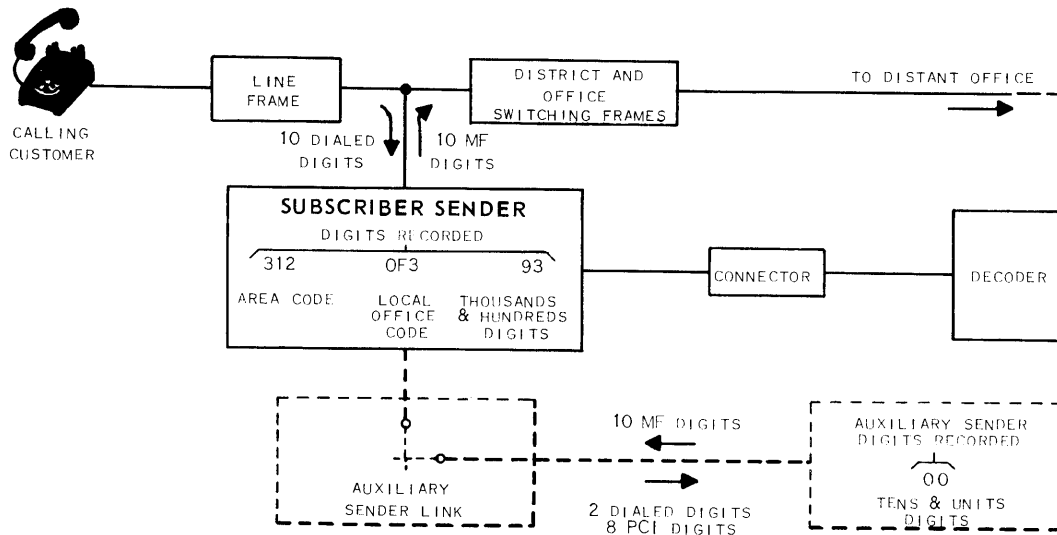

Figure 5-14 Block diagram of auxiliary sender applied to a panel central office.

(b) The Auxiliary Sender Link

The auxiliary sender link provides the connecting path between any one of a maximum of 100 subscriber senders and their associated auxiliary senders. This frame may be partially equipped in individual units, each with capacity for ten subscriber senders and, when fully equipped, consists of ten auxiliary sender link units. An auxiliary sender link unit consists of a 200-point, 6-wire crossbar switch with associated relays. The senders appear on the verticals of the unit, two verticals per sender. The auxiliary senders appear on the horizontals and may be multiplied over as many link units on as many link frames, as the auxiliary sender traffic will permit.

To provide a certain degree of service protection, the senders in the same sender group should be spread over two or more

auxiliary sender link frames. Duplicate control equipment is normally provided so that trouble in one frame will not affect service to senders appearing on the other link frame(s). It is also possible to split the senders on a particular auxiliary sender link frame between two groups of auxiliary senders by providing control circuits for each group.

#### 5.4 COMPLETION OF A FULL MECHANICAL CALL

Figure 5-15 is a block schematic diagram of all the elements of the panel system required to complete a call on a full mechanical basis.

The removal of the receiver from the hook operates the line circuit which in turn operates the line finder trip circuit, causing a horizontal trip rod on each side of the frame, opposite the bank in which this line appears, to operate. Two trip rods are required because the line finders available to any subscriber are on both sides of the frame and the trip rod must engage with the proper brush of any line finder that the link circuit may have previously selected to handle the call.

As soon as the trip rod has operated, the trip circuit operates the start circuit, which operated the up-drive of the line finder clutch through the wiring of the links associated with this group of 400 subscribers' lines and the line finder-district wiring. The selector rod rises, tripping the brush opposite the bank in which the subscriber's line appears.

As soon as the selector rod brush has been tripped, the start circuit is released for other service. In any particular group of line finders only one finder can start up-drive at a time.

After the line finder has been started it continues upward until the tripped brush makes contact with the terminals of the calling line which causes its upward travel to stop. When the line finder started upward, a sender selector on the link frame also started upward to hunt for an idle sender, if not already resting on one.

The sender immediately sends dial tone through the sender selector and district finder of the link circuit, through the line finder-district wiring and line finder to the calling subscriber. The subscriber on hearing dial tone proceeds to dial the office code and number which is registered in the sender.

As the subscriber dials, the pulses are received by pulse control relays and as soon as each train or series is completed, the pulses control relays which cause the register relays to register the number of pulses counted by the pulse control relays. As each set of relays make their registration, they close a path to make the next registration take place in succeeding register relays.

As soon as the office code letters have been registered and the decoder connector which serves this sender is idle, the decoder connector is caused to select an idle decoder. After the connector has found an idle decoder, it connects the code letters relays through to the decoder for the purpose of informing it of which office is being called.

When the decoder has been notified which office has been called, it registers in the sender a record of the position of the terminals of trunks to that office. This record appears on the district brush, district group, office brush, and office group (marked DB, DG, OB, and OG), groups of relays via the decoder connector. As soon as the decoder outpulses DB to OG it causes itself to be released.

During the time the decoder is used and the time taken for the selections described later to be made, the subscriber continues to operate his dial until the desired number has been completely dialed. As each code letter or digit is dialed the pulses are counted and locked into the next and proper register relays. After the decoder has been disconnected from the sender enough information has been received to start selecting a trunk to the desired office, so the selection control causes the district to start brush selection, governed by the sender's selection circuit through the setting of the DB relays.

There are three steps taken by the district selector in selecting an idle trunk; i.e., first, the selection of the brush on whose bank the trunks to the called office

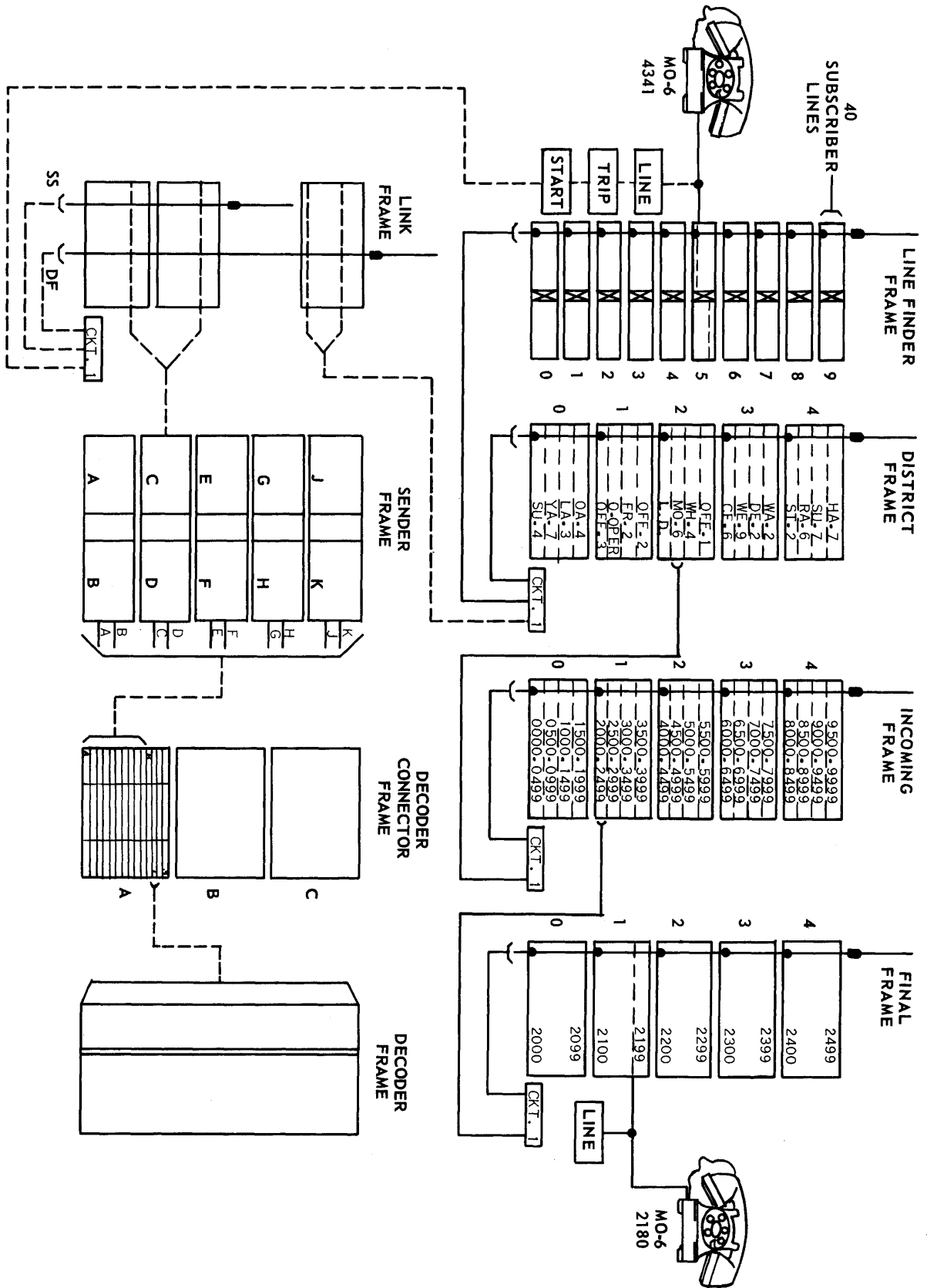

Figure 5-15 Plan of Direct Mechanical Selection

appear (called district brush selection); second, the passing over all trunks to other offices that may appear lower on the bank (called group selection); and third, the picking of the first idle trunk (called trunk hunting).

The sender having found from the decoder which brush to trip causes the district elevator to up-drive to a position where a trip finger on the trip rod will engage with the trip lever of the brush to be tripped when the trip rod operates. In order that the sender can exactly control the height of rise by the elevator, the progress for brush selection is indicated to the sender by means of "A" commutator segments at the top of the selector. Figure 5-16 shows the "A" segments of the commutator used on the district selector.

As the elevator is moved up under control of the sender, the "A" commutator spring, moving with it, passes over "A" commutator segments. The "A" spring when sliding over each segment causes a pulse to be sent to the sender, whose selection control circuit counts or registers the pulses. As soon as the sender receives as many pulses as are recorded to be needed for the DB selection (DB relay group set by decoder) it stops the up-drive of the district elevator. The clutch pawl engages with the rack and upon operation of the trip magnet the proper trip finger engages with a brush trip lever. At this time the brushes have not yet come opposite any bank terminals but have risen only far enough for brush selection. After brush selection the elevator continues for other selections.

Group selection is also governed by the registration in the sender from the decoder through the use of commutator segments and the selection control circuit. The metal commutator strip "B" (Figure 5-17) is used for group selection and is mounted with commutator "A" and other commutator strips in the surface of the insulating base of the commutator. It has a number of segments 0, 1, 2, etc., corresponding to the group or layer division of each multiple bank. The length of the commutator strip "B" corresponds to the height of the 100 terminals in a multiple bank, and the distance between the first sets of terminals of adjacent multiple layers or groups. This is illustrated in Figure 5-17, where the commutator is placed opposite a bank of multiple terminals so as to show the relation between the first terminal of

each layer or group and their respective commutator segments. Commutator brush "B" is arranged to make contact with these segments as the elevator moves upward for group selection. Each time the spring makes contact with a segment it sends a pulse to the selection control circuit of the sender, where it is counted or registered, and when the number of pulses equal the number recorded as necessary for district group selection in the sender by the decoder, the up-drive is stopped. This leaves the tripped brush in contact with the first trunk in the group to the desired office. As soon as the brush reaches the level of the first trunk in the desired group it comes under the control of the trunk hunting circuit and continues to rise until it reaches the first idle trunk in the group.

Some offices have their trunks appear in the groups on the banks of an office frame, in which case a trunk to an office circuit is selected by the district office. After the office selector circuit has been picked, the sender directs the office selector into contact with a trunk to the desired office in exactly the same manner as a district selector is directed into contact with a trunk. The sender for office selections uses the registration received from the decoder by the OB and OG groups of relays.

The incoming selector circuit which the district (or office) selector has chosen may be on a frame at the same office in which the call originated or any other dial system office.

For terminating connections, the subscriber's lines are multiplied on the banks of final frames in groups of five hundred. This makes it necessary that a final selector be used that has access to the group of 500 lines where the called line appears. The incoming selector chooses the selector on the proper final frame.

As there are twenty final choices of usually one frame each in a complete central office unit of 10,000 lines, the terminals on the incoming banks are divided into twenty layers or groups, four groups to each bank. There are 100 terminals in each bank; therefore, in each group on an incoming bank there are twenty-five terminals, twenty-four of which are terminals of trunks to final selectors, the other being an overflow set of terminals. In order that connection can be made to terminals in any one of the five banks, brush selection must be made.

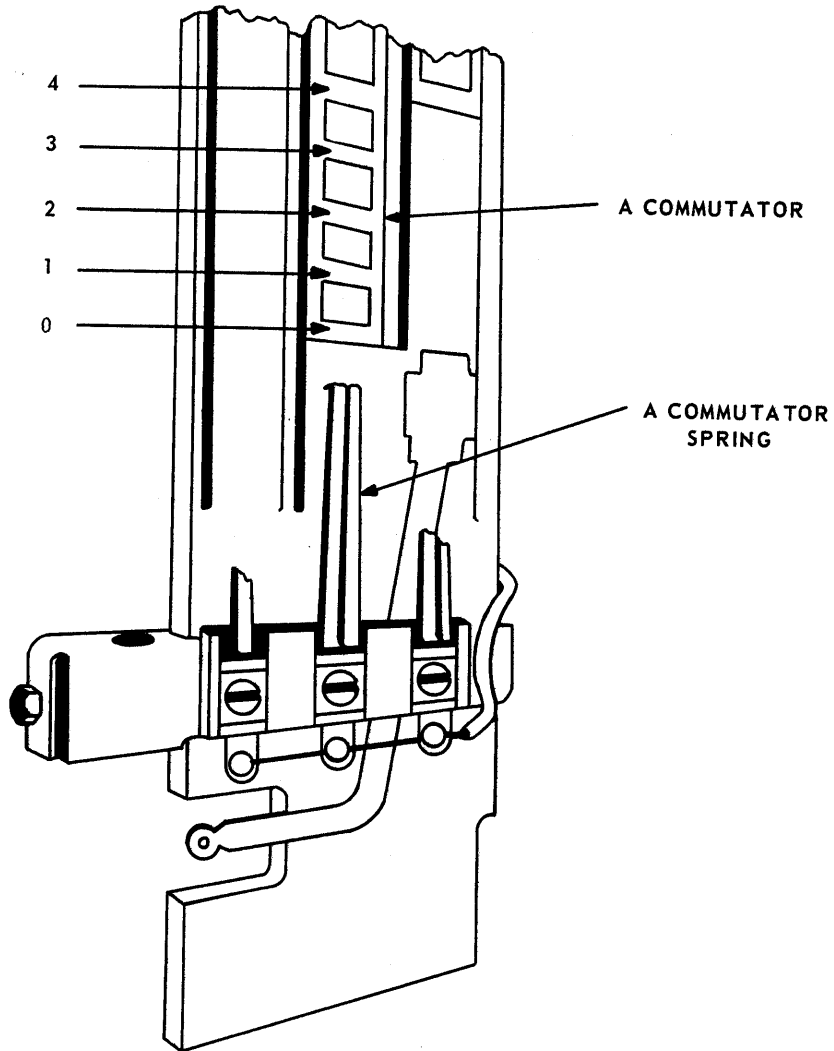

Figure 5-16 "A" Commutator Segments



The sender, as soon as an idle trunk to an incoming frame is found, registers the number of the brush and group to be used on the incoming frame on its IB and IG groups of relays as determined by the setting of the TH and H pulse registering relays. The selection control circuit can then direct the incoming elevator up for brush selection, counting pulses from the "A" segments just as it did for district brush selection and office brush selection.

After the incoming elevator has risen far enough and stopped in position for the proper trip finger to engage with the brush trip lever, it must rise again for group selection to trip the brush and connect to the first set of terminals in the group to which the trunks to the proper final frame are connected. The selection control circuit starts the elevator upward and counts pulses, until the number received from the "B" commutator segments agrees with the registration on the IG group of relays. The method of group selection, as well as brush selection, is identical with brush and group selections of the district and office selectors, only the number and spacing of "B" commutator segments being different.

When the incoming elevator stops on the first terminals of a group, it immediately starts up again if the trunk sleeve terminal is connected to ground; which indicates that the trunk is busy. When an open condition is found on a sleeve terminal, the incoming elevator is stopped and remains in contact with that set of terminals. This leaves a connection established through which final selections now take place.

As the called subscriber's line may be in any one of the five banks, the final frame must make brush selection through use of "A" commutator segments just the same as the district office, or incoming selector does, except that the sender gets its information from the registration in the "H" group of register relays.

When brush selection has been completed the sender directs the final brush up for group or tens selection, the selected group depending on the registration in the "T" group of register relays. Tens selection is made in the same way that group selection is made on district, office or incoming selectors. The "B" commutator segments are numbered from 0 to 9 and are so positioned that they correspond to every tenth subscriber's line terminal

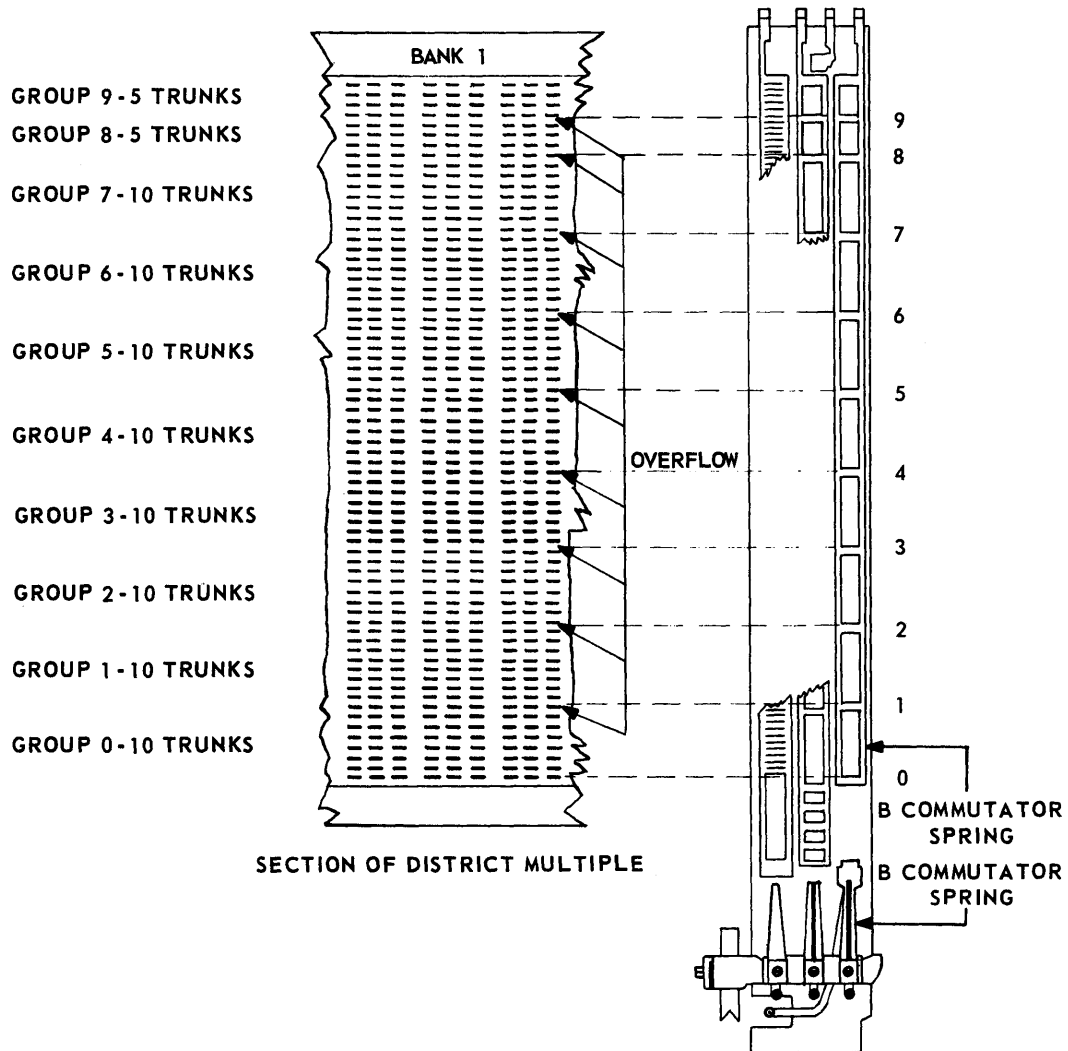

Figure 5-17 District Brush Selection

on the banks. By this arrangement when the sender has counted the proper number of pulses from the "B" commutator it stops the final elevator, leaving the tripped brush on a line whose number ends in 00, 10, 20, 30, 40, 50, 60, 70, 80 or 90. The wires to the brush are open circuited in the final wiring at this time so that such lines are undisturbed while units selection drives the elevator up again from 1 to 9 terminals if necessary for connection to the called line as determined by the units digit of the dialed number.

Units selection is under control of the sender, which counts pulses from the "U" commutator segments and when the number of pulses properly match the number registered on the "U" register relays it stops the up-drive, leaving the final selector on the called line.

When selections have been completed, the link discharges the sender and selects an idle line finder-district circuit to be used later when that link's turn to be used arrives again.

The talking path is closed between the line finder and the district selector under control of the sender just before it is discharged, completing the connection between the calling and called subscribers. Intermittent ringing current is then applied automatically by the incoming selector to the called subscriber's line until he removes the receiver.

When the conversation is finished, replacing the receivers on the hooks causes all selectors through which talking occurs to return to normal, where they await reselection for another call.

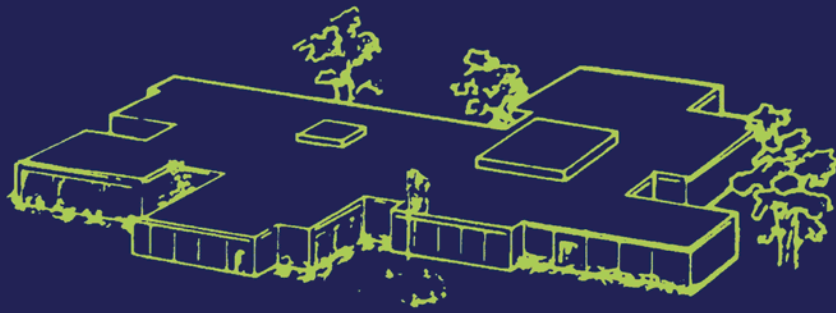

**Western Electric**